

NTMD6P02R2

Preferred Device

Power MOSFET 6 Amps, 20 Volts P-Channel SOIC-8, Dual

Features

- Ultra Low $R_{DS(on)}$
- Higher Efficiency Extending Battery Life
- Logic Level Gate Drive
- Miniature Dual SOIC-8 Surface Mount Package
- Diode Exhibits High Speed, Soft Recovery
- Avalanche Energy Specified
- SOIC-8 Mounting Information Provided
- Pb-Free Packages are Available

Applications

- Power Management in Portable and Battery-Powered Products, i.e.: Cellular and Cordless Telephones, and PCMCIA Cards

MAXIMUM RATINGS

Rating	Symbol	Value	Unit
Drain-to-Source Voltage	V_{DS}	-20	V
Gate-to-Source Voltage – Continuous	V_{GS}	± 12	V
Thermal Resistance – Junction-to-Ambient (Note 1)	$R_{\theta JA}$	62.5	$^{\circ}\text{C}/\text{W}$
Total Power Dissipation @ $T_A = 25^{\circ}\text{C}$	P_D	2.0	W
Continuous Drain Current @ $T_A = 25^{\circ}\text{C}$	I_D	-7.8	A
Continuous Drain Current @ $T_A = 70^{\circ}\text{C}$	I_D	-5.7	A
Maximum Operating Power Dissipation	P_D	0.5	W
Maximum Operating Drain Current	I_D	-3.89	A
Pulsed Drain Current (Note 4)	I_{DM}	-40	A
Thermal Resistance – Junction-to-Ambient (Note 2)	$R_{\theta JA}$	98	$^{\circ}\text{C}/\text{W}$
Total Power Dissipation @ $T_A = 25^{\circ}\text{C}$	P_D	1.28	W
Continuous Drain Current @ $T_A = 25^{\circ}\text{C}$	I_D	-6.2	A
Continuous Drain Current @ $T_A = 70^{\circ}\text{C}$	I_D	-4.6	A
Maximum Operating Power Dissipation	P_D	0.3	W
Maximum Operating Drain Current	I_D	-3.01	A
Pulsed Drain Current (Note 4)	I_{DM}	-35	A
Thermal Resistance – Junction-to-Ambient (Note 3)	$R_{\theta JA}$	166	$^{\circ}\text{C}/\text{W}$
Total Power Dissipation @ $T_A = 25^{\circ}\text{C}$	P_D	0.75	W
Continuous Drain Current @ $T_A = 25^{\circ}\text{C}$	I_D	-4.8	A
Continuous Drain Current @ $T_A = 70^{\circ}\text{C}$	I_D	-3.5	A
Maximum Operating Power Dissipation	P_D	0.2	W
Maximum Operating Drain Current	I_D	-2.48	A
Pulsed Drain Current (Note 4)	I_{DM}	-30	A
Operating and Storage Temperature Range	T_J, T_{stg}	-55 to +150	$^{\circ}\text{C}$
Single Pulse Drain-to-Source Avalanche Energy – Starting $T_J = 25^{\circ}\text{C}$ ($V_{DD} = -20$ Vdc, $V_{GS} = -5.0$ Vdc, Peak $I_L = -5.0$ Apk, $L = 40$ mH, $R_G = 25$ Ω)	E_{AS}	500	mJ
Maximum Lead Temperature for Soldering Purposes for 10 seconds	T_L	260	$^{\circ}\text{C}$

Stresses exceeding Maximum Ratings may damage the device. Maximum Ratings are stress ratings only. Functional operation above the Recommended Operating Conditions is not implied. Extended exposure to stresses above the Recommended Operating Conditions may affect device reliability.

1. Mounted onto a 2" square FR-4 Board (1 in sq, 2 oz. Cu 0.06" thick single sided), $t = 10$ seconds.
2. Mounted onto a 2" square FR-4 Board (1 in sq, 2 oz. Cu 0.06" thick single sided), $t =$ steady state.
3. Minimum FR-4 or G-10 PCB, $t =$ steady state.
4. Pulse Test: Pulse Width = 300 μs , Duty Cycle = 2%.



ON Semiconductor®

<http://onsemi.com>

6 AMPERES, 20 VOLTS

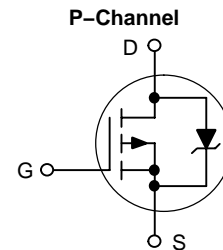

MARKING DIAGRAM & PIN ASSIGNMENT



SOIC-8
CASE 751
STYLE 11

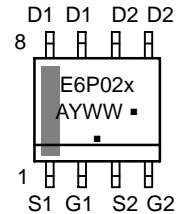

E6P02 = Specific Device Code
x = Blank or S
A = Assembly Location
Y = Year
WW = Work Week
▪ = Pb-Free Package

(Note: Microdot may be in either location)

ORDERING INFORMATION

Device	Package	Shipping†
NTMD6P02R2	SOIC-8	2500 / Tape & Reel
NTMD6P02R2G	SOIC-8 (Pb-Free)	2500 / Tape & Reel
NTMD6P02R2SG	SOIC-8 (Pb-Free)	2500 / Tape & Reel

†For information on tape and reel specifications, including part orientation and tape sizes, please refer to our Tape and Reel Packaging Specifications Brochure, BRD8011/D

Preferred devices are recommended choices for future use and best overall value.

NTMD6P02R2

ELECTRICAL CHARACTERISTICS (T_C = 25°C unless otherwise noted)*

Characteristic	Symbol	Min	Typ	Max	Unit
----------------	--------	-----	-----	-----	------

OFF CHARACTERISTICS

Drain-to-Source Breakdown Voltage (V _{GS} = 0 Vdc, I _D = -250 μAdc) Temperature Coefficient (Positive)	V _{(BR)DSS}	-20 -	- -11.6	- -	Vdc mV/°C
Zero Gate Voltage Drain Current (V _{DS} = -20 Vdc, V _{GS} = 0 Vdc, T _J = 25°C) (V _{DS} = -20 Vdc, V _{GS} = 0 Vdc, T _J = 70°C)	I _{DSS}	- -	- -	-1.0 -5.0	μAdc
Gate-Body Leakage Current (V _{GS} = -12 Vdc, V _{DS} = 0 Vdc)	I _{GSS}	-	-	-100	nAdc
Gate-Body Leakage Current (V _{GS} = +12 Vdc, V _{DS} = 0 Vdc)	I _{GSS}	-	-	100	nAdc

ON CHARACTERISTICS

Gate Threshold Voltage (V _{DS} = V _{GS} , I _D = -250 μAdc) Temperature Coefficient (Negative)	V _{GS(th)}	-0.6 -	-0.88 2.6	-1.20 -	Vdc mV/°C
Static Drain-to-Source On-State Resistance (V _{GS} = -4.5 Vdc, I _D = -6.2 Adc) (V _{GS} = -2.5 Vdc, I _D = -5.0 Adc) (V _{GS} = -2.5 Vdc, I _D = -3.1 Adc)	R _{DS(on)}	- - -	0.027 0.038 0.038	0.033 0.050 -	Ω
Forward Transconductance (V _{DS} = -10 Vdc, I _D = -6.2 Adc)	g _{FS}	-	15	-	Mhos

DYNAMIC CHARACTERISTICS

Input Capacitance	(V _{DS} = -16 Vdc, V _{GS} = 0 Vdc, f = 1.0 MHz)	C _{ISS}	-	1380	1700	pF
Output Capacitance		C _{OSS}	-	515	775	
Reverse Transfer Capacitance		C _{RSS}	-	250	450	

SWITCHING CHARACTERISTICS (Notes 5 and 6)

Turn-On Delay Time	(V _{DD} = -10 Vdc, I _D = -1.0 Adc, V _{GS} = -10 Vdc, R _G = 6.0 Ω)	t _{d(on)}	-	15	25	ns
Rise Time		t _r	-	20	50	
Turn-Off Delay Time		t _{d(off)}	-	85	125	
Fall Time		t _f	-	50	110	
Turn-On Delay Time	(V _{DD} = -16 Vdc, I _D = -6.2 Adc, V _{GS} = -4.5 Vdc, R _G = 6.0 Ω)	t _{d(on)}	-	17	-	ns
Rise Time		t _r	-	65	-	
Turn-Off Delay Time		t _{d(off)}	-	50	-	
Fall Time		t _f	-	80	-	
Total Gate Charge	(V _{DS} = -16 Vdc, V _{GS} = -4.5 Vdc, I _D = -6.2 Adc)	Q _{tot}	-	20	35	nC
Gate-Source Charge		Q _{gs}	-	4.0	-	
Gate-Drain Charge		Q _{gd}	-	8.0	-	

BODY-DRAIN DIODE RATINGS (Note 5)

Diode Forward On-Voltage	(I _S = -1.7 Adc, V _{GS} = 0 Vdc) (I _S = -1.7 Adc, V _{GS} = 0 Vdc, T _J = 125°C)	V _{SD}	- -	-0.80 -0.65	-1.2 -	Vdc
Diode Forward On-Voltage	(I _S = -6.2 Adc, V _{GS} = 0 Vdc) (I _S = -6.2 Adc, V _{GS} = 0 Vdc, T _J = 125°C)	V _{SD}	- -	-0.95 -0.80	- -	Vdc
Reverse Recovery Time	(I _S = -1.7 Adc, V _{GS} = 0 Vdc, dI _S /dt = 100 A/μs)	t _{rr}	-	50	80	ns
		t _a	-	20	-	
		t _r	-	30	-	
Reverse Recovery Stored Charge		Q _{RR}	-	0.04	-	μC

5. Indicates Pulse Test: Pulse Width = 300 μs max, Duty Cycle = 2%.

6. Switching characteristics are independent of operating junction temperature.

*Handling precautions to protect against electrostatic discharge are mandatory.

NTMD6P02R2

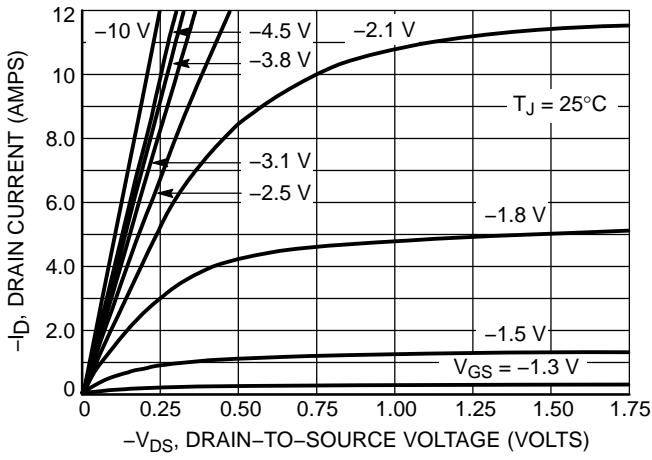

Figure 1. On-Region Characteristics

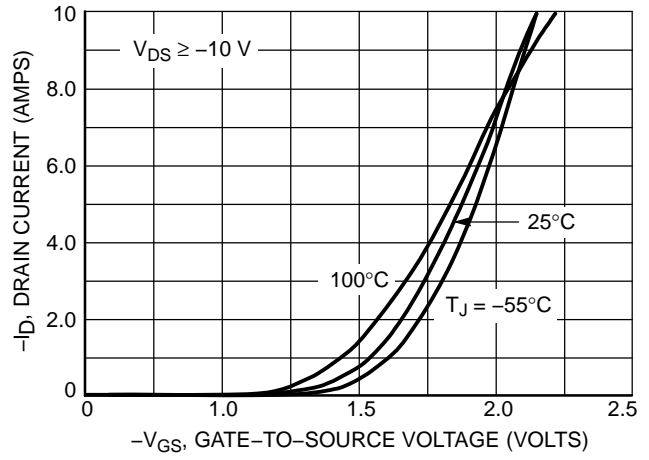

Figure 2. Transfer Characteristics

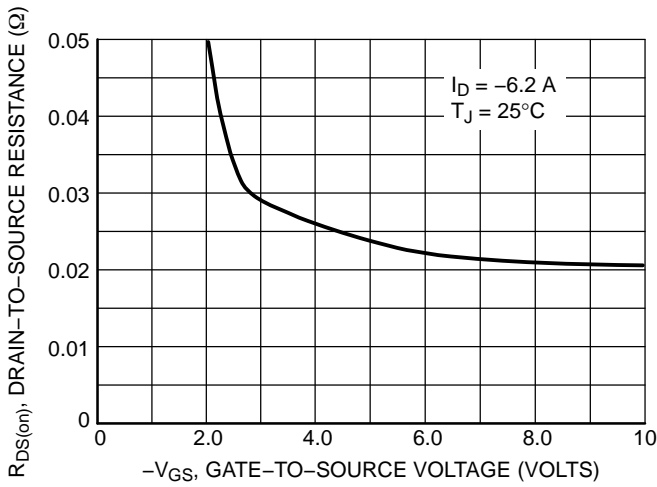

Figure 3. On-Resistance versus Gate-To-Source Voltage

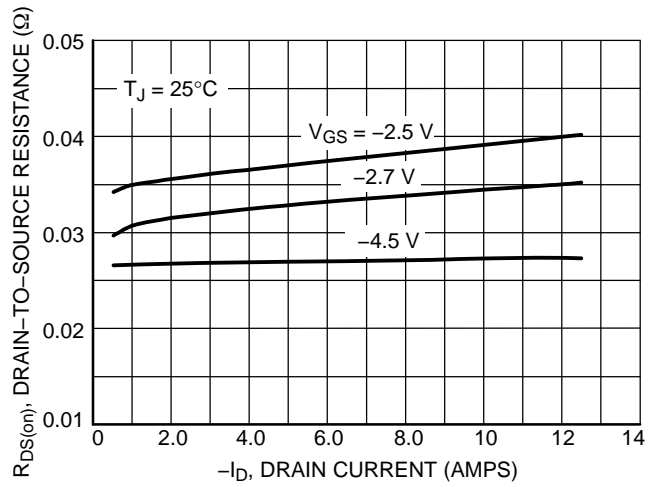

Figure 4. On-Resistance versus Drain Current and Gate Voltage

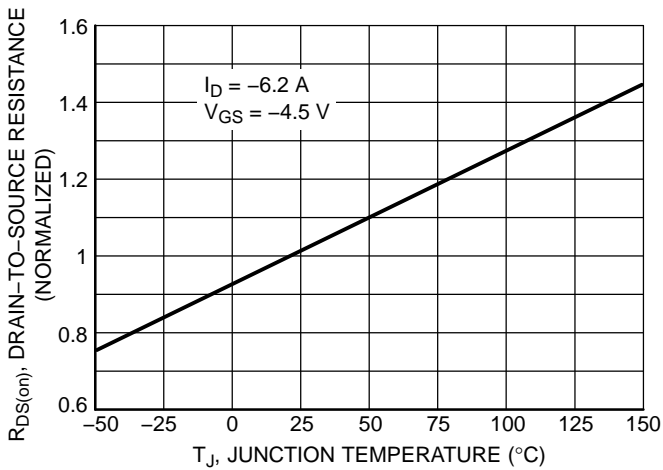

Figure 5. On-Resistance Variation with Temperature

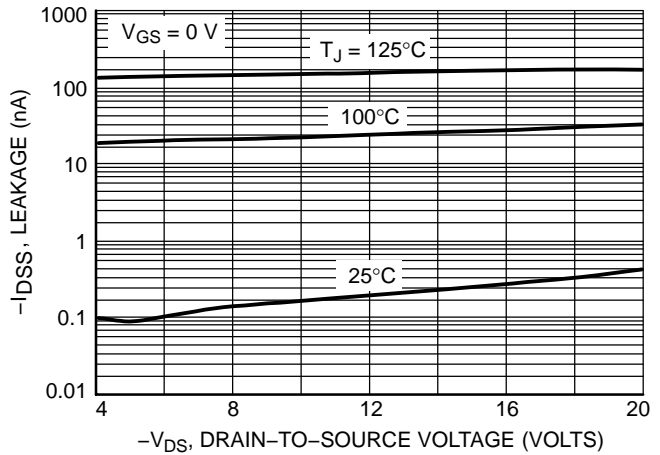
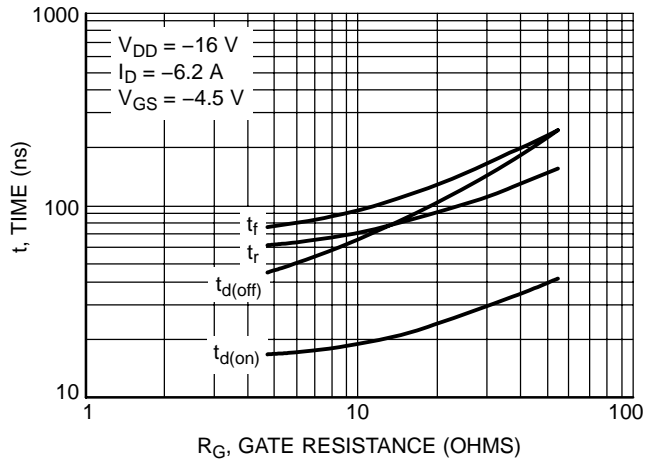
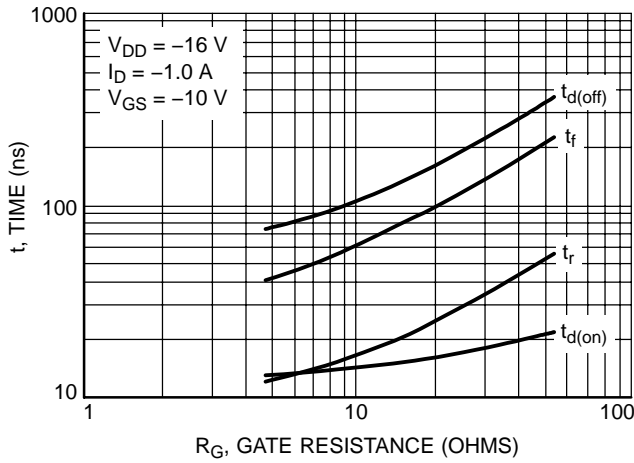
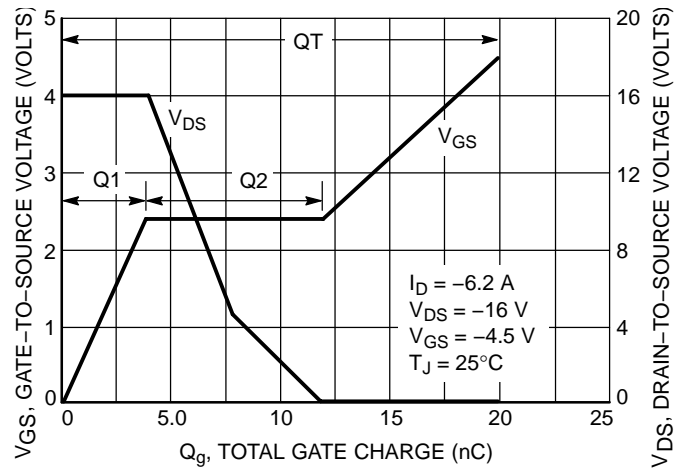
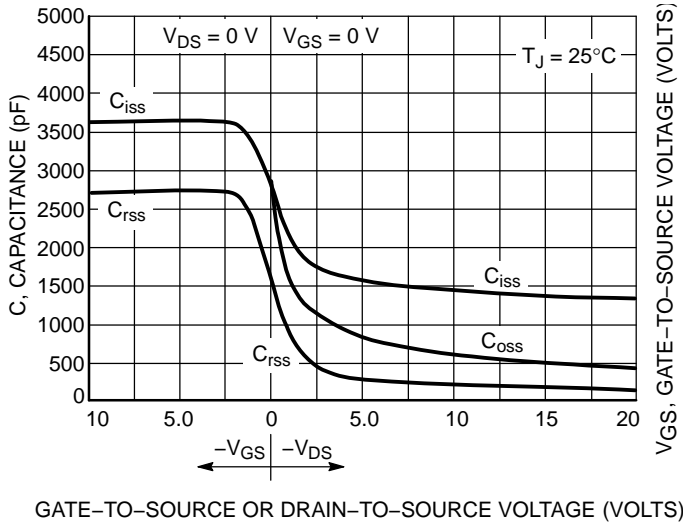
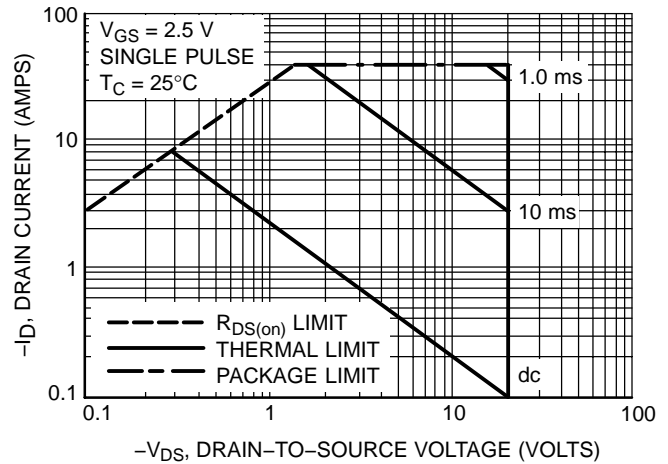
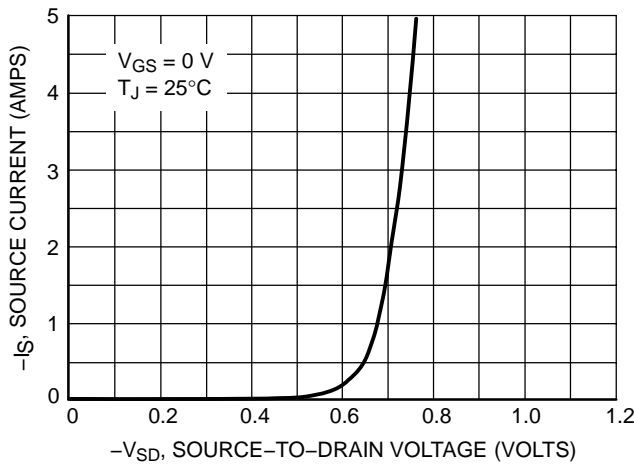

Figure 6. Drain-To-Source Leakage Current versus Voltage

NTMD6P02R2



DRAIN-TO-SOURCE DIODE CHARACTERISTICS



NTMD6P02R2

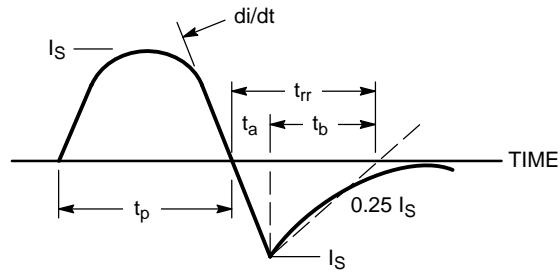

Figure 13. Diode Reverse Recovery Waveform

TYPICAL ELECTRICAL CHARACTERISTICS

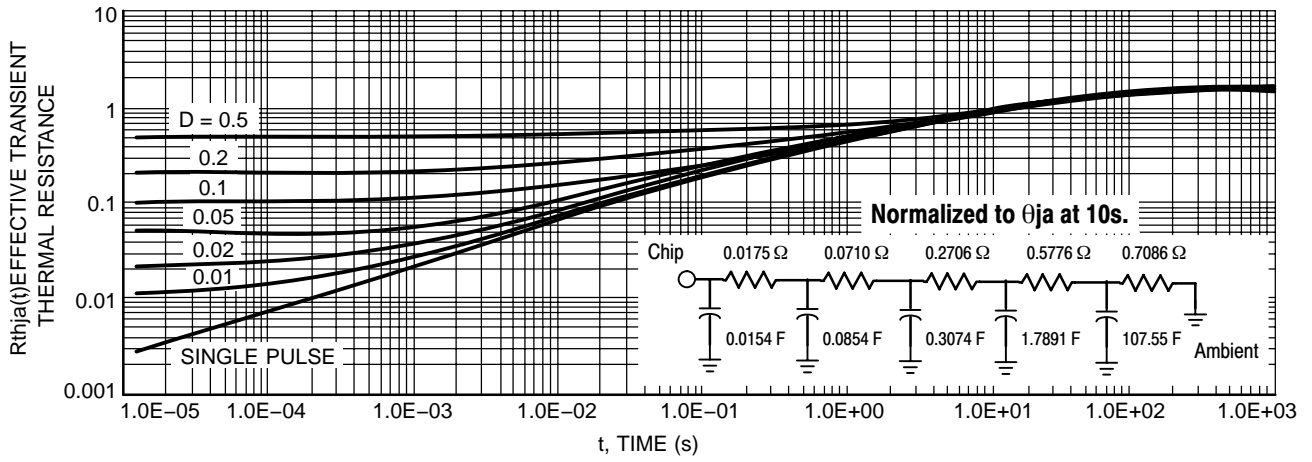
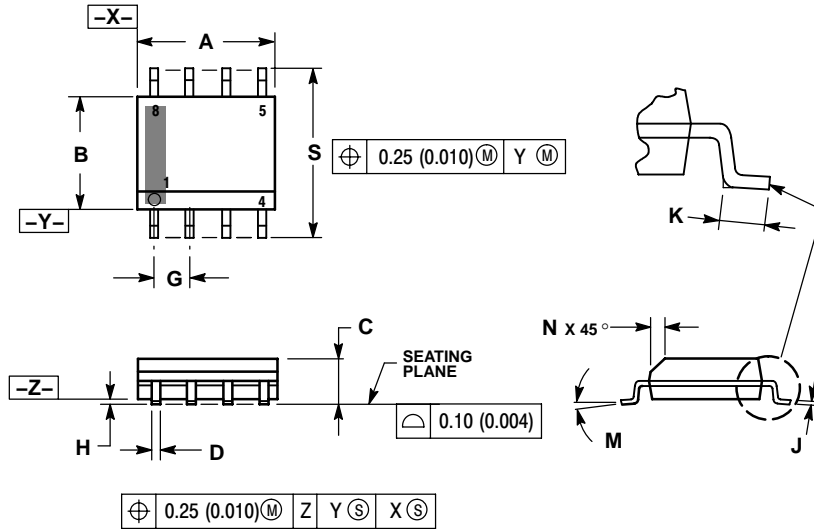

Figure 14. Thermal Response

NTMD6P02R2

PACKAGE DIMENSIONS

SOIC-8 NB
CASE 751-07
ISSUE AH



NOTES:

1. DIMENSIONING AND TOLERANCING PER ANSI Y14.5M, 1982.
2. CONTROLLING DIMENSION: MILLIMETER.
3. DIMENSION A AND B DO NOT INCLUDE MOLD PROTRUSION.
4. MAXIMUM MOLD PROTRUSION 0.15 (0.006) PER SIDE.
5. DIMENSION D DOES NOT INCLUDE DAMBAR PROTRUSION. ALLOWABLE DAMBAR PROTRUSION SHALL BE 0.127 (0.005) TOTAL IN EXCESS OF THE D DIMENSION AT MAXIMUM MATERIAL CONDITION.
6. 751-01 THRU 751-06 ARE OBSOLETE. NEW STANDARD IS 751-07.

DIM	MILLIMETERS		INCHES	
	MIN	MAX	MIN	MAX
A	4.80	5.00	0.189	0.197
B	3.80	4.00	0.150	0.157
C	1.35	1.75	0.053	0.069
D	0.33	0.51	0.013	0.020
G	1.27 BSC		0.050 BSC	
H	0.10	0.25	0.004	0.010
J	0.19	0.25	0.007	0.010
K	0.40	1.27	0.016	0.050
M	0°	8°	0°	8°
N	0.25	0.50	0.010	0.020
S	5.80	6.20	0.228	0.244

SOLDERING FOOTPRINT*

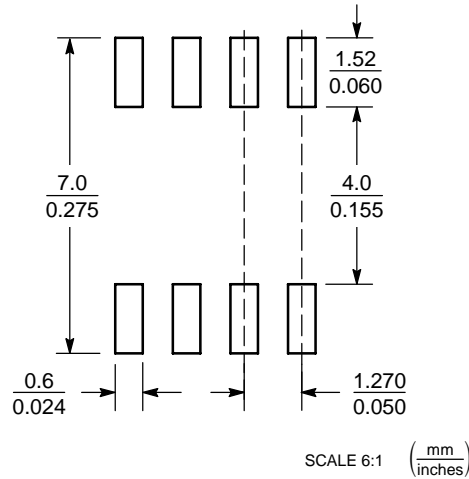

*For additional information on our Pb-Free strategy and soldering details, please download the ON Semiconductor Soldering and Mounting Techniques Reference Manual, SOLDERRM/D.

ON Semiconductor and are registered trademarks of Semiconductor Components Industries, LLC (SCILLC). SCILLC reserves the right to make changes without further notice to any products herein. SCILLC makes no warranty, representation or guarantee regarding the suitability of its products for any particular purpose, nor does SCILLC assume any liability arising out of the application or use of any product or circuit, and specifically disclaims any and all liability, including without limitation special, consequential or incidental damages. "Typical" parameters which may be provided in SCILLC data sheets and/or specifications can and do vary in different applications and actual performance may vary over time. All operating parameters, including "Typicals" must be validated for each customer application by customer's technical experts. SCILLC does not convey any license under its patent rights nor the rights of others. SCILLC products are not designed, intended, or authorized for use as components in systems intended for surgical implant into the body, or other applications intended to support or sustain life, or for any other application in which the failure of the SCILLC product could create a situation where personal injury or death may occur. Should Buyer purchase or use SCILLC products for any such unintended or unauthorized application, Buyer shall indemnify and hold SCILLC and its officers, employees, subsidiaries, affiliates, and distributors harmless against all claims, costs, damages, and expenses, and reasonable attorney fees arising out of, directly or indirectly, any claim of personal injury or death associated with such unintended or unauthorized use, even if such claim alleges that SCILLC was negligent regarding the design or manufacture of the part. SCILLC is an Equal Opportunity/Affirmative Action Employer. This literature is subject to all applicable copyright laws and is not for resale in any manner.

PUBLICATION ORDERING INFORMATION

LITERATURE FULFILLMENT:
Literature Distribution Center for ON Semiconductor
P.O. Box 5163, Denver, Colorado 80217 USA
Phone: 303-675-2175 or 800-344-3860 Toll Free USA/Canada
Fax: 303-675-2176 or 800-344-3867 Toll Free USA/Canada
Email: orderlit@onsemi.com

N. American Technical Support: 800-282-9855 Toll Free
USA/Canada
Europe, Middle East and Africa Technical Support:
Phone: 421 33 790 2910
Japan Customer Focus Center
Phone: 81-3-5773-3850

ON Semiconductor Website: www.onsemi.com
Order Literature: <http://www.onsemi.com/orderlit>

For additional information, please contact your local Sales Representative