

### FEATURES

- 10 MHz clock rate
- Second-order modulator
- 16 bits, no missing codes
- ±2 LSB INL typical at 16 bits
- 1.5  $\mu\text{V}/^\circ\text{C}$  typical offset drift
- On-board digital isolator
- On-board reference
- ±250 mV analog input range
- Low power operation: 15.5 mA typical at 5.5 V
- −40°C to +125°C operating range
- 8-lead surface-mount PDIP package with gull wing leads and 16-lead SOIC package
- [AD7401A](#), external clock version in 16-lead SOIC
- Safety and regulatory approvals
  - UL recognition
    - 3750 V rms for 1 minute per UL 1577
  - CSA Component Acceptance Notice #5A
  - VDE Certificate of Conformity
    - DIN V VDE V 0884-10 (VDE V 0884-10):2006-12
    - $V_{\text{IORM}} = 891 \text{ V peak}$

### APPLICATIONS

- AC motor controls
- Shunt current monitoring
- Data acquisition systems
- Analog-to-digital and opto-isolator replacements

### GENERAL DESCRIPTION

The AD7400A<sup>1</sup> is a second-order,  $\Sigma$ - $\Delta$  modulator that converts an analog input signal into a high speed, 1-bit data stream with on-chip digital isolation based on Analog Devices, Inc., iCoupler<sup>®</sup> technology. The AD7400A operates from a 5 V power supply and accepts a differential input signal of ±250 mV (±320 mV full scale). The analog input is sampled continuously by the analog modulator, eliminating the need for external sample-and-hold circuitry. The input information is contained in the output stream as a density of ones with a data rate of 10 MHz. The original information can be reconstructed with an appropriate digital filter. The serial I/O can use a 5 V or a 3 V supply ( $V_{\text{DD2}}$ ).

The serial interface is digitally isolated. High speed CMOS, combined with monolithic air core transformer technology, means the on-chip isolation provides outstanding performance characteristics superior to alternatives such as optocoupler devices. The part contains an on-chip reference and has an operating temperature range of −40°C to +125°C. The AD7400A is offered in an 8-lead surface-mount PDIP with gull wing leads and a 16-lead SOIC package.

<sup>1</sup> Protected by U.S. Patents 5,952,849; 6,873,065; and 7,075,329. Other patents are pending.

### FUNCTIONAL BLOCK DIAGRAM

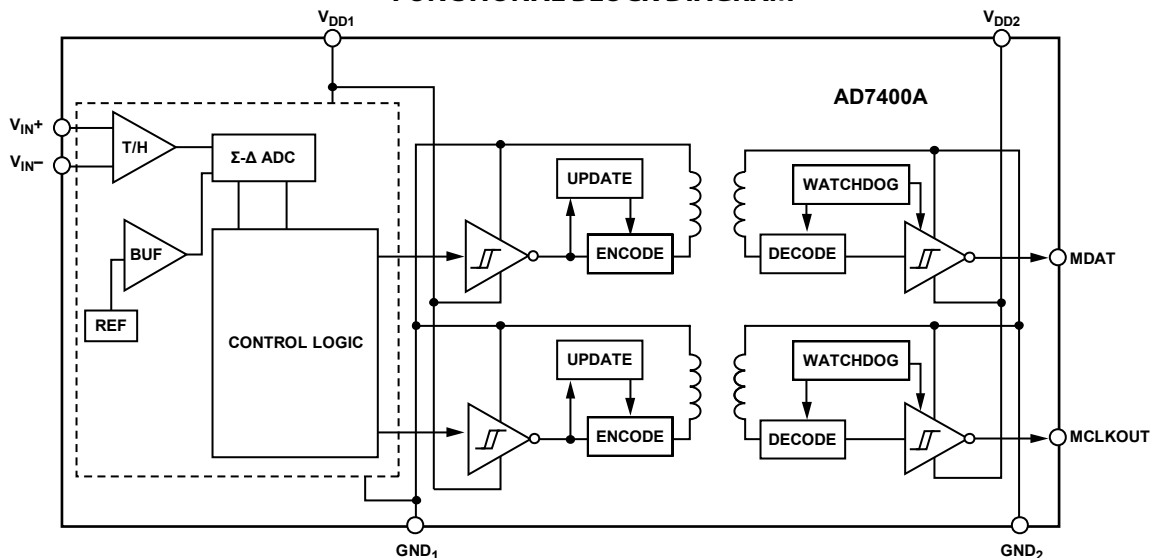

Figure 1.

#### Rev. A

Information furnished by Analog Devices is believed to be accurate and reliable. However, no responsibility is assumed by Analog Devices for its use, nor for any infringements of patents or other rights of third parties that may result from its use. Specifications subject to change without notice. No license is granted by implication or otherwise under any patent or patent rights of Analog Devices. Trademarks and registered trademarks are the property of their respective owners.

## TABLE OF CONTENTS

Features .....	1	Terminology .....	12
Applications.....	1	Theory of Operation .....	13
General Description .....	1	Circuit Information.....	13
Functional Block Diagram .....	1	Analog Input .....	13
Revision History .....	2	Differential Inputs .....	14
Specifications.....	3	Current Sensing Applications.....	14
Timing Specifications .....	4	Voltage Sensing Applications.....	14
Insulation and Safety-Related Specifications.....	5	Digital Filter .....	15
Regulatory Information.....	5	Applications Information .....	17
DIN V VDE V 0884-10 (VDE V 0884-10) Insulation		Grounding and Layout .....	17
Characteristics .....	6	Evaluating the AD7400A Performance .....	17
Absolute Maximum Ratings.....	7	Insulation Lifetime .....	17
ESD Caution.....	7	Outline Dimensions .....	18
Pin Configuration and Function Descriptions.....	8	Ordering Guide .....	18
Typical Performance Characteristics .....	9		

## REVISION HISTORY

### 9/08—Rev. 0 to Rev. A

Added 16-Lead SOIC .....	Universal
Changes to General Description Section .....	1
Changes to Table 1, Test Conditions/Comments Column .....	3
Changes to Timing Specifications Table Summary .....	4
Changes to Table 4, Note 2 .....	5
Added Figure 6; Renumbered Sequentially .....	8
Changes to Terminology Section.....	12
Updated Outline Dimensions .....	18
Changes to Ordering Guide .....	18

### 5/08—Revision 0: Initial Version

## SPECIFICATIONS

$V_{DD1} = 4.5\text{ V to }5.5\text{ V}$ ,  $V_{DD2} = 3\text{ V to }5.5\text{ V}$ ,  $V_{IN+} = -200\text{ mV to }+200\text{ mV}$ , except where specified, and  $V_{IN-} = 0\text{ V}$  (single-ended);  $T_A = -40^\circ\text{C to }+125^\circ\text{C}$ , except where specified;  $f_{MCLK} = 10\text{ MHz}$ , tested with Sinc<sup>3</sup> filter, 256 decimation rate, as defined by Verilog code, unless otherwise noted.

**Table 1.**

Parameter	Y Version <sup>1</sup>			Unit	Test Conditions/Comments
	Min	Typ	Max		
<b>STATIC PERFORMANCE</b>					
Resolution	16			Bits	Filter output truncated to 16 bits
Integral Nonlinearity <sup>2</sup>		±2	±12	LSB	$V_{IN+} = \pm 200\text{ mV}$ , $T_A = -40^\circ\text{C to }+125^\circ\text{C}$
		±4	±16	LSB	$V_{IN+} = \pm 250\text{ mV}$ , $T_A = -40^\circ\text{C to }+85^\circ\text{C}$
		±4	±22	LSB	$V_{IN+} = \pm 250\text{ mV}$ , $T_A = -40^\circ\text{C to }+125^\circ\text{C}$
Differential Nonlinearity <sup>2</sup>			±0.9	LSB	Guaranteed no missing codes to 16 bits
Offset Error <sup>2</sup>		±50	±500	µV	
Offset Drift vs. Temperature		1.5	4	µV/°C	-40°C to +125°C
Offset Drift vs. $V_{DD1}$		120		µV/V	
Gain Error <sup>2</sup>			±1.5	mV	-40°C to +85°C
			±2	mV	-40°C to +125°C
Gain Error Drift vs. Temperature		23		µV/°C	-40°C to +125°C
Gain Error Drift vs. $V_{DD1}$		110		µV/V	
<b>ANALOG INPUT</b>					
Input Voltage Range	-250		+250	mV	For specified performance, full range = ±320 mV
Dynamic Input Current		±7	±8	µA	$V_{IN+} = 400\text{ mV}$ , $V_{IN-} = 0\text{ V}$
		±9	±10	µA	$V_{IN+} = 500\text{ mV}$ , $V_{IN-} = 0\text{ V}$
		±0.5		µA	$V_{IN+} = V_{IN-} = 0\text{ V}$
Input Capacitance		10		pF	
<b>DYNAMIC SPECIFICATIONS</b>					
Signal-to-Noise and Distortion (SINAD) Ratio <sup>2</sup>	70	78		dB	$V_{IN+} = 35\text{ Hz}$
	68	78		dB	$V_{IN+} = \pm 200\text{ mV}$
Signal-to-Noise Ratio (SNR)	73	80		dB	$V_{IN+} = \pm 250\text{ mV}$
	72	80		dB	$V_{IN+} = \pm 200\text{ mV}$
Total Harmonic Distortion (THD) <sup>2</sup>		-84		dB	$V_{IN+} = \pm 250\text{ mV}$
		-82		dB	$V_{IN+} = \pm 200\text{ mV}$
Peak Harmonic or Spurious Noise (SFDR) <sup>2</sup>		-86		dB	$V_{IN+} = \pm 250\text{ mV}$
		-84		dB	$V_{IN+} = \pm 200\text{ mV}$
Effective Number of Bits (ENOB) <sup>2</sup>	11.5	12.5		Bits	$V_{IN+} = \pm 200\text{ mV}$
	11	12.5		Bits	$V_{IN+} = \pm 250\text{ mV}$
Isolation Transient Immunity <sup>2</sup>	25	30		kV/µs	
<b>LOGIC OUTPUTS</b>					
Output High Voltage, $V_{OH}$	$V_{DD2} - 0.1$			V	$I_O = -200\text{ µA}$
Output Low Voltage, $V_{OL}$			0.4	V	$I_O = +200\text{ µA}$
<b>POWER REQUIREMENTS</b>					
$V_{DD1}$	4.5		5.5	V	
$V_{DD2}$	3		5.5	V	
$I_{DD1}$ <sup>3</sup>		11	13	mA	$V_{DD1} = 5.5\text{ V}$
$I_{DD2}$ <sup>4</sup>		4.5	6	mA	$V_{DD2} = 5.5\text{ V}$
		3	3.5	mA	$V_{DD2} = 3.3\text{ V}$

<sup>1</sup> All voltages are relative to their respective ground.

<sup>2</sup> See the Terminology section.

<sup>3</sup> See Figure 15.

<sup>4</sup> See Figure 16.

# AD7400A

## TIMING SPECIFICATIONS

$V_{DD1} = 4.5\text{ V to }5.5\text{ V}$ ,  $V_{DD2} = 3\text{ V to }5.5\text{ V}$ ,  $T_A = -40^\circ\text{C to }+125^\circ\text{C}$ , except where specified.<sup>1</sup>

Table 2.

Parameter	Limit at $t_{MIN}$ , $t_{MAX}$	Unit	Description
$f_{MCLKOUT}^2$	10	MHz typ	Master clock output frequency
	9/11	MHz min/MHz max	Master clock output frequency
$t_1^3$	40	ns max	Data access time after MCLK rising edge
$t_2^3$	10	ns min	Data hold time after MCLK rising edge
$t_3$	$0.4 \times t_{MCLKOUT}$	ns min	Master clock low time
$t_4$	$0.4 \times t_{MCLKOUT}$	ns min	Master clock high time

<sup>1</sup> Sample tested during initial release to ensure compliance.

<sup>2</sup> Mark space ratio for clock output is 40/60 to 60/40.

<sup>3</sup> Measured with the load circuit shown in Figure 2 and defined as the time required for the output to cross 0.8 V or 2.0 V.

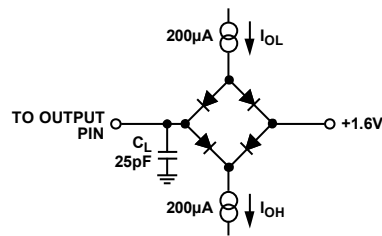

Figure 2. Load Circuit for Digital Output Timing Specifications

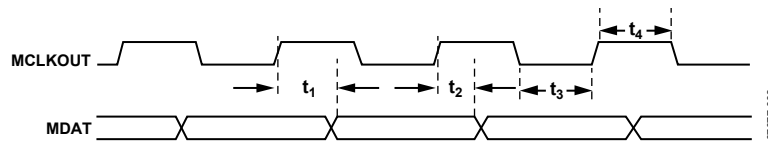

Figure 3. Data Timing

## INSULATION AND SAFETY-RELATED SPECIFICATIONS

Table 3.

Parameter	Symbol	Value	Unit	Conditions
Input-to-Output Momentary Withstand Voltage	V <sub>ISO</sub>	3750 min	V rms	1-minute duration
Minimum External Air Gap (Clearance)	L(I01)	7.46 min	mm	Measured from input terminals to output terminals, shortest distance through air
Minimum External Tracking (Creepage)	L(I02)	8.1 min	mm	Measured from input terminals to output terminals, shortest distance path along body
Minimum Internal Gap (Internal Clearance)		0.017 min	mm	Insulation distance through insulation
Tracking Resistance (Comparative Tracking Index)	CTI	>175	V	DIN IEC 112/VDE 0303 Part 1
Isolation Group		IIIa		Material group (DIN VDE 0110, 1/89, Table 1)

## REGULATORY INFORMATION

Table 4.

UL <sup>1</sup>	CSA	VDE <sup>2</sup>
Recognized Under 1577 Component Recognition Program <sup>1</sup>	Approved under CSA Component Acceptance Notice #5A	Certified according to DIN V VDE V 0884-10 (VDE V 0884-10):2006-12 <sup>2</sup>
3750 V rms isolation voltage	Reinforced insulation per CSA 60950-1-03 and IEC 60950-1, 630 V rms maximum working voltage	Reinforced insulation per DIN V VDE V 0884-10 (VDE V 0884-10):2006-12, 891 V peak
File E214100	File 205078	File 2471900-4880-0001

<sup>1</sup> In accordance with UL 1577, each AD7400A is proof tested by applying an insulation test voltage  $\geq 4500$  V rms for 1 sec (current leakage detection limit = 7.5  $\mu$ A).

<sup>2</sup> In accordance with DIN V VDE V 0884-10, each AD7400A is proof tested by applying an insulation test voltage  $\geq 1671$  V peak for 1 sec (partial discharge detection limit = 5 pC).

# AD7400A

## DIN V VDE V 0884-10 (VDE V 0884-10) INSULATION CHARACTERISTICS

This isolator is suitable for reinforced electrical isolation only within the safety limit data. Maintenance of the safety data is ensured by means of protective circuits.

Table 5.

Parameter	Symbol	Characteristic	Unit
INSTALLATION CLASSIFICATION PER DIN VDE 0110 For Rated Mains Voltage $\leq 300$ V rms For Rated Mains Voltage $\leq 450$ V rms For Rated Mains Voltage $\leq 600$ V rms		I to IV I to II I to II	
CLIMATIC CLASSIFICATION		40/105/21	
POLLUTION DEGREE (DIN VDE 0110, Table 1)		2	
MAXIMUM WORKING INSULATION VOLTAGE	$V_{IORM}$	891	V peak
INPUT-TO-OUTPUT TEST VOLTAGE, METHOD B1 $V_{IORM} \times 1.875 = V_{PR}$ , 100% Production Test, $t_m = 1$ sec, Partial Discharge $< 5$ pC	$V_{PR}$	1671	V peak
INPUT-TO-OUTPUT TEST VOLTAGE, METHOD A After Environmental Test Subgroup 1 $V_{IORM} \times 1.6 = V_{PR}$ , $t_m = 60$ sec, Partial Discharge $< 5$ pC After Input and/or Safety Test Subgroup 2/Safety Test Subgroup 3 $V_{IORM} \times 1.2 = V_{PR}$ , $t_m = 60$ sec, Partial Discharge $< 5$ pC	$V_{PR}$	1426 1069	V peak V peak
HIGHEST ALLOWABLE OVERVOLTAGE (TRANSIENT OVERVOLTAGE, $t_{TR} = 10$ sec)	$V_{TR}$	6000	V peak
SAFETY-LIMITING VALUES (MAXIMUM VALUE ALLOWED IN THE EVENT OF A FAILURE, ALSO SEE Figure 4) Case Temperature Side 1 Current Side 2 Current	$T_s$ $I_{S1}$ $I_{S2}$	150 265 335	$^{\circ}\text{C}$ mA mA
INSULATION RESISTANCE AT $T_s$ , $V_{IO} = 500$ V	$R_s$	$>10^9$	$\Omega$

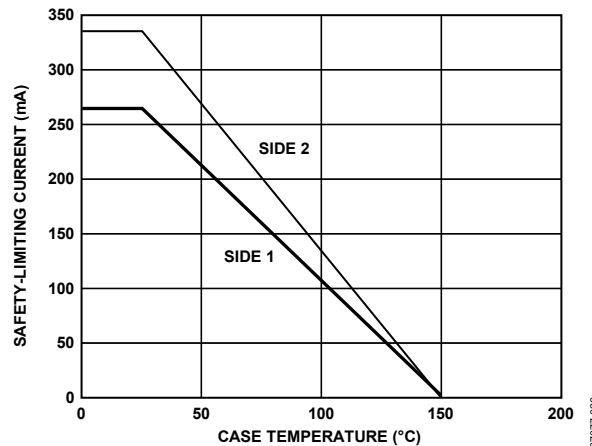

Figure 4. Thermal Derating Curve, Dependence of Safety-Limiting Values with Case Temperature per DIN V VDE V 0884-10

## ABSOLUTE MAXIMUM RATINGS

$T_A = 25^\circ\text{C}$ , unless otherwise noted. All voltages are relative to their respective ground.

**Table 6.**

Parameter	Rating
$V_{DD1}$ to $\text{GND}_1$	-0.3 V to +6.5 V
$V_{DD2}$ to $\text{GND}_2$	-0.3 V to +6.5 V
Analog Input Voltage to $\text{GND}_1$	-0.3 V to $V_{DD1} + 0.3$ V
Output Voltage to $\text{GND}_2$	-0.3 V to $V_{DD2} + 0.3$ V
Input Current to Any Pin Except Supplies <sup>1</sup>	$\pm 10$ mA
Operating Temperature Range	$-40^\circ\text{C}$ to $+125^\circ\text{C}$
Storage Temperature Range	$-65^\circ\text{C}$ to $+150^\circ\text{C}$
Junction Temperature	$150^\circ\text{C}$
PDIP Package	
$\theta_{JA}$ Thermal Impedance <sup>2</sup>	$116.8^\circ\text{C}/\text{W}$
$\theta_{JC}$ Thermal Impedance <sup>2</sup>	$38.9^\circ\text{C}/\text{W}$
SOIC Package	
$\theta_{JA}$ Thermal Impedance <sup>2</sup>	$89.2^\circ\text{C}/\text{W}$
$\theta_{JC}$ Thermal Impedance <sup>2</sup>	$55.6^\circ\text{C}/\text{W}$
Resistance (Input-to-Output), $R_{i-o}$	$10^{12} \Omega$
Capacitance (Input-to-Output), $C_{i-o}$ <sup>3</sup>	1.7 pF typ
RoHS-Compliant Temperature, Soldering	
Reflow	$260 (+0)^\circ\text{C}$
ESD	2.5 kV

<sup>1</sup> Transient currents of up to 100 mA do not cause SCR to latch-up.

<sup>2</sup> JEDEC 2S2P standard board.

<sup>3</sup>  $f = 1$  MHz.

Stresses above those listed under Absolute Maximum Ratings may cause permanent damage to the device. This is a stress rating only; functional operation of the device at these or any other conditions above those indicated in the operational section of this specification is not implied. Exposure to absolute maximum rating conditions for extended periods may affect device reliability.

**Table 7. Maximum Continuous Working Voltage<sup>1</sup>**

Parameter	Max	Unit	Constraint
AC Voltage, Bipolar Waveform	565	V peak	50-year minimum lifetime
AC Voltage, Unipolar Waveform	891	V peak	Maximum CSA/VDE approved working voltage
DC Voltage	891	V	Maximum CSA/VDE approved working voltage

<sup>1</sup> Refers to continuous voltage magnitude imposed across the isolation barrier. See the Insulation Lifetime section for more details.

### ESD CAUTION



**ESD (electrostatic discharge) sensitive device.** Charged devices and circuit boards can discharge without detection. Although this product features patented or proprietary protection circuitry, damage may occur on devices subjected to high energy ESD. Therefore, proper ESD precautions should be taken to avoid performance degradation or loss of functionality.

# AD7400A

## PIN CONFIGURATION AND FUNCTION DESCRIPTIONS

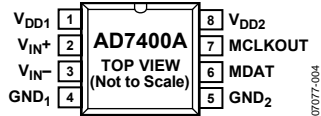

Figure 5. 8-Lead PDIP Pin Configuration

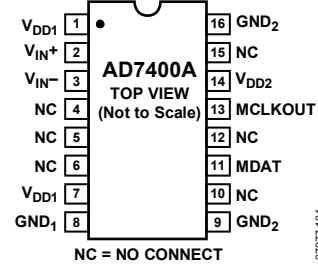

Figure 6. 16-Lead SOIC Pin Configuration

Table 8. Pin Function Descriptions

Pin No.		Mnemonic	Description
PDIP	SOIC		
1	1, 7	V <sub>DD1</sub>	Supply Voltage, 4.5 V to 5.5 V. This is the supply voltage for the isolated side of the AD7400A and is relative to GND <sub>1</sub> .
2	2	V <sub>IN+</sub>	Positive Analog Input. Specified range of ±250 mV.
3	3	V <sub>IN-</sub>	Negative Analog Input. Normally connected to GND <sub>1</sub> .
N/A	4 to 6, 10, 12, 15	NC	No Connect.
4	8	GND <sub>1</sub>	Ground 1. This is the ground reference point for all circuitry on the isolated side.
5	9, 16	GND <sub>2</sub>	Ground 2. This is the ground reference point for all circuitry on the nonisolated side.
6	11	MDAT	Serial Data Output. The single bit modulator output is supplied to this pin as a serial data stream. The bits are clocked out on the rising edge of the MCLKOUT output and are valid on the following MCLKOUT rising edge.
7	13	MCLKOUT	Master Clock Logic Output (10 MHz Typical). The bit stream from the modulator is valid on the rising edge of MCLKOUT.
8	14	V <sub>DD2</sub>	Supply Voltage, 3 V to 5.5 V. This is the supply voltage for the nonisolated side and is relative to GND <sub>2</sub> .



# TYPICAL PERFORMANCE CHARACTERISTICS

T<sub>A</sub> = 25°C, using 20 kHz brickwall filter, unless otherwise noted.

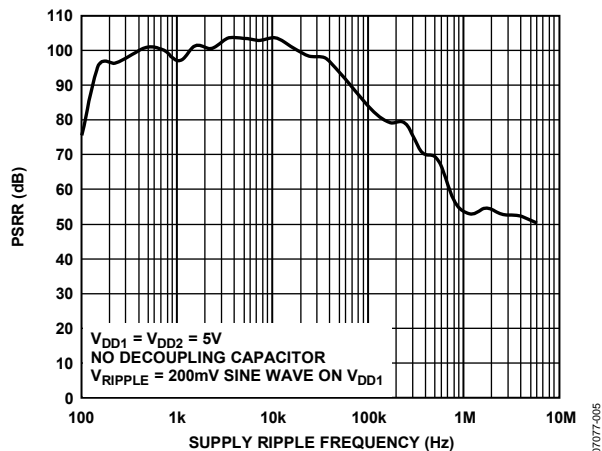

Figure 7. PSRR vs. Supply Ripple Frequency Without Supply Decoupling (1 MHz Filter Used)

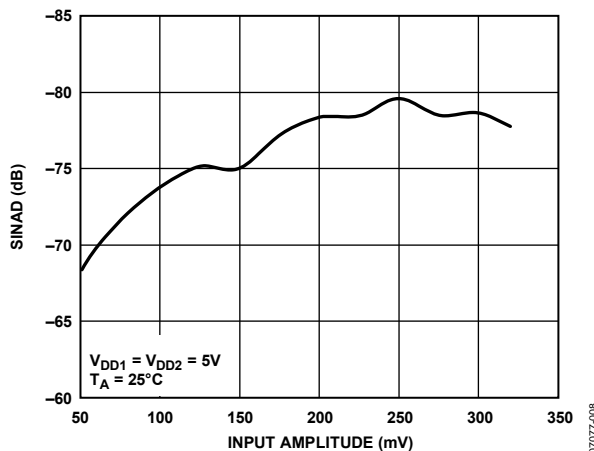

Figure 10. SINAD vs. V<sub>IN</sub>

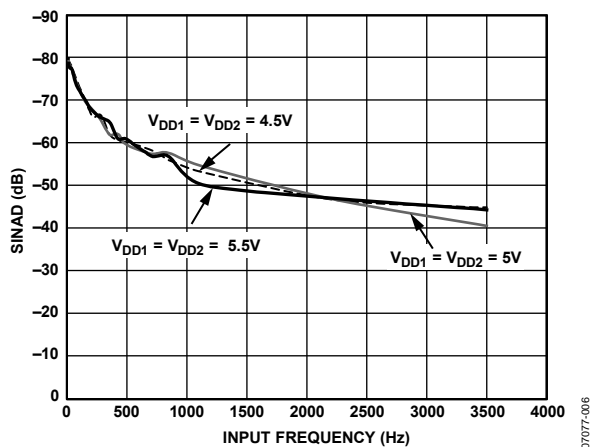

Figure 8. SINAD vs. Analog Input Frequency for Various Supply Voltages

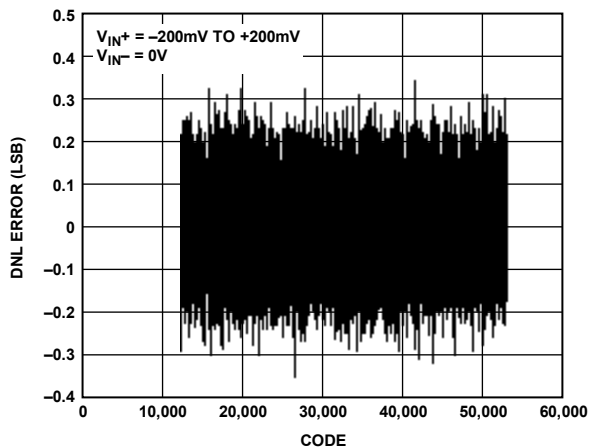

Figure 11. Typical DNL, ±200 mV Range (Using Sinc<sup>3</sup> Filter, 256 Decimation Rate)

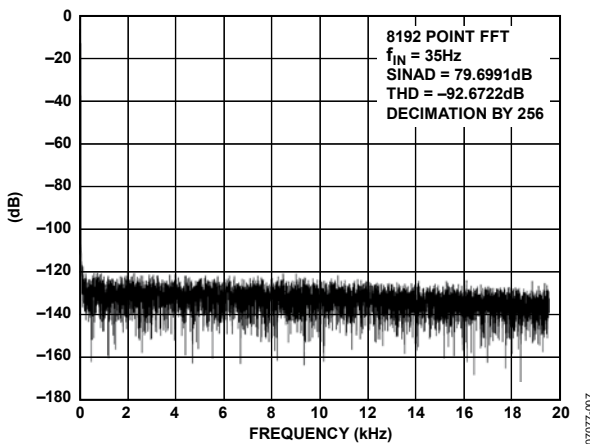

Figure 9. Typical FFT, ±200 mV Range (Using Sinc<sup>3</sup> Filter, 256 Decimation Rate)

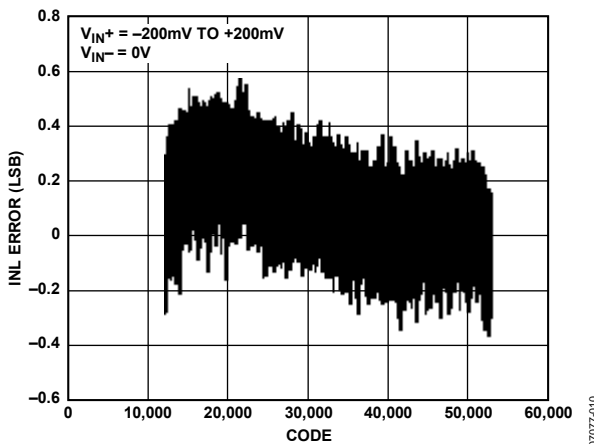

Figure 12. Typical INL, ±200 mV Range (Using Sinc<sup>3</sup> Filter, 256 Decimation Rate)

# AD7400A

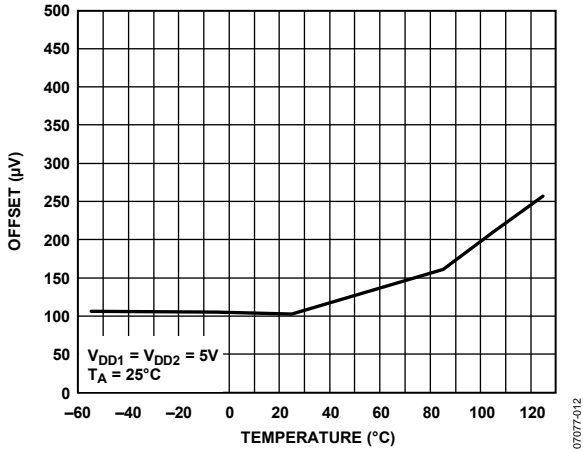

Figure 13. Offset Drift vs. Temperature

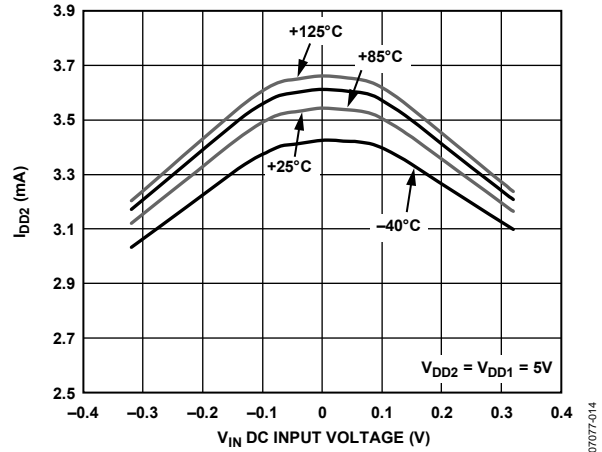

Figure 16.  $I_{DD2}$  vs.  $V_{IN}$  at Various Temperatures

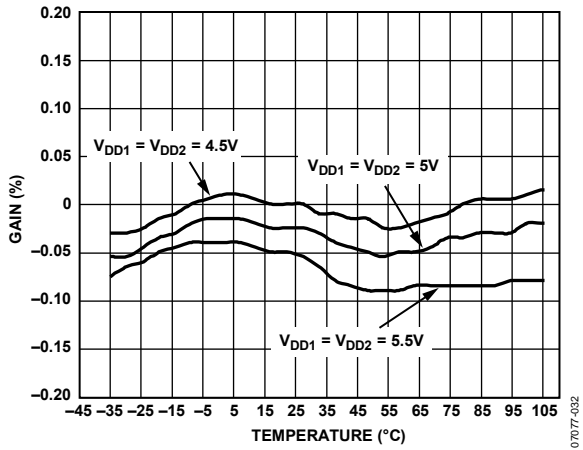

Figure 14. Gain Error Drift vs. Temperature for Various Supply Voltages

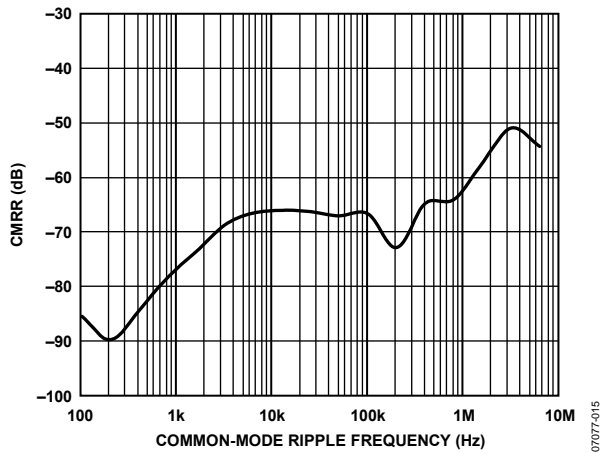

Figure 17. CMRR vs. Common-Mode Ripple Frequency

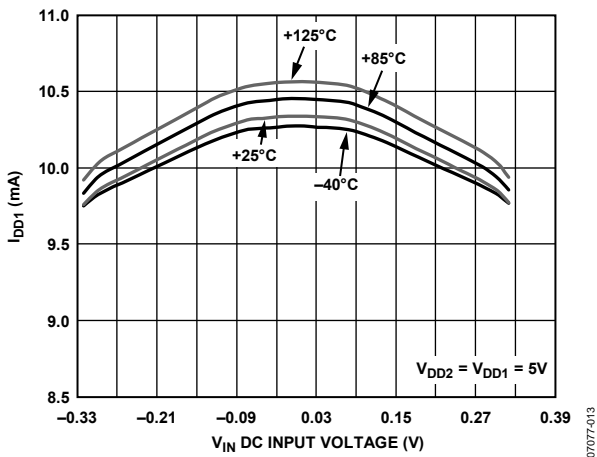

Figure 15.  $I_{DD1}$  vs.  $V_{IN}$  at Various Temperatures

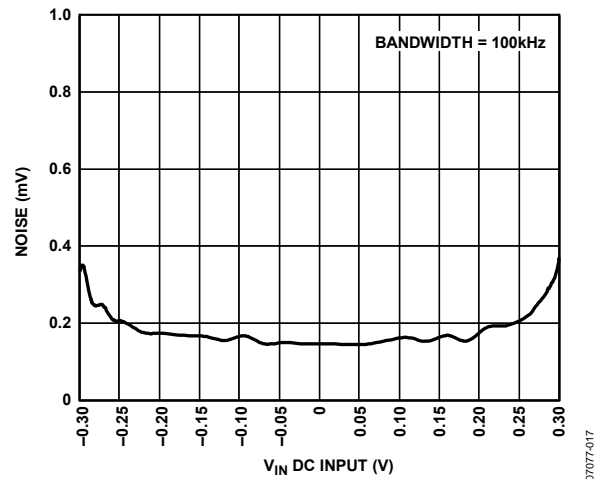

Figure 18. RMS Noise Voltage vs.  $V_{IN}$  DC Input

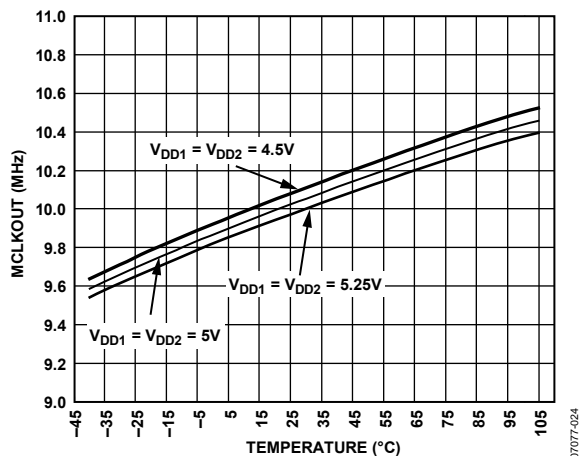

Figure 19. MCLKOUT vs. Temperature for Various Supplies

## TERMINOLOGY

### Differential Nonlinearity

Differential nonlinearity is the difference between the measured and the ideal 1 LSB change between any two adjacent codes in the ADC.

### Integral Nonlinearity

Integral nonlinearity is the maximum deviation from a straight line passing through the endpoints of the ADC transfer function. The endpoints of the transfer function are specified negative full scale,  $-250\text{ mV}$  ( $V_{\text{IN}+} - V_{\text{IN}-}$ ), Code 7169, and specified positive full scale,  $+250\text{ mV}$  ( $V_{\text{IN}+} - V_{\text{IN}-}$ ), Code 58,366 for the 16-bit level.

### Offset Error

Offset is the deviation of the midscale code (Code 32,768 for the 16-bit level) from the ideal  $V_{\text{IN}+} - V_{\text{IN}-}$  (that is, 0 V).

### Gain Error

Gain error includes both positive full-scale gain error and negative full-scale gain error. Positive full-scale gain error is the deviation of the specified positive full-scale code (58,366 for the 16-bit level) from the ideal  $V_{\text{IN}+} - V_{\text{IN}-}$  ( $+250\text{ mV}$ ) after the offset error is adjusted out. Negative full-scale gain error is the deviation of the specified negative full-scale code (7169 for the 16-bit level) from the ideal  $V_{\text{IN}+} - V_{\text{IN}-}$  ( $-250\text{ mV}$ ) after the offset error is adjusted out. Gain error includes reference error.

### Signal-to-Noise and Distortion (SINAD) Ratio

This ratio is the measured ratio of signal-to-noise and distortion at the output of the ADC. The signal is the rms amplitude of the fundamental. Noise is the sum of all nonfundamental signals up to half the sampling frequency ( $f_s/2$ ), excluding dc. The ratio is dependent on the number of quantization levels in the digitization process; the more levels, the smaller the quantization noise. The theoretical signal-to-noise and distortion ratio for an ideal N-bit converter with a sine wave input is given by

$$\text{Signal-to-Noise and Distortion} = (6.02N + 1.76)\text{ dB}$$

Therefore, for a 12-bit converter, SINAD is 74 dB.

### Effective Number of Bits (ENOB)

The ENOB is defined by

$$\text{ENOB} = (\text{SINAD} - 1.76)/6.02$$

### Total Harmonic Distortion (THD)

THD is the ratio of the rms sum of harmonics to the fundamental. For the AD7400A, it is defined as

$$\text{THD(dB)} = 20 \log \frac{\sqrt{V_2^2 + V_3^2 + V_4^2 + V_5^2 + V_6^2}}{V_1}$$

where:

$V_1$  is the rms amplitude of the fundamental.

$V_2$ ,  $V_3$ ,  $V_4$ ,  $V_5$ , and  $V_6$  are the rms amplitudes of the second through the sixth harmonics.

### Peak Harmonic or Spurious Noise

Peak harmonic or spurious noise is defined as the ratio of the rms value of the next largest component in the ADC output spectrum (up to  $f_s/2$ , excluding dc) to the rms value of the fundamental. Normally, the value of this specification is determined by the largest harmonic in the spectrum, but for ADCs where the harmonics are buried in the noise floor, it is a noise peak.

### Common-Mode Rejection Ratio (CMRR)

CMRR is defined as the ratio of the power in the ADC output at  $\pm 250\text{ mV}$  frequency,  $f$ , to the power of a  $250\text{ mV}$  p-p sine wave applied to the common-mode voltage of  $V_{\text{IN}+}$  and  $V_{\text{IN}-}$  of frequency  $f_s$  as

$$\text{CMRR (dB)} = 10 \log(P_f/P_{f_s})$$

where:

$P_f$  is the power at frequency  $f$  in the ADC output.

$P_{f_s}$  is the power at frequency  $f_s$  in the ADC output.

### Power Supply Rejection Ratio (PSRR)

Variations in power supply affect the full-scale transition but not the converter linearity. PSRR is the maximum change in the specified full-scale ( $\pm 250\text{ mV}$ ) transition point due to a change in power supply voltage from the nominal value (see Figure 7).

### Isolation Transient Immunity

The isolation transient immunity specifies the rate of rise/fall of a transient pulse applied across the isolation boundary beyond which clock or data is corrupted. (The AD7400A was tested using a transient pulse frequency of 100 kHz.)

# THEORY OF OPERATION

## CIRCUIT INFORMATION

The AD7400A isolated  $\Sigma$ - $\Delta$  modulator converts an analog input signal into a high speed (10 MHz typical), single-bit data stream; the time average of the single-bit data from the modulator is directly proportional to the input signal. Figure 22 shows a typical application circuit where the AD7400A is used to provide isolation between the analog input, a current sensing resistor, and the digital output, which is then processed by a digital filter to provide an N-bit word.

## ANALOG INPUT

The differential analog input of the AD7400A is implemented with a switched capacitor circuit. This circuit implements a second-order modulator stage that digitizes the input signal into a 1-bit output stream. The sample clock (MCLKOUT) provides the clock signal for the conversion process as well as the output data-framing clock. This clock source is internal on the AD7400A. The analog input signal is continuously sampled by the modulator and compared to an internal voltage reference. A digital stream that accurately represents the analog input over time appears at the output of the converter (see Figure 20).

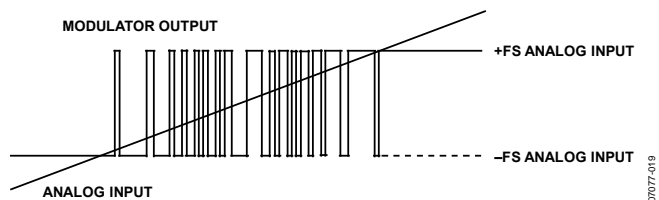

Figure 20. Analog Input vs. Modulator Output

A differential signal of 0 V ideally results in a stream of 1s and 0s at the MDAT output pin. This output is high 50% of the time and low 50% of the time. A differential input of 200 mV produces a stream of 1s and 0s that are high 81.25% of the time (for a +250 mV input, the output stream is high 89.06% of the time). A differential input of -200 mV produces a stream of 1s and 0s that are high 18.75% of the time (for a -250 mV input, the output stream is high 10.94% of the time).

A differential input of 320 mV ideally results in a stream of all 1s. This is the absolute full-scale range of the AD7400A, while 250 mV is the specified full-scale range, as shown in Table 9.

Table 9. Analog Input Range

Analog Input	Voltage Input
Full-Scale Range	+640 mV
Positive Full Scale	+320 mV
Positive Typical Input Range	+250 mV
Positive Specified Input Range	+200 mV
Zero	0 mV
Negative Specified Input Range	-200 mV
Negative Typical Input Range	-250 mV
Negative Full Scale	-320 mV

To reconstruct the original information, this output needs to be digitally filtered and decimated. A Sinc<sup>3</sup> filter is recommended because this is one order higher than that of the AD7400A modulator. If a 256 decimation rate is used, the resulting 16-bit word rate is 39 kHz, assuming a 10 MHz internal clock frequency. Figure 21 shows the transfer function of the AD7400A relative to the 16-bit output.

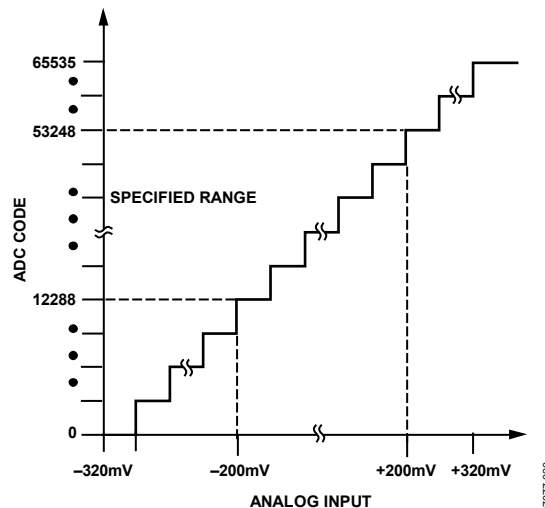

Figure 21. Filtered and Decimated 16-Bit Transfer Characteristic

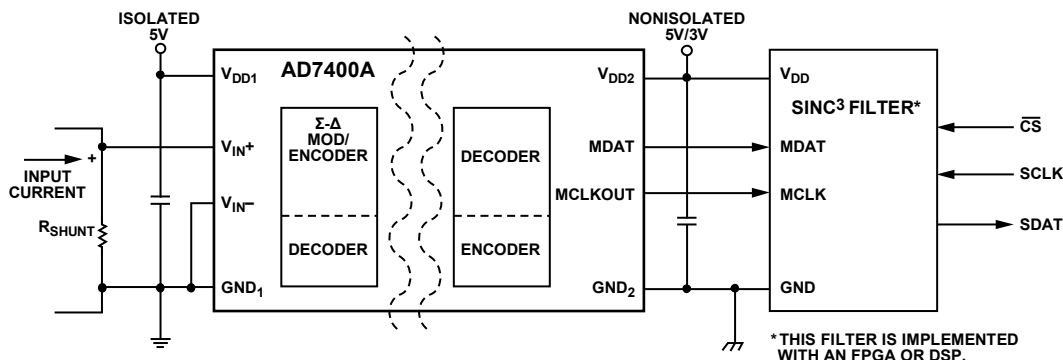

Figure 22. Typical Application Circuit

## DIFFERENTIAL INPUTS

The analog input to the modulator is a switched capacitor design. The analog signal is converted into charge by highly linear sampling capacitors. A simplified equivalent circuit diagram of the analog input is shown in Figure 23. A signal source driving the analog input must be able to provide the charge onto the sampling capacitors every half MCLKOUT cycle and settle to the required accuracy within the next half cycle.

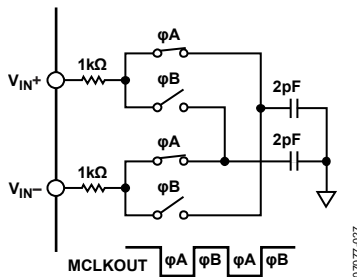

Figure 23. Analog Input Equivalent Circuit

Because the AD7400A samples the differential voltage across its analog inputs, low noise performance is attained with an input circuit that provides low common-mode noise at each input. The amplifiers used to drive the analog inputs play a critical role in attaining the high performance available from the AD7400A.

When a capacitive load is switched onto the output of an op amp, the amplitude drops momentarily. The op amp tries to correct the situation and, in the process, hits its slew rate limit. This nonlinear response, which can cause excessive ringing, can lead to distortion. To remedy the situation, a low-pass RC filter can be connected between the amplifier and the input to the AD7400A. The external capacitor at each input aids in supplying the current spikes created during the sampling process, and the resistor isolates the op amp from the transient nature of the load.

The recommended circuit configuration for driving the differential inputs to achieve best performance is shown in Figure 24. A capacitor between the two input pins sources or sinks charge to allow most of the charge that is needed by one input to be effectively supplied by the other input. The series resistor again isolates any op amp from the current spikes created during the sampling process. Recommended values for the resistors and capacitor are 22 Ω and 47 pF, respectively.

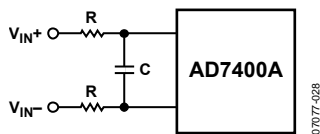

Figure 24. Differential Input RC Network

## CURRENT SENSING APPLICATIONS

The AD7400A is ideally suited for current sensing applications where the voltage across a shunt resistor is monitored. The load current flowing through an external shunt resistor produces a voltage at the input terminals of the AD7400A. The AD7400A provides isolation between the analog input from the current sensing resistor and the digital outputs. By selecting the appropriate shunt resistor value, a variety of current ranges can be monitored.

### Choosing $R_{SENSE}$

The shunt resistor values used in conjunction with the AD7400A are determined by the specific application requirements in terms of voltage, current, and power. Small resistors minimize power dissipation, while low inductance resistors prevent any induced voltage spikes, and good tolerance devices reduce current variations. The final values chosen are a compromise between low power dissipation and good accuracy. Low value resistors have less power dissipated in them, but higher value resistors may be required to use the full input range of the ADC, thus achieving maximum SNR performance.

When the peak sense current is known, the voltage range of the AD7400A ( $\pm 200$  mV) is divided by the maximum sense current to yield a suitable shunt value. If the power dissipation in the shunt resistor is too large, the shunt resistor can be reduced, in which case, less of the ADC input range is used. Using less of the ADC input range results in performance that is more susceptible to noise and offset errors because offset errors are fixed and are thus more significant when smaller input ranges are used.

$R_{SENSE}$  must be able to dissipate the  $I^2R$  power losses. If the power dissipation rating of the resistor is exceeded, its value may drift or the resistor may be damaged, resulting in an open circuit. This can result in a differential voltage across the terminals of the AD400A in excess of the absolute maximum ratings (see Table 6.). If  $I_{SENSE}$  has a large high frequency component, take care to choose a resistor with low inductance.

## VOLTAGE SENSING APPLICATIONS

The AD7400A can also be used for isolated voltage monitoring. For example, in motor control applications, it can be used to sense bus voltage. In applications where the voltage being monitored exceeds the specified analog input range of the AD7400A, a voltage divider network can be used to reduce the voltage being monitored to the required range.

## DIGITAL FILTER

The overall system resolution and throughput rate is determined by the filter selected and the decimation rate used. The higher the decimation rate, the greater the system accuracy, as illustrated in Figure 25. However, there is a tradeoff between accuracy and throughput rate and, therefore, higher decimation rates result in lower throughput solutions.

A Sinc<sup>3</sup> filter is recommended for use with the AD7400A. This filter can be implemented on an FPGA or a DSP.

$$H(z) = \left( \frac{1 - Z^{DR}}{1 - Z^{-1}} \right)^3$$

where DR is the decimation rate.

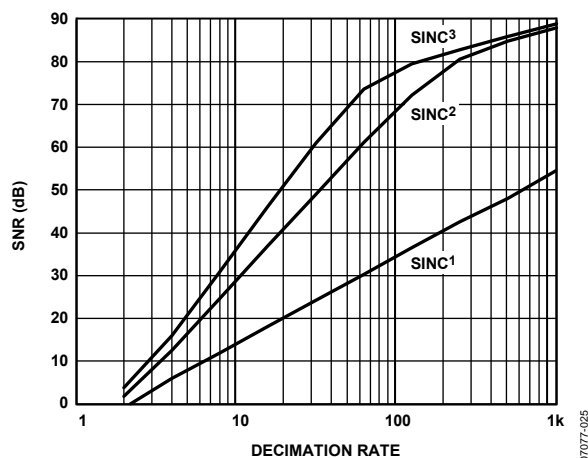

Figure 25. SNR vs. Decimation Rate for Different Filter Types

The following Verilog code provides an example of a Sinc<sup>3</sup> filter implementation on a Xilinx® Spartan-II 2.5 V FPGA. This code can possibly be compiled for another FPGA, such as an Altera® device. Note that the data is read on the negative clock edge in this case, although it can be read on the positive edge, if preferred. Figure 25 shows the effect of using different decimation rates with various filter types.

```

/*`Data is read on negative clk edge*/
module DEC256SINC24B(mdata1, mclk1, reset,
DATA);
input mclk1; /*used to clk filter*/
input reset; /*used to reset filter*/
input mdata1; /*ip data to be
filtered*/
output [15:0] DATA; /*filtered op*/
integer location;
integer info_file;
reg [23:0] ip_data1;
reg [23:0] acc1;
reg [23:0] acc2;
reg [23:0] acc3;
reg [23:0] acc3_d1;
reg [23:0] acc3_d2;
reg [23:0] diff1;

```

```

reg [23:0] diff2;
reg [23:0] diff3;
reg [23:0] diff1_d;
reg [23:0] diff2_d;
reg [15:0] DATA;
reg [7:0] word_count;
reg word_clk;
reg init;

/*Perform the Sinc ACTION*/
always @ (mdata1)
if(mdata1==0)
ip_data1 <= 0; /* change from a 0
to a -1 for 2's comp */
else
ip_data1 <= 1;

/*ACCUMULATOR (INTEGRATOR)
Perform the accumulation (IIR) at the speed
of the modulator.
MCLKOUT
IP_DATA1
ACC1+
ACC2+
ACC3+
Figure 26. Accumulator
Z = one sample delay
MCLKOUT = modulators conversion bit rate
*/
always @ (negedge mclk1 or posedge reset)
if (reset)
begin
/*initialize acc registers on reset*/
acc1 <= 0;
acc2 <= 0;
acc3 <= 0;
end
else
begin
/*perform accumulation process*/
acc1 <= acc1 + ip_data1;
acc2 <= acc2 + acc1;
acc3 <= acc3 + acc2;
end

/*DECIMATION STAGE (MCLKOUT/ WORD_CLK)
*/
always @ (posedge mclk1 or posedge reset)
if (reset)
word_count <= 0;
else
word_count <= word_count + 1;
always @ (word_count)
word_clk <= word_count[7];

```

# AD7400A

```

/*DIFFERENTIATOR (including decimation
stage)
Perform the differentiation stage (FIR) at a
lower speed.

```

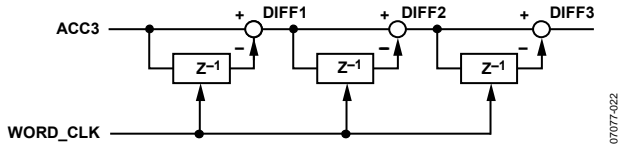

Figure 27. Differentiator

```

Z = one sample delay
WORD_CLK = output word rate
*/

```

```

always @ (posedge word_clk or posedge reset)
if(reset)
begin
acc3_d2 <= 0;
diff1_d <= 0;
diff2_d <= 0;
diff1 <= 0;
diff2 <= 0;
diff3 <= 0;
end
else
begin
diff1 <= acc3 - acc3_d2;
diff2 <= diff1 - diff1_d;
diff3 <= diff2 - diff2_d;
acc3_d2 <= acc3;
diff1_d <= diff1;

```

```

diff2_d <= diff2;
end
/* Clock the Sinc output into an output
register

```

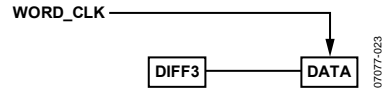

Figure 28. Clocking Sinc Output into an Output Register

```

WORD_CLK = output word rate
*/
always @ (posedge word_clk)
begin
DATA[15] <= diff3[23];
DATA[14] <= diff3[22];
DATA[13] <= diff3[21];
DATA[12] <= diff3[20];
DATA[11] <= diff3[19];
DATA[10] <= diff3[18];
DATA[9] <= diff3[17];
DATA[8] <= diff3[16];
DATA[7] <= diff3[15];
DATA[6] <= diff3[14];
DATA[5] <= diff3[13];
DATA[4] <= diff3[12];
DATA[3] <= diff3[11];
DATA[2] <= diff3[10];
DATA[1] <= diff3[9];
DATA[0] <= diff3[8];
end
endmodule

```



## APPLICATIONS INFORMATION

### GROUNDING AND LAYOUT

Supply decoupling with a value of 100 nF is strongly recommended on both  $V_{DD1}$  and  $V_{DD2}$ . Decoupling on one or both  $V_{DDx}$  pins does not significantly affect performance. In applications involving high common-mode transients, ensure that board coupling across the isolation barrier is minimized. Furthermore, the board layout should be designed so that any coupling that occurs equally affects all pins on a given component side. Failure to ensure this may cause voltage differentials between pins to exceed the absolute maximum ratings of the device, thereby leading to latch-up or permanent damage. Any decoupling used should be placed as close to the supply pins as possible.

Series resistance in the analog inputs should be minimized to avoid any distortion effects, especially at high temperatures. If possible, equalize the source impedance on each analog input to minimize offset. Beware of mismatch and thermocouple effects on the analog input PCB tracks to reduce offset drift.

### EVALUATING THE AD7400A PERFORMANCE

An AD7400A evaluation board is available with split ground planes and a board split beneath the AD7400A package to ensure isolation. This board allows access to each pin on the device for evaluation purposes.

The evaluation board package includes a fully assembled and tested evaluation board, documentation, and software for controlling the board from the PC via the EVAL-CED1Z. The software also includes a SINC<sup>3</sup> filter implemented on an FPGA. The evaluation board is used in conjunction with the EVAL-CED1Z board and can be used as a standalone board. The software allows the user to perform ac (fast Fourier transform) and dc (histogram of codes) tests on the AD7400A. The software and documentation are on a CD that ships with the evaluation board.

### INSULATION LIFETIME

All insulation structures subjected to sufficient time and/or voltage are vulnerable to breakdown. In addition to the testing performed by the regulatory agencies, Analog Devices has carried out an extensive set of evaluations to determine the lifetime of the insulation structure within the AD7400A.

These tests subjected populations of devices to continuous cross-isolation voltages. To accelerate the occurrence of failures, the selected test voltages were values exceeding those of normal use. The time to failure values of these units were recorded and used to calculate acceleration factors. These factors were then used to calculate the time to failure under normal operating conditions. The values shown in Table 7 are the lesser of the following two values:

- The value that ensures at least a 50-year lifetime of continuous use.
- The maximum CSA/VDE approved working voltage.

Note that the lifetime of the AD7400A varies according to the waveform type imposed across the isolation barrier. The *iCoupler* insulation structure is stressed differently depending on whether the waveform is bipolar ac, unipolar ac, or dc. Figure 29, Figure 30, and Figure 31 illustrate the different isolation voltage waveforms.

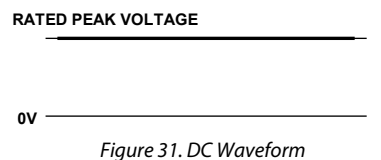
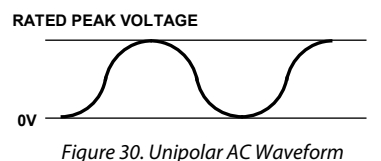
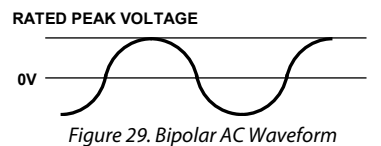

## OUTLINE DIMENSIONS

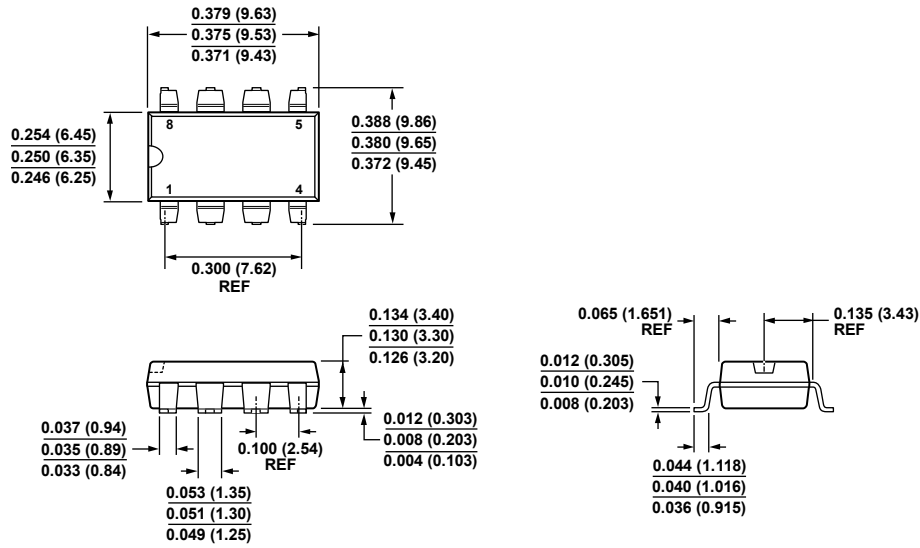

NOTE THAT THIS IS A PDIP CONVERTED TO SMD.  
CONTROLLING DIMENSIONS ARE IN INCHES; MILLIMETER DIMENSIONS (IN PARENTHESES) ARE ROUNDED-OFF INCHES EQUIVALENTS FOR REFERENCE ONLY AND ARE NOT APPROPRIATE FOR USE IN DESIGN.

Figure 32. 8-Lead DIP Style Surface Mount Package, With Gull Wing Leads [PDIP\_SMD] (NS-8)

Dimensions shown in inches and (millimeters)

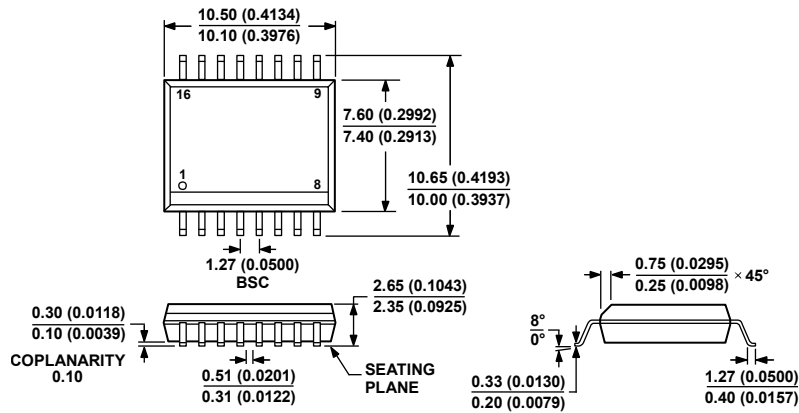

COMPLIANT TO JEDEC STANDARDS MS-013-AA  
CONTROLLING DIMENSIONS ARE IN MILLIMETERS; INCH DIMENSIONS (IN PARENTHESES) ARE ROUNDED-OFF MILLIMETER EQUIVALENTS FOR REFERENCE ONLY AND ARE NOT APPROPRIATE FOR USE IN DESIGN.

Figure 33. 16-Lead Standard Small Outline Package [SOIC\_W] Wide Body (RW-16)

Dimensions shown in millimeters and (inches)

## ORDERING GUIDE

Model	Temperature Range	Package Description	Package Option
AD7400AYNSZ <sup>1</sup>	-40°C to +125°C	8-Lead DIP Style Surface Mount Package, With Gull Wing Leads (PDIP_SMD)	NS-8
AD7400AYRWZ <sup>1</sup>	-40°C to +125°C	16-Lead Standard Small Outline Package (SOIC_W)	RW-16
AD7400AYRWZ-RL <sup>1</sup>	-40°C to +125°C	16-Lead Standard Small Outline Package (SOIC_W)	RW-16
EVAL-AD7400AEDZ <sup>1</sup>		Standalone Evaluation Board	
EVAL-CED1Z <sup>1</sup>		Development Board	

<sup>1</sup> Z = RoHS Compliant Part.

**NOTES**

**AD7400A**

**NOTES**