

### Data Sheet



#### Description

The ACPL-W454/P454 is similar to Avago Technologies other high speed transistor output optocouplers, but with shorter propagation delays and higher CTR. The ACPL-W454/P454 also has a guaranteed propagation delay difference ( $t_{PLH} - t_{PHL}$ ). These features make the ACPL-W454/P454 an excellent solution to IPM inverter dead time and other switching problems.

The ACPL-W454/P454 CTR, propagation delays, and CMR are specified both for TTL load and drive conditions and for IPM (Intelligent Power Module) load and drive conditions. Specifications and typical performance plots for both TTL and IPM conditions are provided for ease of application.

This diode-transistor optocoupler uses an insulating layer between the light emitting diode and an integrated photo detector to provide electrical insulation between input and output. Separate connections for the photodiode bias and output transistor collector increase the speed up to a hundred times over that of a conventional phototransistor coupler by reducing the base-collector capacitance.

#### Functional Diagram

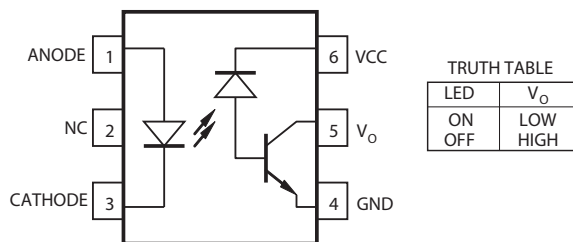

A 0.1  $\mu$ F bypass capacitor between pins 4 and 6 is recommended.

#### Schematic

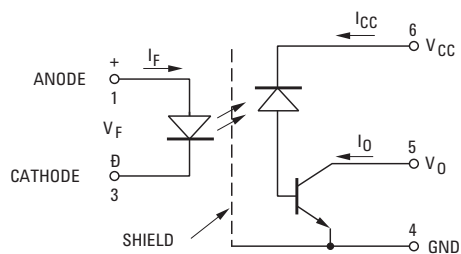

#### Features

- Package Clearance/Creepage at 8mm (ACPL-W454)
- Function Compatible with HCPL-4504
- Surface Mountable in 6-pin stretched SO6
- Short Propagation Delays for TTL and IPM Applications
- Very High Common Mode Transient Immunity: Guaranteed 15 kV/ $\mu$ s at  $V_{CM} = 1500$  V
- High CTR: >25% at 25°C
- Guaranteed Specifications for Common IPM Applications
- TTL Compatible
- Guaranteed AC and DC Performance Over Temperature: 0°C to 70°C
- Open Collector Output

#### Applications

- Inverter Circuits and Intelligent Power Module (IPM) Interfacing – Shorter propagation delays and guaranteed ( $t_{PLH} - t_{PHL}$ ) specifications.
- High Speed Logic Ground Isolation  
- TTL/TTL, TTL/LTTL, TTL/CMOS, TTL/LSTTL
- Line Receivers  
- High common mode transient immunity (>15 kV/ $\mu$ s for a TTL load/drive) and low input-output capacitance (0.6 pF).
- Replace Pulse Transformers  
- Save board space and weight
- Analog Signal Ground Isolation  
- Integrated photo detector provides improved linearity over phototransistors

**CAUTION:** It is advised that normal static precautions be taken in handling and assembly of this component to prevent damage and/or degradation which may be induced by ESD.

## Ordering Information

ACPL-P454 and ACPL-W454 are UL Recognized with 3750 Vrms for 1 minute per UL1577 and are approved under CSA Component Acceptance Notice #5, File CA 88324.

Part number	Option		Surface Mount	Tape & Reel	UL 5000 Vrms/ 1 Minute rating	IEC/EN/DIN EN 60747-5-2	Quantity	
	RoHS Compliant	Package						
ACPL-P454 ACPL-W454	-000E	Stretched SO-6	X				100 per tube	
	-500E		X	X			1000 per reel	
	-020E		X		X		100 per tube	
	-520E		X	X	X		1000 per reel	
	-060E		X				X	100 per tube
	-560E		X	X			X	1000 per reel

To order, choose a part number from the part number column and combine with the desired option from the option column to form an order entry. Combination of Option 020 and Option 060 is not available.

Example 1:

ACPL-P454-560E to order product of Stretched SO-6 package in Tape and Reel packaging with IEC/EN/DIN EN 60747-5-2 Safety Approval in RoHS compliant.

Example 2:

ACPL-P454-000E to order product of Stretched SO-6 package in tube packaging and RoHS compliant.

Option datasheets are available. Contact your Avago sales representative or authorized distributor for information.

## Package Outline Drawings

### ACPL-W454 (Stretched SO6, 8mm Clearance)

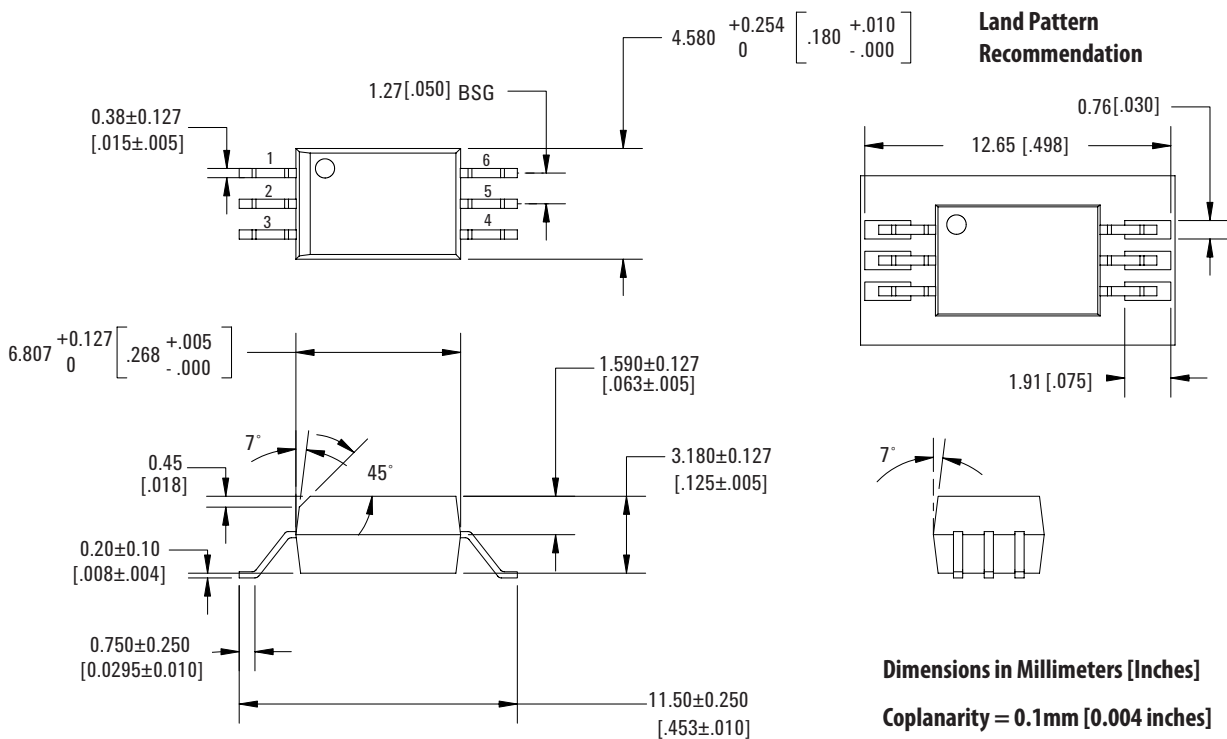

# ACPL-P454 (Stretched S06, 7mm Clearance)

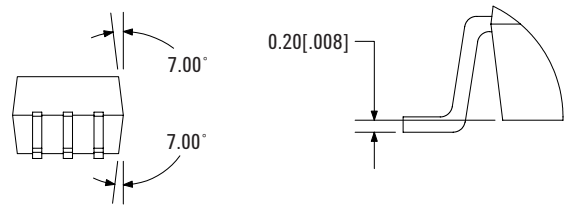
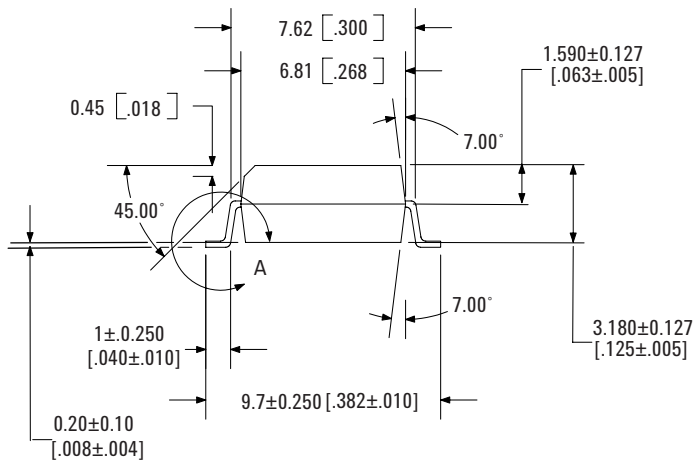
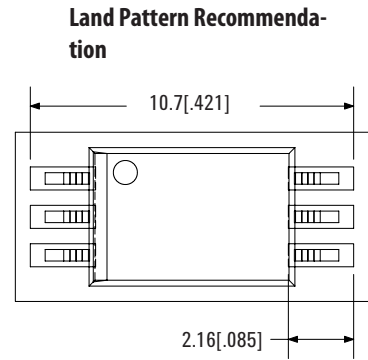
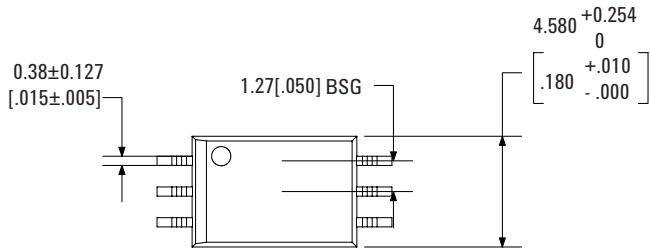

**Dimensions in Millimeters [Inches]**  
**Coplanarity = 0.1mm [0.004 inches]**

## Recommended Solder Reflow Thermal Profile

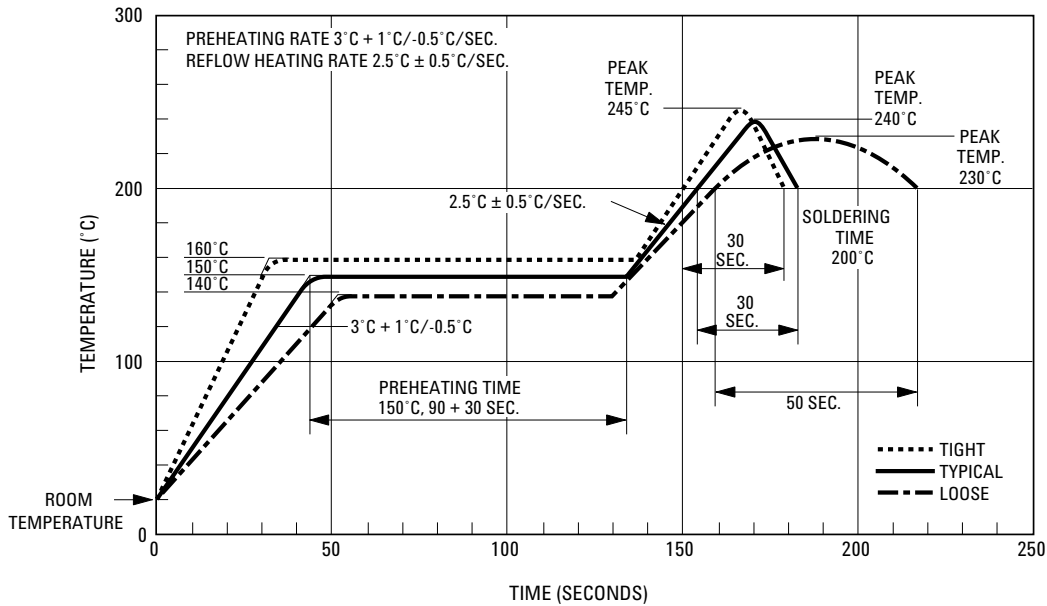

Note: Non-halide flux should be used

## Recommended Pb-Free IR Profile

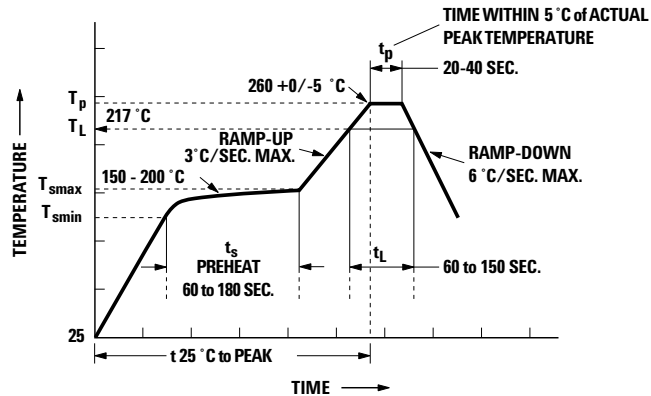

NOTES:  
 THE TIME FROM 25°C TO PEAK TEMPERATURE = 8 MINUTES MAX.  
 $T_{smax} = 200^{\circ}\text{C}, T_{smin} = 150^{\circ}\text{C}$

Note: Non-halide flux should be used

## Regulatory Information

The ACPL-W454/P454 are pending approval by the following organizations:

### IEC/EN/DIN EN 60747-5-2 (Option 060 only)

Approval under:

IEC 60747-5-2 :1997 + A1:2002

EN 60747-5-2:2001 + A1:2002

DIN EN 60747-5-2 (VDE 0884 Teil 2):2003-01

**UL** - Approval under UL 1577, component recognition program up to  $V_{ISO} = 3750 V_{RMS}$ . File E55361.

**CSA** - Approval under CSA Component Acceptance Notice #5, File CA 88324.

## Insulation Related Specifications

Parameter	Symbol	W454	P454	Units	Conditions
		Value	Value		
Min External Air Gap (Clearance)	L(IO1)	8	7	mm	Measured from input terminals to output terminals
Min. External Tracking Path (Creepage)	L(IO2)	8	8	mm	Measured from input terminals to output terminals
Min. Internal Plastic Gap (Clearance)		0.08	0.08	mm	Through insulation distance conductor to conductor
Tracking Resistance	CTI	175	175	V	DIN IEC 112/VDE 0303 Part 1
Isolation Group (per DIN VDE 0109)		IIIa			Material Group DIN VDE 0109

## IEC/EN/DIN EN 60747-5-2 Insulation Related Characteristics (Option 060 only)

Description	Symbol	Characteristic	Units
Installation classification per DIN VDE 0110/1.89, Table 1 for rated mains voltage $\leq 300$ V rms for rated mains voltage $\leq 450$ V rms		I-IV I-III	
Climatic Classification		55/100/21	
Pollution Degree (DIN VDE 0110/1.89)		2	
Maximum Working Insulation Voltage	$V_{IORM}$	630	$V_{peak}$
Input to Output Test Voltage, Method b* $V_{IORM} \times 1.875 = V_{PR}$ , 100% Production Test with $t_m = 1$ sec Partial Discharge $< 5$ pC,	$V_{PR}$	1181	$V_{peak}$
Input to Output Test Voltage, Method a* $V_{IORM} \times 1.5 = V_{PR}$ , Type and sample test, $t_m = 60$ sec, Partial Discharge $< 5$ pC	$V_{PR}$	945	$V_{peak}$
Highest Allowable Overvoltage* (Transient Overvoltage, $t_{ini} = 10$ sec)	$V_{IOTM}$	6000	$V_{peak}$
Safety Limiting Values	$T_S$	175	$^{\circ}C$
Case Temperature Input Current	$I_{S,INPUT}$	230	mA
Output Power	$P_{S,OUTPUT}$	600	mW
Insulation Resistance at $T_S$ , $V_{IO} = 500$ V	$R_S$	$\leq 10^9$	$\Omega$

\* Refer to the optocoupler section of the Designer's Catalog, under regulatory information (IEC/EN/DIN EN 60747-5-2) for a detailed description of Method a and Method b partial discharge test profiles.

## Absolute Maximum Ratings

Storage Temperature	-55 $^{\circ}C$ to +125 $^{\circ}C$
Operating Temperature	-55 $^{\circ}C$ to +100 $^{\circ}C$
Average Input Current - $I_F$	25 mA <sup>[1]</sup>
Peak Input Current - $I_F$	50 mA <sup>[2]</sup> (50% duty cycle, 1 ms pulse width)
Peak Transient Input Current - $I_F$	1.0 A( $\leq 1$ ms pulse width, 300 pps)
Reverse Input Voltage - $V_R$ (Pin3-1)	5 V
Input Power Dissipation	45 mW <sup>[3]</sup>
Average Output Current - $I_O$ (Pin 5)	8 mA
Peak Output Current	16 mA
Output Voltage - $V_O$ (Pin 5-4)	-0.5 V to 20 V
Supply Voltage - $V_{CC}$ (Pin 6-4)	-0.5 V to 30 V
Output Power Dissipation	100 mW <sup>[4]</sup>
Solder Reflow Temperature Profile	see Package Outline Drawings section

## DC Electrical Specifications

Over recommended temperature ( $T_A = 0^\circ\text{C}$  to  $70^\circ\text{C}$ ) unless otherwise specified.

Parameter	Symbol	Min	Typ.*	Max.	Units	Test Conditions			Fig.	Note
Current Transfer Ratio	CTR	25	32	60	%	$T_A = 25^\circ\text{C}$	$V_O = 0.4\text{ V}$	$I_F = 16\text{ mA}$	1, 2, 4	5
		21	34	$V_O = 0.5\text{ V}$			$V_{CC} = 4.5\text{ V}$			
Current Transfer Ratio	CTR	26	35	65	%	$T_A = 25^\circ\text{C}$	$V_O = 0.4\text{ V}$	$I_F = 12\text{ mA}$	5	
		22	37	$V_O = 0.5\text{ V}$			$V_{CC} = 4.5\text{ V}$			
Logic Low Output Voltage	$V_{OL}$	0.2	0.4	0.4	V	$T_A = 25^\circ\text{C}$	$I_O = 3.0\text{ mA}$	$I_F = 16\text{ mA}$	1	
		0.2	0.5	$I_O = 2.4\text{ mA}$			$V_{CC} = 4.5\text{ V}$			
Logic High Output Current	$I_{OH}$	0.003	0.5	0.5	$\mu\text{A}$	$T_A = 25^\circ\text{C}$	$V_O = V_{CC} = 5.5\text{ V}$	$I_F = 0\text{ mA}$	5	
		0.01	1	1			$V_O = V_{CC} = 15.0\text{ V}$			
		50	50	50						
Logic Low Supply Current	$I_{CCL}$	50	200	200	$\mu\text{A}$	$I_F = 16\text{ mA}, V_{CC} = 15\text{ V}$	$V_O = \text{open}$ ,		11	
Logic High Supply Current	$I_{CCH}$	0.02	1	1	$\mu\text{A}$	$T_A = 25^\circ\text{C}$	$I_F = 16\text{ mA}, V_O = \text{Open}$ ,	$V_{CC} = 15\text{ V}$	11	
		0.02	2	2						
Input Forward Voltage	$V_F$	1.5	1.7	1.7	V	$T_A = 25^\circ\text{C}$	$I_F = 16\text{ mA}$		3	
		1.5	1.8	1.8						
Input Reverse Breakdown Voltage	$BV_R$	5			V	$I_R = 10\ \mu\text{A}$				
Temperature Coefficient of Forward Voltage	$\Delta V_F/\Delta T_A$		-1.6		mV/ $^\circ\text{C}$	$I_F = 16\text{ mA}$				
Input Capacitance	$C_{IN}$		60		pF	$f = 1\text{ MHz}, V_F = 0$				

\*All typicals at  $T_A = 25^\circ\text{C}$ .

## Switching Specifications

Over recommended temperature ( $T_A = 0^\circ\text{C}$  to  $70^\circ\text{C}$ ) unless otherwise specified

Parameter	Symbol	Min.	Typ.*	Max.	Units	Test Conditions	Fig.	Note			
Propagation Delay Time to Logic Low at Output	$t_{PHL}$	0.2	0.3	0.3	$\mu\text{s}$	$T_A = 25^\circ\text{C}$ Pulse: $f = 20\text{ kHz}$ Duty Cycle = 10% $I_F = 16\text{ mA}$ $V_{CC} = 5.0\text{ V}$ $R_L = 1.9\text{ kW}$ $C_L = 15\text{ pF}$ $V_{THHL} = 1.5\text{ V}$	6,8,9	9			
		0.2	0.5	0.5							
		0.2	0.5	0.7					$T_A = 25^\circ\text{C}$ Pulse: $f = 10\text{ kHz}$ Duty Cycle = 50% $I_F = 12\text{ mA}$ $V_{CC} = 15.0\text{ V}$ $R_L = 20\text{ kW}$ $C_L = 100\text{ pF}$ $V_{THHL} = 1.5\text{ V}$	6, 10-14	10
Propagation Delay Time to Logic High at Output	$t_{PLH}$	0.3	0.5	0.5	$\mu\text{s}$	$T_A = 25^\circ\text{C}$ Pulse: $f = 20\text{ kHz}$ Duty Cycle = 10% $I_F = 16\text{ mA}$ $V_{CC} = 5.0\text{ V}$ $R_L = 1.9\text{ kW}$ $C_L = 15\text{ pF}$ $V_{THHL} = 1.5\text{ V}$	6,8,9	9			
		0.3	0.7	0.7							
		0.3	0.8	1.1					$T_A = 25^\circ\text{C}$ Pulse: $f = 10\text{ kHz}$ Duty Cycle = 50% $I_F = 12\text{ mA}$ $V_{CC} = 15.0\text{ V}$ $R_L = 20\text{ kW}$ $C_L = 100\text{ pF}$ $V_{THHL} = 2.0\text{ V}$	6, 10-14	10
Propagation Delay Difference Between Any 2 Parts	$t_{PLH} - t_{PHL}$	-0.4	0.3	0.9	$\mu\text{s}$	$T_A = 25^\circ\text{C}$ Pulse: $f = 10\text{ kHz}$ Duty Cycle = 50% $I_F = 12\text{ mA}$ $V_{CC} = 15.0\text{ V}$ $R_L = 20\text{ kW}$ $C_L = 100\text{ pF}$ $V_{THHL} = 1.5\text{ V}$ $V_{THLH} = 2.0\text{ V}$	6, 10-14	13			
		-0.7	0.3	1.3							
Common Mode Transient Immunity at Logic High Level Output	$ CM_H $	15	30		$\text{kV}/\mu\text{s}$	$T_A = 25^\circ\text{C}$ $V_{CC} = 5.0\text{ V}$ $R_L = 1.9\text{ kW}$ $C_L = 15\text{ pF}$ $I_F = 0\text{ mA}$ $V_{CM} = 1500\text{ V}_{P-P}$	7	7,9			
		15	30						$T_A = 25^\circ\text{C}$ $V_{CC} = 15.0\text{ V}$ $R_L = 20\text{ kW}$ $C_L = 100\text{ pF}$ $I_F = 0\text{ mA}$ $V_{CM} = 1500\text{ V}_{P-P}$	7	8,10
Common Mode Transient Immunity at Logic Low Level Output	$ CM_L $	15	30		$\text{kV}/\mu\text{s}$	$T_A = 25^\circ\text{C}$ $V_{CC} = 5.0\text{ V}$ $R_L = 1.9\text{ kW}$ $C_L = 15\text{ pF}$ $I_F = 16\text{ mA}$ $V_{CM} = 1500\text{ V}_{P-P}$	7	7,9			
		15	30						$T_A = 25^\circ\text{C}$ $V_{CC} = 15.0\text{ V}$ $R_L = 20\text{ kW}$ $C_L = 100\text{ pF}$ $I_F = 12\text{ mA}$ $V_{CM} = 1500\text{ V}_{P-P}$	7	8,10
		15	30						$T_A = 25^\circ\text{C}$ $V_{CC} = 15.0\text{ V}$ $R_L = 20\text{ kW}$ $C_L = 100\text{ pF}$ $I_F = 16\text{ mA}$ $V_{CM} = 1500\text{ V}_{P-P}$	7	8,10

\*All typicals at  $T_A = 25^\circ\text{C}$ .



## Package Characteristics

Over recommended temperature ( $T_A = 0^\circ\text{C}$  to  $70^\circ\text{C}$ ) unless otherwise specified. All typicals at  $T_A = 25^\circ\text{C}$ .

Parameter	Symbol	Min.	Typ.	Max.	Units	Test Conditions	Fig.	Note
Input-Output Momentary Withstand Voltage*	$V_{ISO}$	3750			Vrms	RH $\leq$ 50%, t = 1 min; $T_A = 25^\circ\text{C}$		6,12
Input-Output Resistance	$R_{I-O}$		$10^{12}$		$\Omega$	$V_{I-O} = 500\text{ Vdc}$		6
Input-Output Capacitance	$C_{I-O}$		0.6		pF	f = 1 MHz; $V_{I-O} = 0\text{ Vdc}$		6

\*The Input-Output Momentary Withstand Voltage is a dielectric voltage rating that should not be interpreted as an input-output continuous voltage rating. For the continuous voltage rating refer to the IEC/EN/DIN EN 60747-5-2 Insulation Characteristics Table (if applicable).

### Notes:

- Derate linearly above  $70^\circ\text{C}$  free-air temperature at a rate of  $0.8\text{ mA}/^\circ\text{C}$ .
- Derate linearly above  $70^\circ\text{C}$  free-air temperature at a rate of  $1.6\text{ mA}/^\circ\text{C}$ .
- Derate linearly above  $70^\circ\text{C}$  free-air temperature at a rate of  $0.9\text{ mW}/^\circ\text{C}$ .
- Derate linearly above  $70^\circ\text{C}$  free-air temperature at a rate of  $2.0\text{ mW}/^\circ\text{C}$ .
- CURRENT TRANSFER RATIO in percent is defined as the ratio of output collector current ( $I_O$ ), to the forward LED input current ( $I_F$ ), times 100.
- Device considered a two-terminal device: Pins 1 and 3 shorted together and Pins 4, 5 and 6 shorted together.
- Under TTL load and drive conditions: Common mode transient immunity in a Logic High level is the maximum tolerable (positive)  $dV_{CM}/dt$  on the leading edge of the common mode pulse,  $V_{CM}$ , to assure that the output will remain in a Logic High state (i.e.,  $V_O > 2.0\text{ V}$ ). Common mode transient immunity in a Logic Low level is the maximum tolerable (negative)  $dV_{CM}/dt$  on the trailing edge of the common mode pulse signal,  $V_{CM}$ , to assure that the output will remain in a Logic Low state (i.e.,  $V_O < 0.8\text{ V}$ ).
- Under IPM (Intelligent Power Module) load and LED drive conditions: Common mode transient immunity in a Logic High level is the maximum tolerable  $dV_{CM}/dt$  on the leading edge of the common mode pulse,  $V_{CM}$ , to assure that the output will remain in a Logic High state (i.e.,  $V_O > 3.0\text{ V}$ ). Common mode transient immunity in a Logic Low level is the maximum tolerable  $dV_{CM}/dt$  on the trailing edge of the common mode pulse signal,  $V_{CM}$ , to assure that the output will remain in a Logic Low state (i.e.,  $V_O < 1.0\text{ V}$ ).
- The  $1.9\text{ k}\Omega$  load represents 1 TTL unit load of  $1.6\text{ mA}$  and the  $5.6\text{ k}\Omega$  pull-up resistor.
- The  $R_L = 20\text{ k}\Omega$ ,  $C_L = 100\text{ pF}$  load represents an IPM (Intelligent Power Mode) load.
- Use of a  $0.1\text{ }\mu\text{F}$  bypass capacitor connected between pins 4 and 6 is recommended.
- In accordance with UL 1577, each optocoupler is proof tested by applying an insulation test voltage  $\geq 4500\text{ V}_{RMS}$  for 1 second (leakage detection current limit,  $I_{I-O} \leq 5\text{ }\mu\text{A}$ ).
- The difference between  $t_{PLH}$  and  $t_{PHL}$ , between any two ACPL-W454/P454 parts under the same test condition. (See Power Inverter Dead Time and Propagation Delay Specifications section).

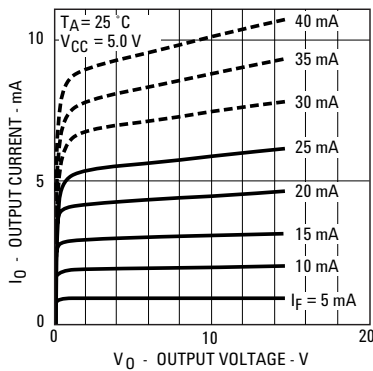

Figure 1. DC and Pulsed Transfer Characteristics.

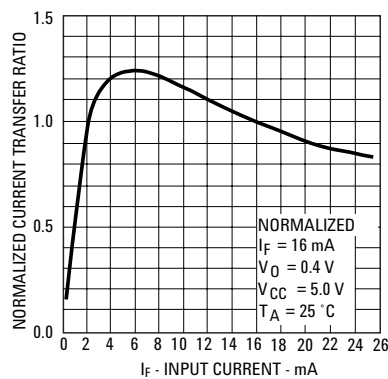

Figure 2. Current Transfer Ratio vs. Input Current.

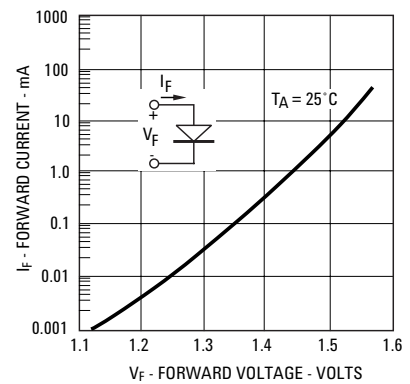

Figure 3. Input Current vs. Forward Voltage.

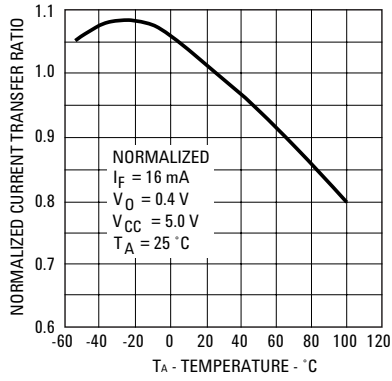

Figure 4. Current Transfer Ratio vs. Temperature.

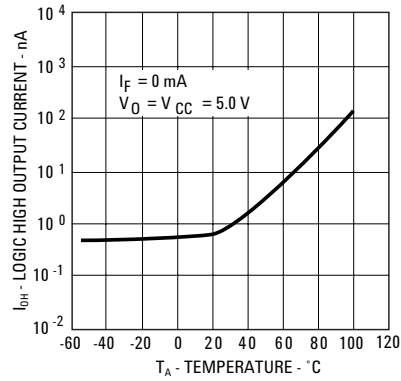

Figure 5. Logic High Output Current vs. Temperature.

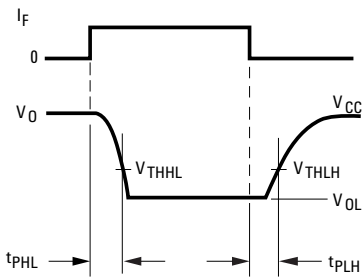

Figure 6. Switching Test Circuit.

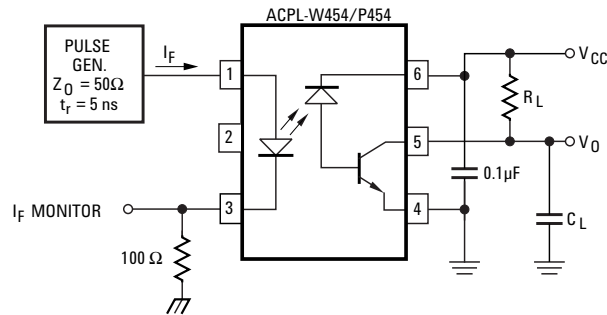

Figure 6. Switching Test Circuit.

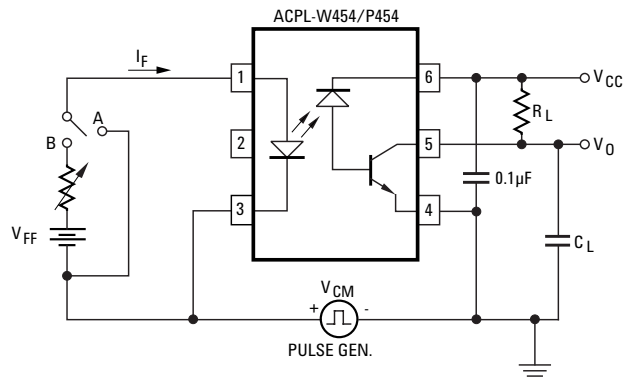
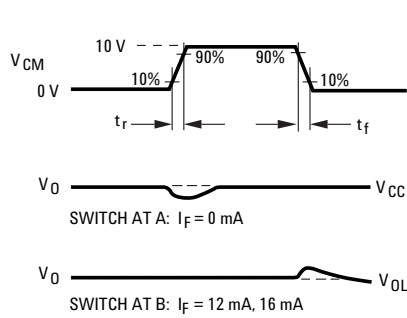

Figure 7. Test Circuit for Transient Immunity and Typical Waveforms.

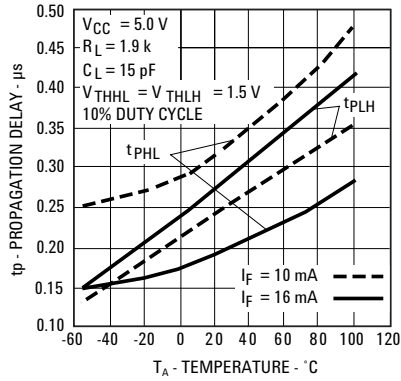

Figure 8. Propagation Delay Time vs. Temperature.

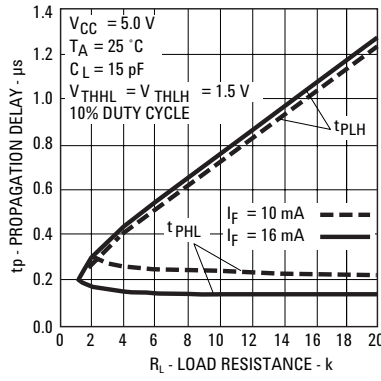

Figure 9. Propagation Delay Time vs. Load Resistance.

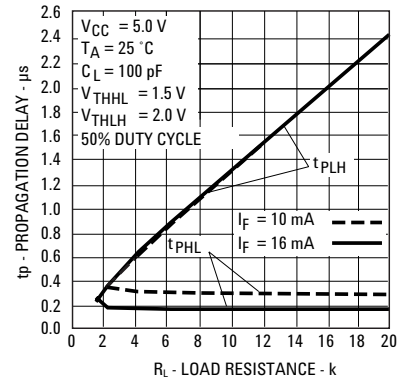

Figure 10. Propagation Delay Time vs. Load Resistance.

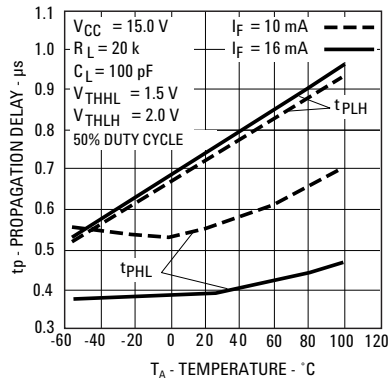

Figure 11. Propagation Delay Time vs. Temperature.

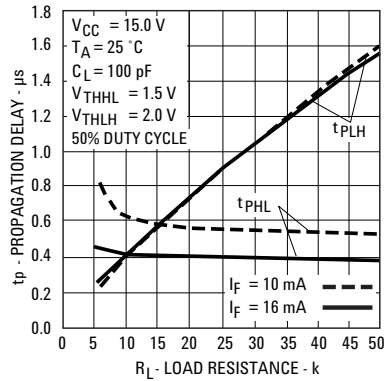

Figure 12. Propagation Delay Time vs. Load Resistance.

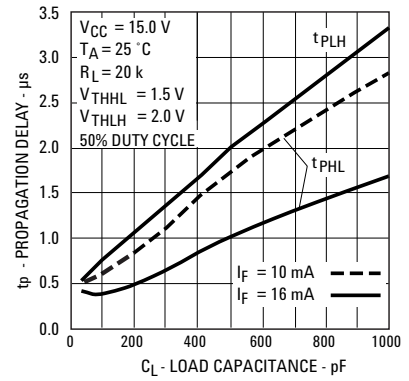

Figure 13. Propagation Delay Time vs. Load Capacitance.

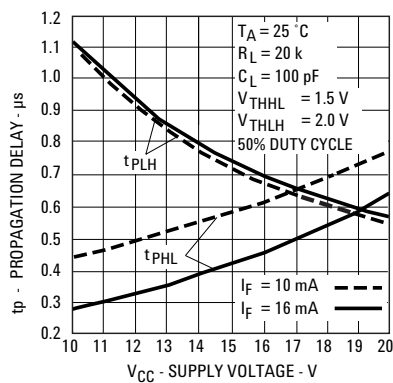

Figure 14. Propagation Delay Time vs. Supply Voltage.

For product information and a complete list of distributors, please go to our web site: [www.avagotech.com](http://www.avagotech.com)

Avago, Avago Technologies, and the A logo are trademarks of Avago Technologies, Limited in the United States and other countries.  
Data subject to change. Copyright © 2007 Avago Technologies Limited. All rights reserved.  
AV01-0253EN - June 13, 2007

