

16-Mbit (2M x 8) Static RAM

Features

- Very high speed: 45 ns
- Wide voltage range: 2.20V – 3.60V
- Ultra low standby power
 - Typical standby current: 1.5 μ A
 - Maximum standby current: 12 μ A
- Ultra low active power
 - Typical active current: 2.2 mA @ f = 1 MHz
- Easy memory expansion with \overline{CE}_1 , CE_2 and \overline{OE} features
- Automatic power down when deselected
- CMOS for optimum speed/power
- Offered in Pb-free 48-ball FBGA package. For Pb-free 48-pin TSOP I package, refer to CY62167EV30 data sheet.

Functional Description^[1]

The CY62168EV30 is a high performance CMOS static RAM organized as 2M words by 8 bits. This device features advanced circuit design to provide an ultra low active current. This is ideal for providing More Battery Life™ (MoBL®) in portable applications such as cellular telephones. The device also has an automatic power down feature that significantly reduces power consumption by 90% when addresses are not

toggling. Placing the device into standby mode reduces power consumption by more than 99% when deselected (Chip Enable 1 (\overline{CE}_1) HIGH or Chip Enable 2 (CE_2) LOW). The input and output pins (IO_0 through IO_7) are placed in a high impedance state when: the device is deselected (Chip Enable 1 (\overline{CE}_1) HIGH or Chip Enable 2 (CE_2) LOW), outputs are disabled (\overline{OE} HIGH), or a write operation is in progress (Chip Enable 1 (\overline{CE}_1) LOW and Chip Enable 2 (CE_2) HIGH and \overline{WE} LOW).

Write to the device by taking Chip Enable 1 (\overline{CE}_1) LOW and Chip Enable 2 (CE_2) HIGH and the Write Enable (\overline{WE}) input LOW. Data on the eight IO pins (IO_0 through IO_7) is then written into the location specified on the address pins (A_0 through A_{20}).

Read from the device by taking Chip Enable 1 (\overline{CE}_1) and Output Enable (\overline{OE}) LOW and Chip Enable 2 (CE_2) HIGH while forcing Write Enable (\overline{WE}) HIGH. Under these conditions, the contents of the memory location specified by the address pins will appear on the IO pins.

The eight input and output pins (IO_0 through IO_7) are placed in a high impedance state when the device is deselected (\overline{CE}_1 LOW and CE_2 HIGH), the outputs are disabled (\overline{OE} HIGH), or a write operation is in progress (\overline{CE}_1 LOW and CE_2 HIGH and \overline{WE} LOW). See the "Truth Table" on page 8 for a complete description of read and write modes.

Logic Block Diagram

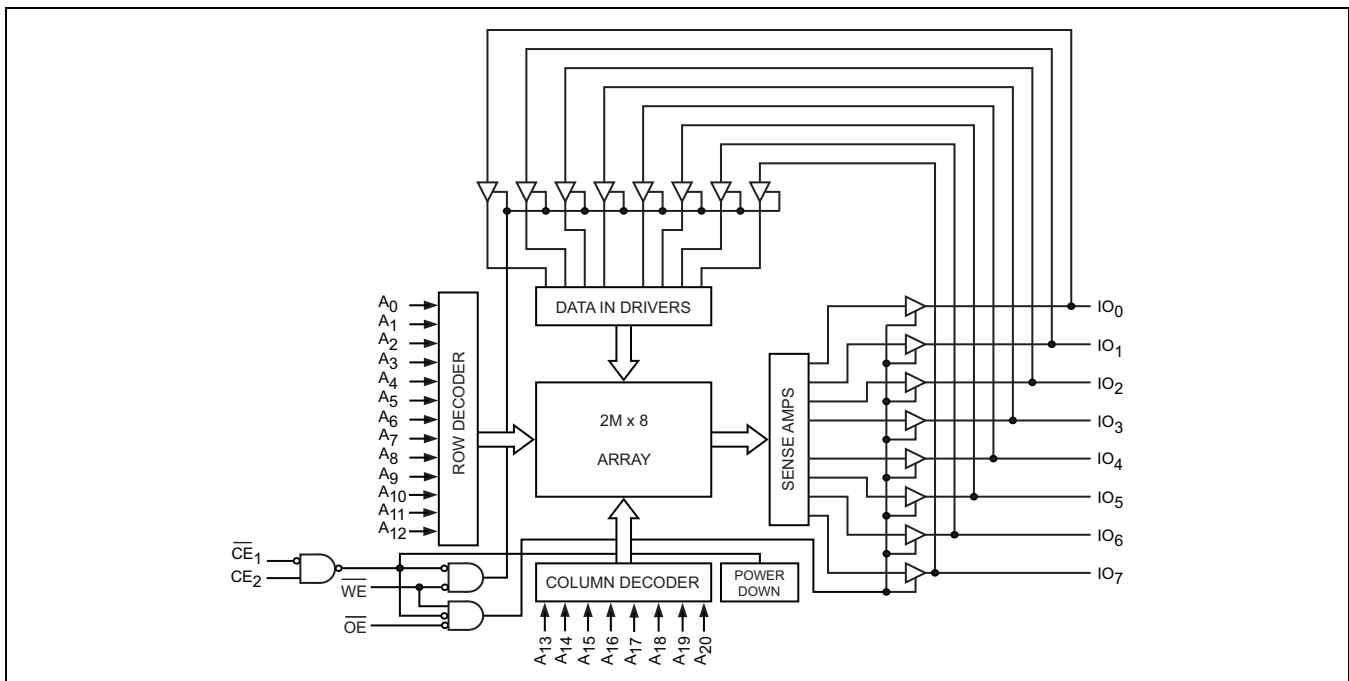

Note

1. For best practice recommendations, refer to the Cypress application note [AN1064, SRAM System Guidelines](#).

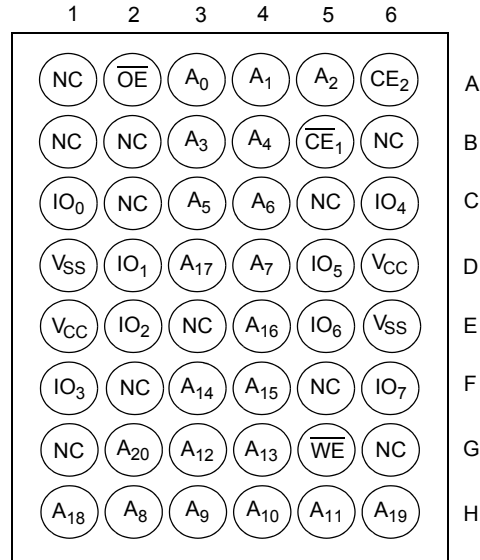
Pin Configuration ^[2]
48-Ball FBGA Top View

Product Portfolio

Product	V _{CC} Range (V)			Speed (ns)	Power Dissipation					
					Operating I _{CC} (mA)				Standby I _{SB2} (μA)	
	f = 1 MHz		f = f _{max}							
	Min	Typ ^[3]	Max		Typ ^[3]	Max	Typ ^[3]	Max	Typ ^[3]	Max
CY62168EV30LL	2.2	3.0	3.6	45	2.2	4.0	25	30	1.5	12

Notes

2. NC pins are not connected on the die.
3. Typical values are included for reference only and are not guaranteed or tested. Typical values are measured at V_{CC} = V_{CC}(typ), T_A = 25°C.

Maximum Ratings

Exceeding the maximum ratings may impair the useful life of the device. These user guidelines are not tested.

Storage Temperature -65°C to +150°C
 Ambient Temperature with Power Applied -55°C to +125°C
 Supply Voltage to Ground Potential -0.3V to $V_{CC}(\text{max}) + 0.3V$
 DC Voltage Applied to Outputs in High-Z State^[4, 5] -0.3V to $V_{CC}(\text{max}) + 0.3V$

DC Input Voltage^[4, 5] -0.3V to $V_{CC}(\text{max}) + 0.3V$
 Output Current into Outputs (LOW) 20 mA
 Static Discharge Voltage > 2001V (MIL-STD-883, Method 3015)
 Latch up Current > 200 mA

Operating Range

Range	Ambient Temperature (T_A) ^[6]	V_{CC} ^[7]
Industrial	-40°C to +85°C	2.2V – 3.6V

DC Electrical Characteristics

Over the Operating Range

Parameter	Description	Test Conditions	CY62168EV30-45			Unit
			Min	Typ ^[3]	Max	
V_{OH}	Output HIGH Voltage	$2.2 \leq V_{CC} \leq 2.7$	$I_{OH} = -0.1 \text{ mA}$		2.0	V
		$2.7 \leq V_{CC} \leq 3.6$	$I_{OH} = -1.0 \text{ mA}$		2.4	
V_{OL}	Output LOW Voltage	$2.2 \leq V_{CC} \leq 2.7$	$I_{OL} = 0.1 \text{ mA}$		0.4	V
		$2.7 \leq V_{CC} \leq 3.6$	$I_{OH} = 2.1 \text{ mA}$		0.4	
V_{IH}	Input HIGH Voltage	$2.2 \leq V_{CC} \leq 2.7$	1.8		$V_{CC} + 0.3$	V
		$2.7 \leq V_{CC} \leq 3.6$	2.2		$V_{CC} + 0.3$	
V_{IL}	Input LOW Voltage	$2.2 \leq V_{CC} \leq 2.7$	-0.3		0.6	V
		$2.7 \leq V_{CC} \leq 3.6$	-0.3		0.8	
I_{IX}	Input Leakage Current	$GND \leq V_I \leq V_{CC}$	-1		+1	μA
I_{OZ}	Output Leakage Current	$GND \leq V_O \leq V_{CC}$, Output disabled	-1		+1	μA
I_{CC}	V_{CC} Operating Supply Current	$f = f_{MAX} = 1/t_{RC}$	$V_{CC} = 3.6V$, $I_{OUT} = 0 \text{ mA}$, CMOS level	25	30	mA
		$f = 1 \text{ MHz}$		2.2	4.0	
I_{SB1}	Automatic CE Power Down Current — CMOS Inputs	$\overline{CE}_1 \geq V_{CC} - 0.2V$, $CE_2 \leq 0.2V$, $V_{IN} \geq V_{CC} - 0.2V$, $V_{IN} \leq 0.2V$, $f = f_{MAX}$ (Address and Data Only), $f = 0$ (OE, WE)		1.5	12	μA
I_{SB2} ^[8]	Automatic CE Power Down Current— CMOS Inputs	$\overline{CE}_1 \geq V_{CC} - 0.2V$, $CE_2 \leq 0.2V$, $V_{IN} \geq V_{CC} - 0.2V$ or $V_{IN} \leq 0.2V$, $f = 0$, $V_{CC} = 3.6V$		1.5	12	μA

Capacitance^[9]

Parameter	Description	Test Conditions	Max	Unit
C_{IN}	Input Capacitance	$T_A = 25^\circ\text{C}$, $f = 1 \text{ MHz}$, $V_{CC} = V_{CC}(\text{typ})$	8	pF
C_{OUT}	Output Capacitance		10	pF

Notes

- $V_{IL}(\text{min}) = -0.2V$ for pulse durations less than 20 ns.
- $V_{IH}(\text{max}) = V_{CC} + 0.75V$ for pulse durations less than 20 ns.
- T_A is the "Instant-On" case temperature.
- Full device AC operation assumes a 100 μs ramp time from 0 to $V_{CC}(\text{min})$ and 100 μs wait time after V_{CC} stabilization.
- Only chip enables (\overline{CE}_1 and CE_2) must be at CMOS level to meet the I_{SB2} / I_{CCDR} spec. Other inputs can be left floating.
- Tested initially and after any design or process changes that may affect these parameters.

Thermal Resistance^[9]

Parameter	Description	Test Conditions	BGA	Unit
Θ_{JA}	Thermal Resistance (Junction to Ambient)	Still Air, soldered on a 3 x 4.5 inch, two-layer printed circuit board	55	°C/W
Θ_{JC}	Thermal Resistance (Junction to Case)		16	°C/W

AC Test Loads and Waveforms

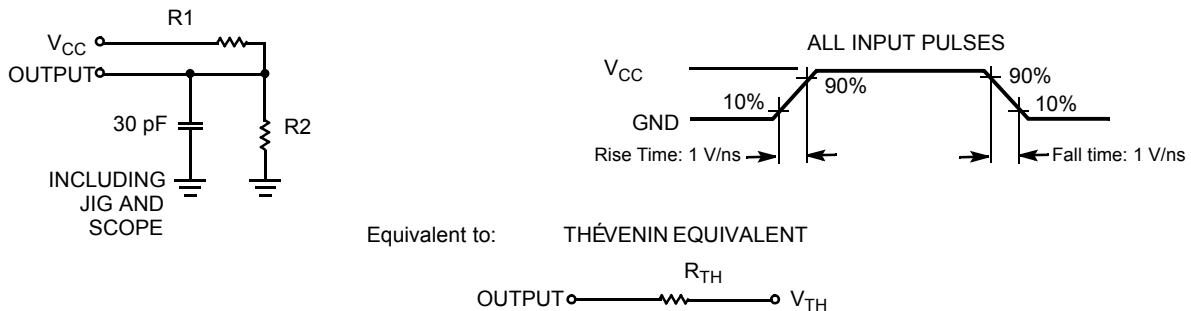

Parameters	2.5V (2.2V to 2.7V)	3.0V (2.7V to 3.6V)	Unit
R1	16600	1103	Ω
R2	15400	1554	Ω
R_{TH}	8000	645	Ω
V_{TH}	1.2	1.75	V

Data Retention Characteristics

Over the Operating Range

Parameter	Description	Conditions	Min	Typ ^[3]	Max	Unit
V_{DR}	V_{CC} for Data Retention		1.5		3.6	V
I_{CCDR} ^[8]	Data Retention Current	$V_{CC} = 1.5V$ $\overline{CE}_1 \geq V_{CC} - 0.2V$ or $CE_2 \leq 0.2V$ $V_{IN} \geq V_{CC} - 0.2V$ or $V_{IN} \leq 0.2V$			10	μA
t_{CDR} ^[9]	Chip Deselect to Data Retention Time		0			ns
t_R ^[10]	Operation Recovery Time		t_{RC}			ns

Data Retention Waveform

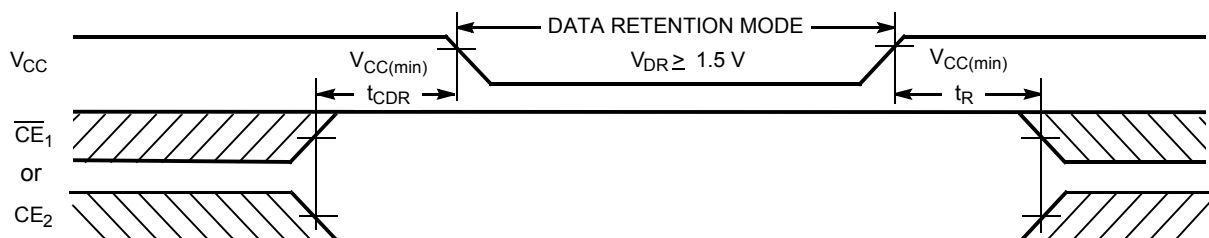

Note

10. Full Device AC operation requires linear V_{CC} ramp from V_{DR} to $V_{CC}(\text{min}) \geq 100 \mu s$ or stable at $V_{CC}(\text{min}) \geq 100 \mu s$.

Switching Characteristics

Over the Operating Range ^[11]

Parameter	Description	45 ns		Unit
		Min	Max	
Read Cycle				
t_{RC}	Read Cycle Time	45		ns
t_{AA}	Address to Data Valid		45	ns
t_{OHA}	Data Hold from Address Change	10		ns
t_{ACE}	\overline{CE}_1 LOW and CE_2 HIGH to Data Valid		45	ns
t_{DOE}	\overline{OE} LOW to Data Valid		22	ns
t_{LZOE}	\overline{OE} LOW to Low Z ^[12]	5		ns
t_{HZOE}	\overline{OE} HIGH to High Z ^[12, 13]		18	ns
t_{LZCE}	\overline{CE}_1 LOW and CE_2 HIGH to Low Z ^[12]	10		ns
t_{HZCE}	\overline{CE}_1 HIGH or CE_2 LOW to High Z ^[12, 13]		18	ns
t_{PU}	\overline{CE}_1 LOW and CE_2 HIGH to Power Up	0		ns
t_{PD}	\overline{CE}_1 HIGH or CE_2 LOW to Power Down		45	ns
Write Cycle^[14]				
t_{WC}	Write Cycle Time	45		ns
t_{SCE}	\overline{CE}_1 LOW and CE_2 HIGH to Write End	35		ns
t_{AW}	Address Setup to Write End	35		ns
t_{HA}	Address Hold from Write End	0		ns
t_{SA}	Address Setup to Write Start	0		ns
t_{PWE}	\overline{WE} Pulse Width	35		ns
t_{SD}	Data Setup to Write End	25		ns
t_{HD}	Data Hold from Write End	0		ns
t_{HZWE}	\overline{WE} LOW to High Z ^[12, 13]		18	ns
t_{LZWE}	\overline{WE} HIGH to Low Z ^[12]	10		ns

Notes

- Test conditions for all parameters other than tri-state parameters assume signal transition time of 3 ns or less (1V/ns), timing reference levels of $V_{CC}(\text{typ})/2$, input pulse levels of 0 to $V_{CC}(\text{typ})$, and output loading of the specified I_{OL}/I_{OH} as shown in "AC Test Loads and Waveforms" on page 4.
- At any given temperature and voltage condition, t_{HZCE} is less than t_{LZCE} , t_{HZOE} is less than t_{LZOE} , and t_{HZWE} is less than t_{LZWE} for any given device.
- t_{HZOE} , t_{HZCE} , and t_{HZWE} transitions are measured when the outputs enter a high impedance state.
- The internal write time of the memory is defined by the overlap of \overline{WE} , $\overline{CE}_1 = V_{IL}$, and $CE_2 = V_{IH}$. All signals must be ACTIVE to initiate a write and any of these signals can terminate a write by going INACTIVE. The data input setup and hold timing should be referenced to the edge of the signal that terminates the write.

Switching Waveforms

Figure 1 shows address transition controlled read cycle waveforms.^[15, 16]

Figure 1. Read Cycle No. 1

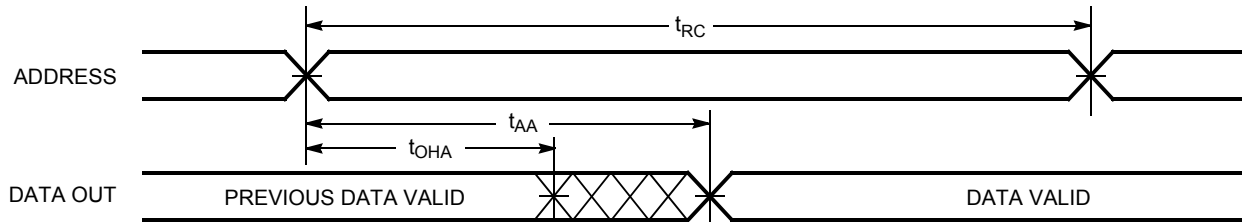
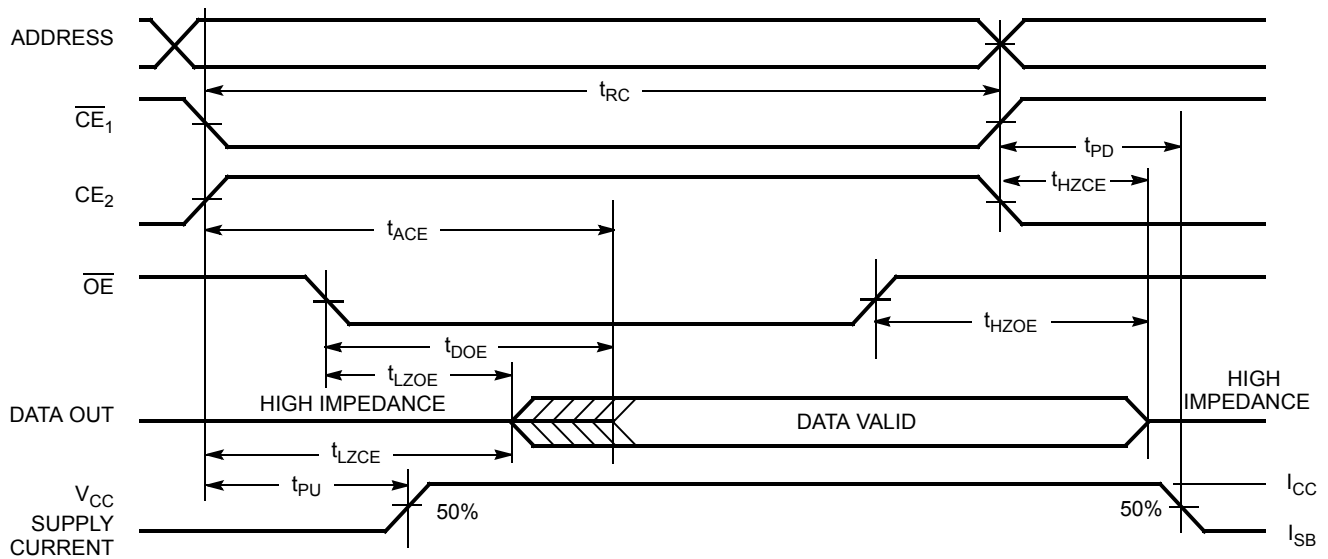

Figure 2 shows \overline{OE} controlled read cycle waveforms.^[16, 17]

Figure 2. Read Cycle No. 2



Notes

- 15. The device is continuously selected. \overline{OE} , $\overline{CE}_1 = V_{IL}$, and $CE_2 = V_{IH}$.
- 16. \overline{WE} is HIGH for read cycle.
- 17. Address valid before or similar to \overline{CE}_1 transition LOW and CE_2 transition HIGH.

Switching Waveforms (continued)

Figure 3 shows \overline{WE} controlled write cycle waveforms.^[14, 18, 19]

Figure 3. Write Cycle No. 1

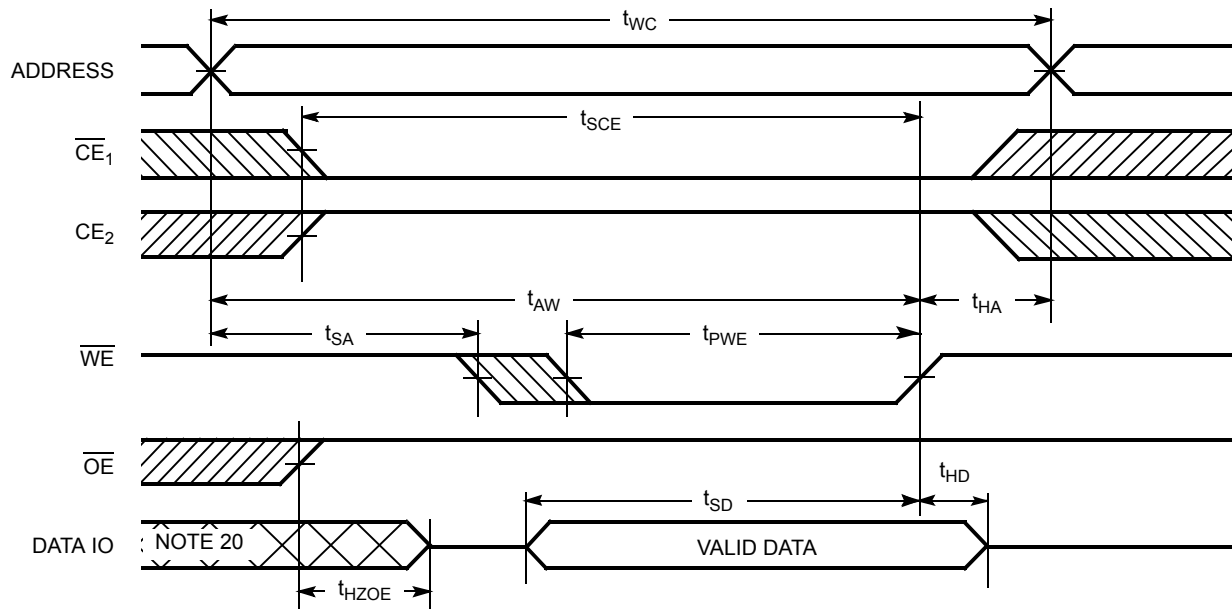
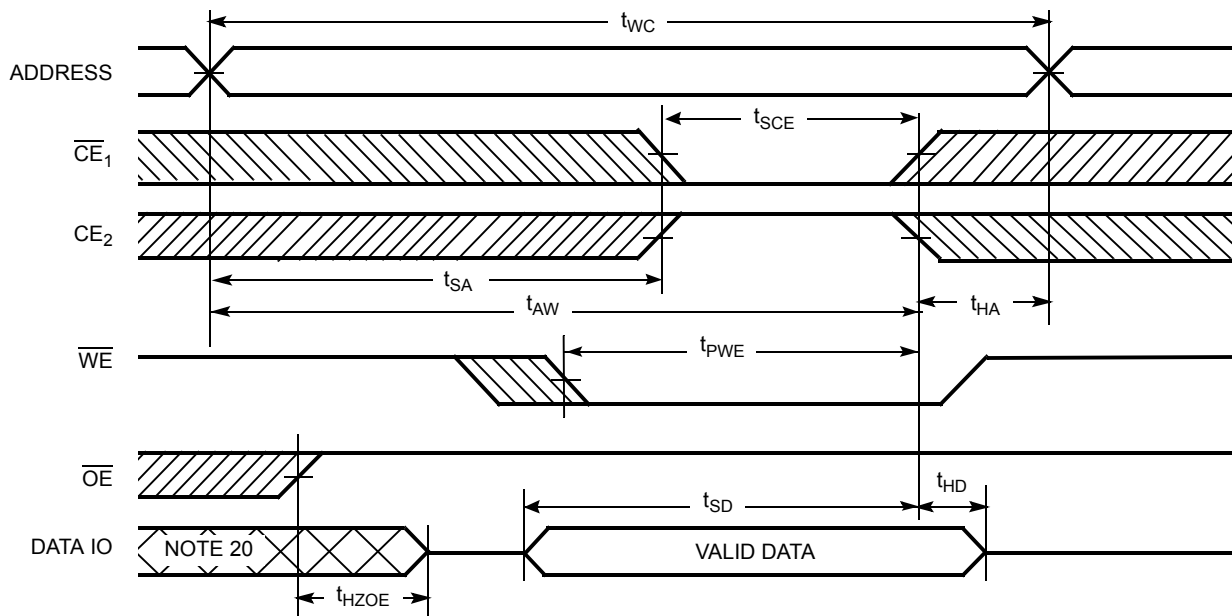

Figure 4 shows \overline{CE}_1 or CE_2 controlled write cycle waveforms.^[14, 18, 19]

Figure 4. Write Cycle No. 2



Notes

18. Data IO is high impedance if $\overline{OE} = V_{IH}$.

19. If \overline{CE}_1 goes HIGH and CE_2 goes LOW simultaneously with $\overline{WE} = V_{IH}$, the output remains in a high impedance state.

20. During this period the IOs are in output state. Do not apply input signals.

Switching Waveforms (continued)

Figure 5 shows \overline{WE} controlled, \overline{OE} LOW write cycle waveforms.^[19]

Figure 5. Write Cycle No. 3

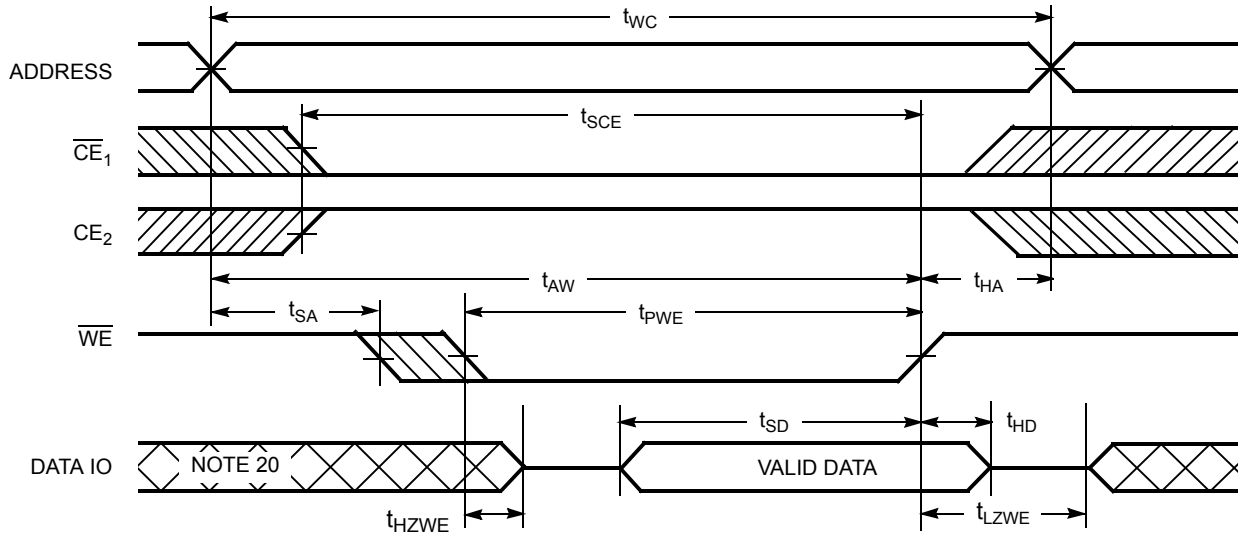

Truth Table

\overline{CE}_1	CE_2	\overline{WE}	\overline{OE}	Inputs/Outputs	Mode	Power
H	X	X	X	High Z	Deselect/Power Down	Standby (I_{SB})
X	L	X	X	High Z	Deselect/Power Down	Standby (I_{SB})
L	H	H	L	Data Out (IO_0 - IO_7)	Read	Active (I_{CC})
L	H	H	H	High Z	Output Disabled	Active (I_{CC})
L	H	L	X	Data in (IO_0 - IO_7)	Write	Active (I_{CC})

Ordering Information

Speed (ns)	Ordering Code	Package Diagram	Package Type	Operating Range
45	CY62168EV30LL-45BVXI	51-85150	48-ball Fine Pitch BGA (Pb-free)	Industrial

Contact your local Cypress sales representative for availability of these parts.

Package Diagrams

Figure 6. 48-Ball VFBGA (6 x 8 x 1 mm), 51-85150

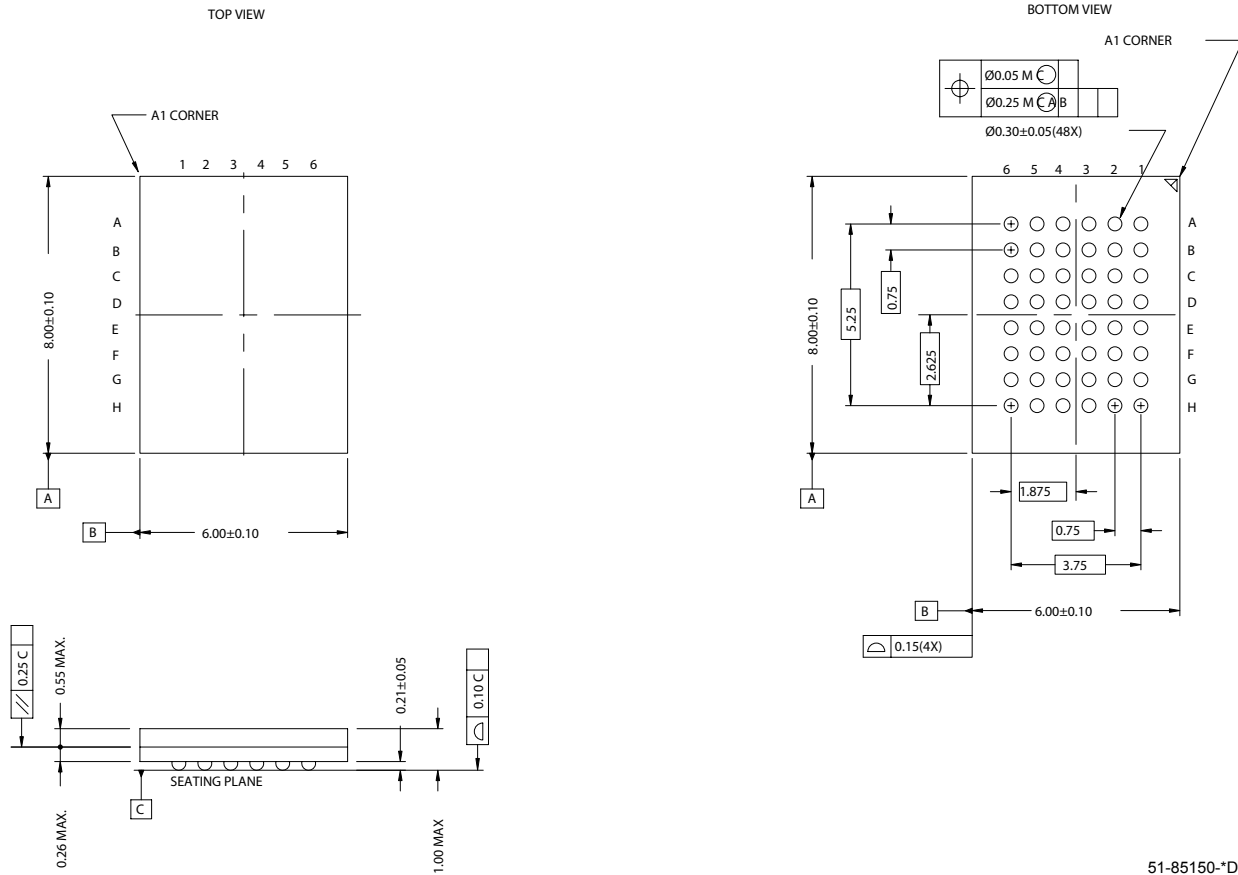

51-85150-*D

© Cypress Semiconductor Corporation, 2006-2007. The information contained herein is subject to change without notice. Cypress Semiconductor Corporation assumes no responsibility for the use of any circuitry other than circuitry embodied in a Cypress product. Nor does it convey or imply any license under patent or other rights. Cypress products are not warranted nor intended to be used for medical, life support, life saving, critical control or safety applications, unless pursuant to an express written agreement with Cypress. Furthermore, Cypress does not authorize its products for use as critical components in life-support systems where a malfunction or failure may reasonably be expected to result in significant injury to the user. The inclusion of Cypress products in life-support systems application implies that the manufacturer assumes all risk of such use and in doing so indemnifies Cypress against all charges.

MoBL is a registered trademark and More Battery Life is a trademark of Cypress Semiconductor. All product and company names mentioned in this document are the trademarks of their respective holders.

Any Source Code (software and/or firmware) is owned by Cypress Semiconductor Corporation (Cypress) and is protected by and subject to worldwide patent protection (United States and foreign), United States copyright laws and international treaty provisions. Cypress hereby grants to licensee a personal, non-exclusive, non-transferable license to copy, use, modify, create derivative works of, and compile the Cypress Source Code and derivative works for the sole purpose of creating custom software and or firmware in support of licensee product to be used only in conjunction with a Cypress integrated circuit as specified in the applicable agreement. Any reproduction, modification, translation, compilation, or representation of this Source Code except as specified above is prohibited without the express written permission of Cypress.

Disclaimer: CYPRESS MAKES NO WARRANTY OF ANY KIND, EXPRESS OR IMPLIED, WITH REGARD TO THIS MATERIAL, INCLUDING, BUT NOT LIMITED TO, THE IMPLIED WARRANTIES OF MERCHANTABILITY AND FITNESS FOR A PARTICULAR PURPOSE. Cypress reserves the right to make changes without further notice to the materials described herein. Cypress does not assume any liability arising out of the application or use of any product or circuit described herein. Cypress does not authorize its products for use as critical components in life-support systems where a malfunction or failure may reasonably be expected to result in significant injury to the user. The inclusion of Cypress' product in a life-support systems application implies that the manufacturer assumes all risk of such use and in doing so indemnifies Cypress against all charges.

Use may be limited by and subject to the applicable Cypress software license agreement.

Document History Page

Document Title: CY62168EV30 MoBL® 16-Mbit (2M x 8) Static RAM				
Document Number: 001-07721				
REV.	ECN NO.	Issue Date	Orig. of Change	Description of Change
**	457686	See ECN	NXR	New Data Sheet
*A	464509	See ECN	NXR	Removed TSOP I package; Added reference to CY62167EV30 TSOP I package which can be used as a 2M x 8 SRAM Changed the $I_{SB2(Typ)}$ value from 1.3 μ A to 1.5 μ A Changed the $I_{CC(Typ)}$ value from 2 mA to 2.2 mA for $f=1$ MHz Test condition Changed the $I_{CC(Typ)}$ value from 15 mA to 22 mA and $I_{CC(Max)}$ value from 40 mA to 25 mA for $f=1$ MHz Test condition Changed the $I_{CCDR(Max)}$ value from 8.5 μ A to 8 μ A
*B	1138883	See ECN	VKN	Converted from preliminary to final Changed $I_{CC(max)}$ spec from 2.8 mA to 4.0 mA for $f=1$ MHz Changed $I_{CC(typ)}$ spec from 22 mA to 25 mA for $f=f_{max}$ Changed $I_{CC(max)}$ spec from 25 mA to 30 mA for $f=f_{max}$ Added footnote# 8 related to I_{SB2} and I_{CCDR} Changed I_{SB1} and I_{SB2} spec from 8.5 μ A to 12 μ A Changed I_{CCDR} spec from 8 μ A to 10 μ A