

**ebm-papst St. Georgen GmbH & Co. KG**

Hermann-Papst-Straße 1

74673 St. Georgen

Phone: +49 7724 81-0

Fax: +49 7724 81-1309

www.ebmpapst.com

info2@de.ebmpapst.com

Nominal data

Type	3218 JN	
Nominal voltage	[VDC]	48
Speed	[min ⁻¹]	6000
Power input	[W]	7.0
Min. ambient temperature	[°C]	-20
Max. ambient temperature	[°C]	70
Air flow	[m ³ /h]	130
Sound power level	[B]	6.1
Sound pressure level	[dB(A)]	51

ml = max. load · me = max. efficiency · rfa = running at free air · cs = customer specs · cu = customer unit
Subject to alterations

Technical features

Dimensions	92 x 92 x 38 mm
General description	Rigid compression curve for high air flow at high counterpressure. Innovative impeller design with winglets for low noise. Optional Vario-Pro: Highly flexible software configuration for the fan ensures an easily customizable solution to meet the individual requirements of your application. Electronic commutation completely integrated.
Connection line	Single strands AWG 24, TR 64, bared and tin-plated.
Locked-rotor protection	With electronic blocking and overload protection
Direction of protection	Right, looking at rotor
Direction of air flow	Air exhaust over bars
Bearing	Ball bearings
Lifetime L10 at 40 °C	70000 h
Lifetime L10 at maximum temperature	35000 h
Mass	0.240 kg
Material of impeller	Fiberglass-reinforced PA plastic
Motor protection	Protected against reverse polarity and locking.
Option	Vario-Pro
Approval	VDE, CSA, UL, CE

Product drawing

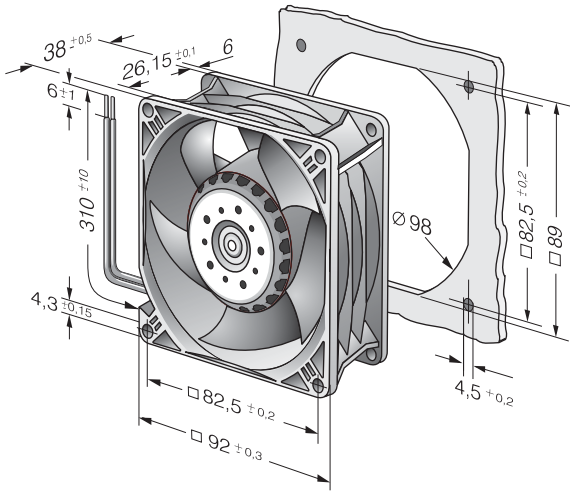

Charts: Air flow

