

4218 NN

## DC axial compact fan



### ebm-papst St. Georgen GmbH & Co. KG

Hermann-Papst-Straße 1

74673 St. Georgen

Phone: +49 7724 81-0

Fax: +49 7724 81-1309

www.ebmpapst.com

info2@de.ebmpapst.com

### Nominal data

Type	4218 NN	
Nominal voltage	[VDC]	48
Speed	[min <sup>-1</sup> ]	2750
Power input	[W]	3.6
Min. ambient temperature	[°C]	-20
Max. ambient temperature	[°C]	70
Air flow	[m <sup>3</sup> /h]	165
Sound power level	[B]	5.4
Sound pressure level	[dB(A)]	42

ml = max. load · me = max. efficiency · rfa = running at free air · cs = customer specs · cu = customer unit  
Subject to alterations

**Technical features**

<b>Dimensions</b>	119 x 119 x 38 mm
<b>General description</b>	DC fan with electronically commutated external rotor motor. Commutation electronics completely integrated.
<b>Connection line</b>	2 single strands AWG 22, TR 64
<b>Locked-rotor protection</b>	Blocking and overload protection
<b>Direction of protection</b>	Left, looking at rotor
<b>Direction of air flow</b>	Air exhaust over bars
<b>Bearing</b>	Ball bearings
<b>Lifetime L10 at 40 °C</b>	60000 h
<b>Lifetime L10 at maximum temperature</b>	30000 h
<b>Mass</b>	0.230 kg
<b>Material of impeller</b>	Fiberglass-reinforced PA plastic
<b>Motor protection</b>	Reverse-polarity protected. The fan runs only if the polarity is correct.
<b>Approval</b>	VDE, CSA, UL, CE

## Product drawing

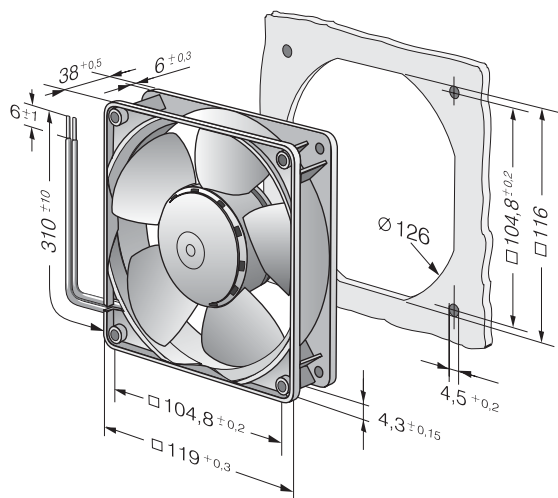

## Charts: Air flow

