

# EFM<sup>®</sup>32

... the world's most energy friendly microcontrollers

## EFM32G210 DATASHEET

EFM32G210F128

Preliminary

0 1 2 3 4

- **ARM Cortex-M3 CPU platform**
  - High Performance 32-bit processor @ up to 32 MHz
  - Memory Protection Unit
  - Wake-up Interrupt Controller
- **Flexible Energy Management System**
  - 20 nA @ 3 V Shutoff Mode
  - 0.6 µA @ 3 V Stop Mode, including Power-on Reset, Brown-out Detector, RAM and CPU retention
  - 0.9 µA @ 3 V Deep Sleep Mode, including Real Time Clock with 32.768 kHz oscillator, Power-on Reset, Brown-out Detector, RAM and CPU retention
  - 45 µA/MHz @ 3 V Sleep Mode
  - 180 µA/MHz @ 3 V Run Mode, with code executed from flash
- **128 KB Flash**
- **16 KB RAM**
- **24 General Purpose I/O pins**
  - Configurable Push-pull, Open-drain, pull-up/down, input filter, drive strength
  - Configurable peripheral I/O locations
  - 16 asynchronous external interrupts
- **8 Channel DMA Controller**
- **8 Channel Peripheral Reflex System for autonomous inter-peripheral signaling**
- **Hardware AES with 128/256-bit keys in 54/75 cycles**
- **Timers/Counters**
  - 2x 16-bit Timer/Counter
    - 2x3 Compare/Capture/PWM channels
    - Dead-Time Insertion on TIMER0
  - 16-bit Low Energy Timer
  - 24-bit Real-Time Counter
  - 8-bit Pulse Counter
    - Asynchronous pulse counting/quadrature decoding
  - Watchdog Timer with dedicated RC oscillator @ 50 nA
- **Communication interfaces**
  - 2x Universal Synchronous/Asynchronous Receiver/Transmitter
    - UART/SPI/SmartCard (ISO 7816)/IrDA
    - Triple buffered full/half-duplex operation
    - 4-16 data bits
  - Low Energy UART
    - Autonomous operation with DMA in Deep Sleep Mode
  - I<sup>2</sup>C Interface with SMBus support
    - Address recognition in Stop Mode
- **Ultra low power precision analog peripherals**
  - 12-bit 1 Msamples/s Analog to Digital Converter
    - 8 single ended channels/4 differential channels
    - On-chip temperature sensor
    - Conversion tailgating for predictable latency
  - 12-bit 500 ksamples/s Digital to Analog Converter
  - 2x Analog Comparator
    - Programmable speed/current
    - Capacitive sensing with up to 8 inputs
  - Supply Voltage Comparator
- **Ultra efficient Power-on Reset and Brown-Out Detector**
- **2-pin Serial Wire Debug interface**
  - 1-pin Serial Wire Viewer
- **Temperature range -40 to 85 °C**
- **Single power supply 1.8 to 3.8 V**
- **QFN32 package**

EFM32G210 microcontrollers are suited for all battery operated applications

Energy Metering



Industrial/ Home Automation

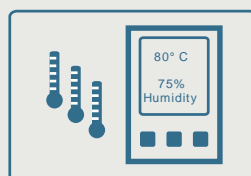

Wireless Alarm/ Security

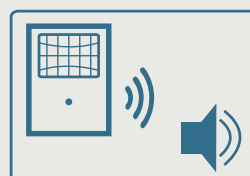

Medical Systems



# 1 Ordering Information

Table 1.1 (p. 2) shows the available EFM32G210 devices.

**Table 1.1. Ordering Information**

Ordering Code	Flash (KB)	RAM (KB)	Max Speed (MHz)	Supply Voltage	Temperature	Package
EFM32G210F128-QFN32	128	16	32	1.8 to 3.8V	-40 to 85 °C	QFN32

Visit [www.energymicro.com](http://www.energymicro.com) for information on global distributors and representatives or contact [sales@energymicro.com](mailto:sales@energymicro.com) for additional information.

## 1.1 Block Diagram

A block diagram of the EFM32G210 is shown in Figure 1.1 (p. 2) .

**Figure 1.1. Block Diagram**

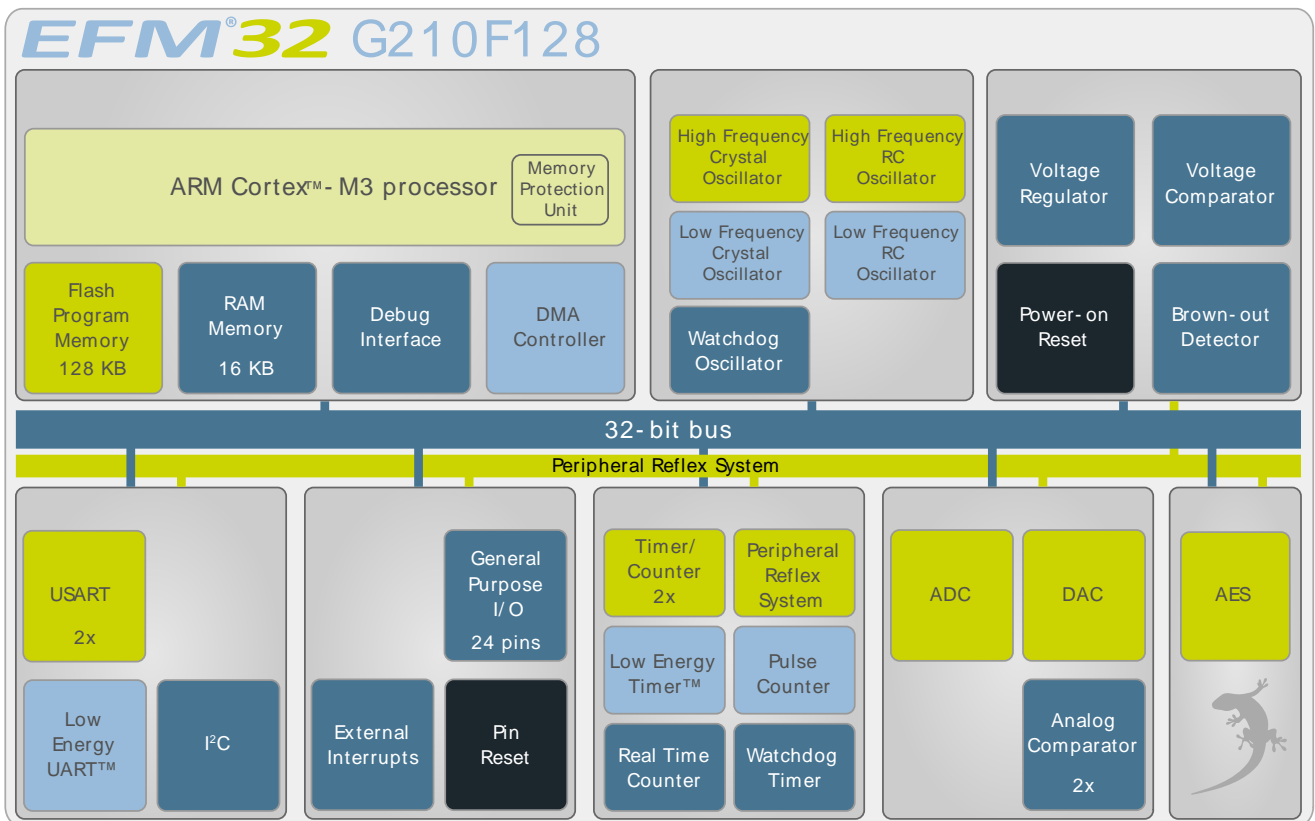

## 2 System Summary

### 2.1 System Introduction

The EFM32G family of MCUs is the world's most energy friendly microcontroller. With a unique combination of the powerful 32-bit ARM Cortex-M3, innovative low energy techniques, short wake-up time from energy saving modes, and a wide selection of peripherals, the EFM32G microcontroller is well suited for any battery operated application as well as other systems requiring high performance and low-energy consumption. This section gives a short introduction to each of the modules in general terms and also shows a summary of the configuration for the EFM32G210 devices. For a complete feature set and in-depth information on the modules, the reader is referred to the *EFM32G Reference Manual*.

#### 2.1.1 ARM Cortex-M3 Core

The ARM Cortex-M3 includes a 32-bit RISC processor which can achieve as much as 1.25 Dhrystone MIPS/MHz. A Memory Protection Unit with support for up to 8 memory segments is included, as well as a Wake-up Interrupt Controller handling interrupts triggered while the CPU is asleep. The EFM32 implementation of the Cortex-M3 is described in detail in *EFM32G Cortex-M3 Reference Manual*.

#### 2.1.2 Debug Interface (DBG)

This device includes hardware debug support through a 2-pin serial-wire debug interface. In addition there is also a 1-wire Serial Wire Viewer pin which can be used to output profiling information, data trace and software-generated messages.

#### 2.1.3 Memory System Controller (MSC)

The Memory System Controller (MSC) is the program memory unit of the EFM32G microcontroller. The flash memory is readable and writable from both the Cortex-M3 and DMA. The flash memory is divided into two blocks; the main block and the information block. Program code is normally written to the main block. Additionally, the information block is available for special user data and flash lock bits. There is also a read-only page in the information block containing system and device calibration data. Read and write operations are supported in the energy modes EM0 and EM1.

#### 2.1.4 Direct Memory Access Controller (DMA)

The Direct Memory Access (DMA) controller performs memory operations independently of the CPU. This has the benefit of reducing the energy consumption and the workload of the CPU, and enables the system to stay in low energy modes when moving for instance data from the USART to RAM or from the External Bus Interface to the DAC. The DMA controller uses the PL230  $\mu$ DMA controller licensed from ARM.

#### 2.1.5 Reset Management Unit (RMU)

The RMU is responsible for handling the reset functionality of the EFM32G.

#### 2.1.6 Energy Management Unit (EMU)

The Energy Management Unit (EMU) manage all the low energy modes (EM) in EFM32G microcontrollers. Each energy mode manages if the CPU and the various peripherals are available. The EMU can also be used to turn off the power to unused SRAM blocks.

#### 2.1.7 Clock Management Unit (CMU)

The Clock Management Unit (CMU) is responsible for controlling the oscillators and clocks on-board the EFM32G. The CMU provides the capability to turn on and off the clock on an individual basis to all

peripheral modules in addition to enable/disable and configure the available oscillators. The high degree of flexibility enables software to minimize energy consumption in any specific application by not wasting power on peripherals and oscillators that are inactive.

### 2.1.8 Watchdog (WDOG)

The purpose of the watchdog timer is to generate a reset in case of a system failure, to increase application reliability. The failure may e.g. be caused by an external event, such as an ESD pulse, or by a software failure.

### 2.1.9 Peripheral Reflex System (PRS)

The Peripheral Reflex System (PRS) system is a network which lets the different peripheral module communicate directly with each other without involving the CPU. Peripheral modules which send out Reflex signals are called producers. The PRS routes these reflex signals to consumer peripherals which apply actions depending on the data received. The format for the Reflex signals is not given, but edge triggers and other functionality can be applied by the PRS.

### 2.1.10 Inter-Integrated Circuit Interface (I2C)

The I<sup>2</sup>C module provides an interface between the MCU and a serial I<sup>2</sup>C-bus. It is capable of acting as both a master and a slave, and supports multi-master buses. Both standard-mode, fast-mode and fast-mode plus speeds are supported, allowing transmission rates all the way from 10 kbit/s up to 1 Mbit/s. Slave arbitration and timeouts are also provided to allow implementation of an SMBus compliant system. The interface provided to software by the I<sup>2</sup>C module, allows both fine-grained control of the transmission process and close to automatic transfers. Automatic recognition of slave addresses is provided in all energy modes.

### 2.1.11 Universal Synchronous/Asynchronous Receiver/Transmitter (USART)

The Universal Synchronous Asynchronous serial Receiver and Transmitter (USART) is a very flexible serial I/O module. It supports full duplex asynchronous UART communication as well as RS-485, SPI, MicroWire and 3-wire. It can also interface with ISO7816 SmartCards, and IrDA devices.

### 2.1.12 Low Energy Universal Asynchronous Receiver/Transmitter (LEUART)

The unique LEUART<sup>™</sup>, the Low Energy UART, is a UART that allows two-way UART communication on a strict power budget. Only a 32.768 kHz clock is needed to allow UART communication up to 9600 baud/s. The LEUART includes all necessary hardware support to make asynchronous serial communication possible with minimum of software intervention and energy consumption.

### 2.1.13 Timer/Counter (TIMER)

The 16-bit general purpose Timer has 3 compare/capture channels for input capture and compare/Pulse-Width Modulation (PWM) output. TIMER0 also includes a Dead-Time Insertion module suitable for motor control applications.

### 2.1.14 Real Time Counter (RTC)

The Real Time Counter (RTC) contains a 24-bit counter and is clocked either by a 32.768 kHz crystal oscillator, or a 32 kHz RC oscillator. In addition to energy modes EM0 and EM1, the RTC is also available in EM2. This makes it ideal for keeping track of time since the RTC is enabled in EM2 where most of the device is powered down.

### 2.1.15 Low Energy Timer (LETIMER)

The unique LETIMER<sup>™</sup>, the Low Energy Timer, is a 16-bit timer that is available in energy mode EM2 in addition to EM1 and EM0. Because of this, it can be used for timing and output generation when most of the device is powered down, allowing simple tasks to be performed while the power consumption of the system is kept at an absolute minimum. The LETIMER can be used to output a variety of waveforms with minimal software intervention. It is also connected to the Real Time Counter (RTC), and can be configured to start counting on compare matches from the RTC.

### 2.1.16 Pulse Counter (PCNT)

The Pulse Counter (PCNT) can be used for counting pulses on a single input or to decode quadrature encoded inputs. It runs off either the internal LFACTLK or the PCNTn\_S0IN pin as external clock source. The module may operate in energy mode EM0 – EM3.

### 2.1.17 Analog Comparator (ACMP)

The Analog Comparator is used to compare the voltage of two analog inputs, with a digital output indicating which input voltage is higher. Inputs can either be one of the selectable internal references or from external pins. Response time and thereby also the current consumption can be configured by altering the current supply to the comparator.

### 2.1.18 Voltage Comparator (VCMP)

The Voltage Supply Comparator is used to monitor the supply voltage from software. An interrupt can be generated when the supply falls below or rises above a programmable threshold. Response time and thereby also the current consumption can be configured by altering the current supply to the comparator.

### 2.1.19 Analog to Digital Converter (ADC)

The ADC is a Successive Approximation Register (SAR) architecture, with a resolution of up to 12 bits at up to one million samples per second. The integrated input mux can select inputs from 8 external pins and 6 internal signals.

### 2.1.20 Digital to Analog Converter (DAC)

The Digital to Analog Converter (DAC) can convert a digital value to an analog output voltage. The DAC is fully differential rail-to-rail, with 12-bit resolution. It has one single ended output buffer connected to channel 0. The DAC may be used for a number of different applications such as sensor interfaces or sound output.

### 2.1.21 Advanced Encryption Standard Accelerator (AES)

The AES accelerator performs AES encryption and decryption with 128-bit or 256-bit keys. Encrypting or decrypting one 128-bit data block takes 52 HFCORECLK cycles with 128-bit keys and 75 HFCORECLK cycles with 256-bit keys. The AES module is an AHB slave which enables efficient access to the data and key registers. All write accesses to the AES module must be 32-bit operations, i.e. 8- or 16-bit operations are not supported.

### 2.1.22 General Purpose Input/Output (GPIO)

In the EFM32G210, there are 24 General Purpose Input/Output (GPIO) pins, which are divided into ports with up to 16 pins each. These pins can individually be configured as either an output or input. More advanced configurations like open-drain, filtering and drive strength can also be configured individually for the pins. The GPIO pins can also be overridden by peripheral pin connections, like Timer PWM

outputs or USART communication, which can be routed to several locations on the device. The GPIO supports up to 16 asynchronous external pin interrupts, which enables interrupts from any pin on the device. Also, the input value of a pin can be routed through the Peripheral Reflex System to other peripherals.

## 2.2 Configuration Summary

The features of the EFM32G210 is a subset of the feature set described in the EFM32G Reference Manual. Table 2.1 (p. 6) describes device specific implementation of the features.

**Table 2.1. Configuration Summary**

Module	Configuration	Pin Connections
Cortex-M3	Full configuration	NA
DBG	Full configuration	DBG_SWCLK, DBG_SWDIO, DBG_SWV
MSC	Full configuration	NA
DMA	Full configuration	NA
RMU	Full configuration	NA
EMU	Full configuration	NA
CMU	Full configuration	CMU_OUT0, CMU_OUT1
WDOG	Full configuration	NA
PRS	Full configuration	NA
I2C0	Full configuration	I2C0_SDA, I2C0_SCL
USART0	Full configuration	US0_TX, US0_RX, US0_CLK, US0_CS
USART1	No IrDA	US1_TX, US1_RX, US1_CLK, US1_CS
LEUART0	Full configuration	LEU0_TX, LEU0_RX
TIMER0	Full configuration	TIM0_CC[2:0], TIM0_CDTI[2:0]
TIMER1	No DTI	TIM1_CC[2:0]
RTC	Full configuration	NA
LETIMER0	Full configuration	LET0_O[1:0]
PCNT0	8-bit count register	PCNT0_S[1:0]
ACMP0	Full configuration	ACMP0_CH[1:0], ACMP0_O
ACMP1	Full configuration	ACMP1_CH[7:5], ACMP1_O
VCMP	Full configuration	NA
ADC0	Full configuration	ADC0_CH[7:4]
DAC0	Full configuration	DAC0_OUT[0]
AES	Full configuration	NA
GPIO	24 pins	Available pins are shown in Table 4.2 (p. 30)

## 2.3 Memory Map

The *EFM32G210* memory map is shown in Figure 2.1 (p. 7), with RAM and Flash sizes for the largest memory configuration.

Figure 2.1. EFM32G210 Memory Map with largest RAM and Flash sizes

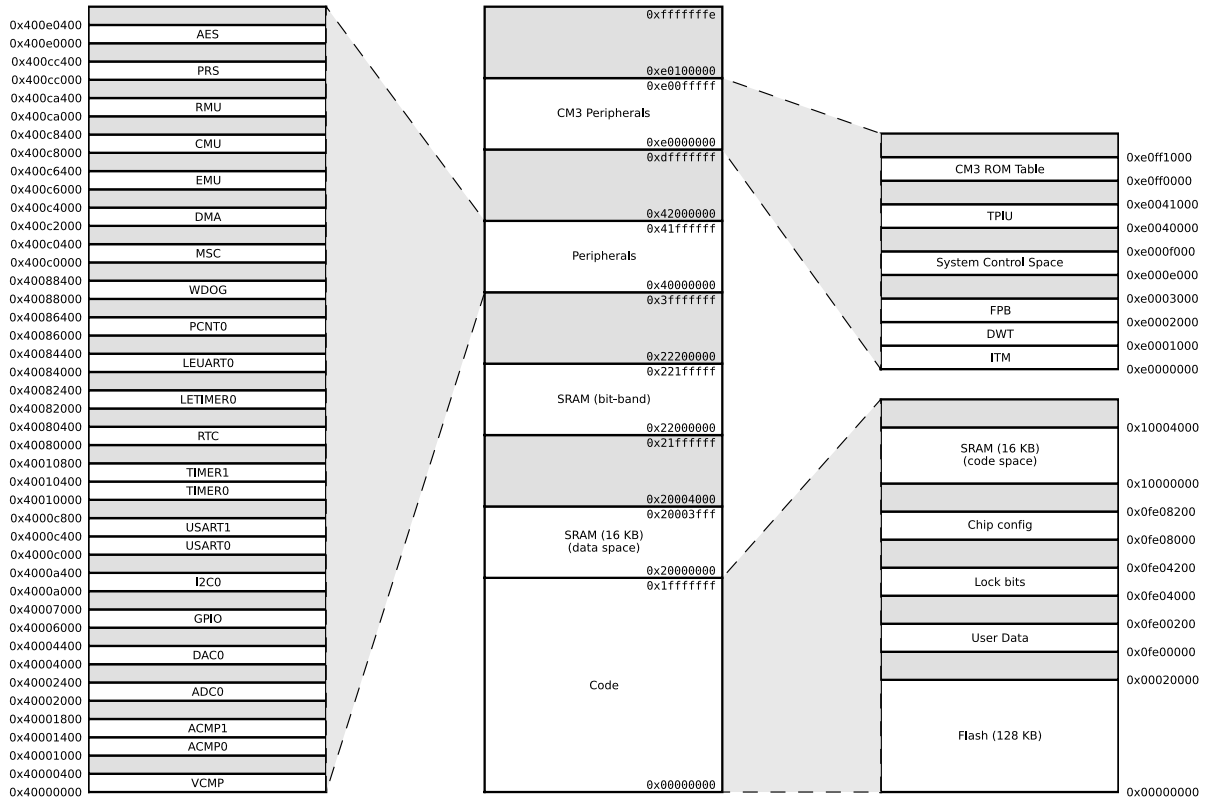

## 3 Electrical Characteristics

### 3.1 Test Conditions

#### 3.1.1 Introduction

Unless otherwise specified data in this chapter is preliminary and subject to change without further notice.

#### 3.1.2 Typical Values

The typical data are based on  $T_{AMB}=25^{\circ}\text{C}$  and  $V_{DD}=3.0\text{ V}$ , as defined in Table 3.2 (p. 8), by simulation and/or technology characterisation unless otherwise specified.

#### 3.1.3 Minimum and Maximum Values

The minimum and maximum values represent the worst conditions of ambient temperature, supply voltage and frequencies, as defined in Table 3.2 (p. 8), by simulation and/or technology characterisation unless otherwise specified.

## 3.2 Absolute Maximum Ratings

The absolute maximum ratings are stress ratings, and functional operation under such conditions are not guaranteed. Stress beyond the limits specified in Table 3.1 (p. 8) may affect the device reliability or cause permanent damage to the device. Functional operating conditions are given in Table 3.2 (p. 8).

**Table 3.1. Absolute Maximum Ratings**

Symbol	Parameter	Condition	Min	Typ	Max	Unit
$T_{STG}$	Storage temperature range		-40		85	$^{\circ}\text{C}$
$T_J$	Maximum junction temperature	JEDEC J-STD-020D			260	$^{\circ}\text{C}$
$V_{DDMAX}$	External main supply voltage		0		3.8	V
$V_{IOPIN}$	Voltage on any I/O pin		-0.3		$V_{DD}+0.3$	V

## 3.3 General Operating Conditions

### 3.3.1 General Operating Conditions

**Table 3.2. General Operating Conditions**

Symbol	Parameter	Min	Typ	Max	Unit
$T_{AMB}$	Ambient temperature range	-40	25	85	$^{\circ}\text{C}$
$V_{DDOP}$	Operating supply voltage	1.8	3.0	3.8	V
$f_{APB}$	Internal APB clock frequency			32	MHz
$f_{AHB}$	Internal AHB clock frequency			32	MHz



### 3.3.2 Environmental

**Table 3.3. Environmental**

Symbol	Parameter	Condition	Min	Typ	Max	Unit
V <sub>ESDHBM</sub>	ESD (Human Body Model HBM)	T <sub>AMB</sub> =25°C			2	kV
V <sub>ESDCDM</sub>	ESD (Charged Device Model, CDM)	T <sub>AMB</sub> =25°C			500	V
MSL	Moisture sensitivity level	JEDEC J-STD-20D. Level 3			168	hrs
LU	Latchup sensitivity	JESD78 Latchup test procedure. Class II level A.			85	°C

### 3.4 Current Consumption

**Table 3.4. Current Consumption**

Symbol	Parameter	Condition	Min	Typ	Max	Unit
I <sub>EM0</sub>	EM0 current. No prescaling. Running code from Flash.	32 MHz HFXO, all peripheral clocks disabled, V <sub>DD</sub> = 3.0 V		180		μA/ MHz
		28 MHz HFRCO, all peripheral clocks disabled, V <sub>DD</sub> = 3.0 V		190	240	μA/ MHz
		32 MHz HFXO, all peripheral clocks enabled, V <sub>DD</sub> = 3.0 V		TBD		μA/ MHz
		14 MHz HFRCO. all peripheral clocks enabled.		TBD		μA/ MHz
		1 MHz HFRCO, all peripheral clocks disabled, V <sub>DD</sub> = 3.0 V			220	
I <sub>EM1</sub>	EM1 current	32 MHz HFXO, all peripheral clocks disabled, V <sub>DD</sub> = 3.0 V		45		μA/ MHz
		28 MHz HFRCO, all peripheral clocks disabled, V <sub>DD</sub> = 3.0 V		48	55	μA/ MHz
		1 MHz HFRCO. all peripheral clocks disabled, V <sub>DD</sub> = 3.0 V		103		μA/ MHz
I <sub>EM2</sub>	EM2 current	EM2 current with RTC at 1 Hz, 32 kHz LFRCO, V <sub>DD</sub> = 3.0 V, T <sub>AMB</sub> =25°C		0.9		μA
		EM2 current with RTC at 1 Hz, 32 kHz LFRCO, V <sub>DD</sub> = 3.0 V, T <sub>AMB</sub> =85°C		1.7	3.6	μA
I <sub>EM3</sub>	EM3 current	V <sub>DD</sub> = 3.0 V, T <sub>AMB</sub> =25°C		0.59		μA
		V <sub>DD</sub> = 3.0 V, T <sub>AMB</sub> =85°C		1.27	2.7	μA
I <sub>EM4</sub>	EM4 current	V <sub>DD</sub> = 3.0 V, T <sub>AMB</sub> =25°C		0.02		μA
		V <sub>DD</sub> = 3.0 V, T <sub>AMB</sub> =85°C		0.12	0.5	μA

Figure 3.1. EM0 Current consumption vs supply voltage, executing code from flash with HFRCO running at 28MHz

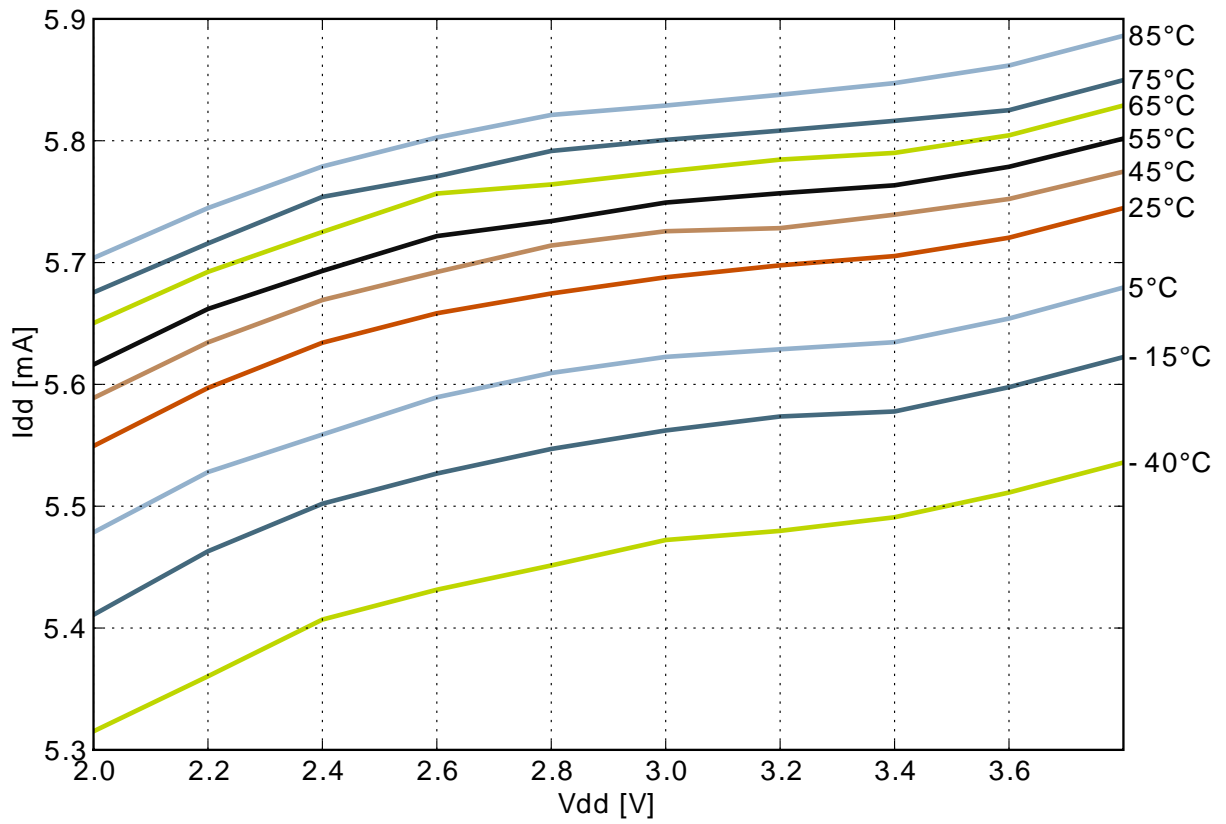
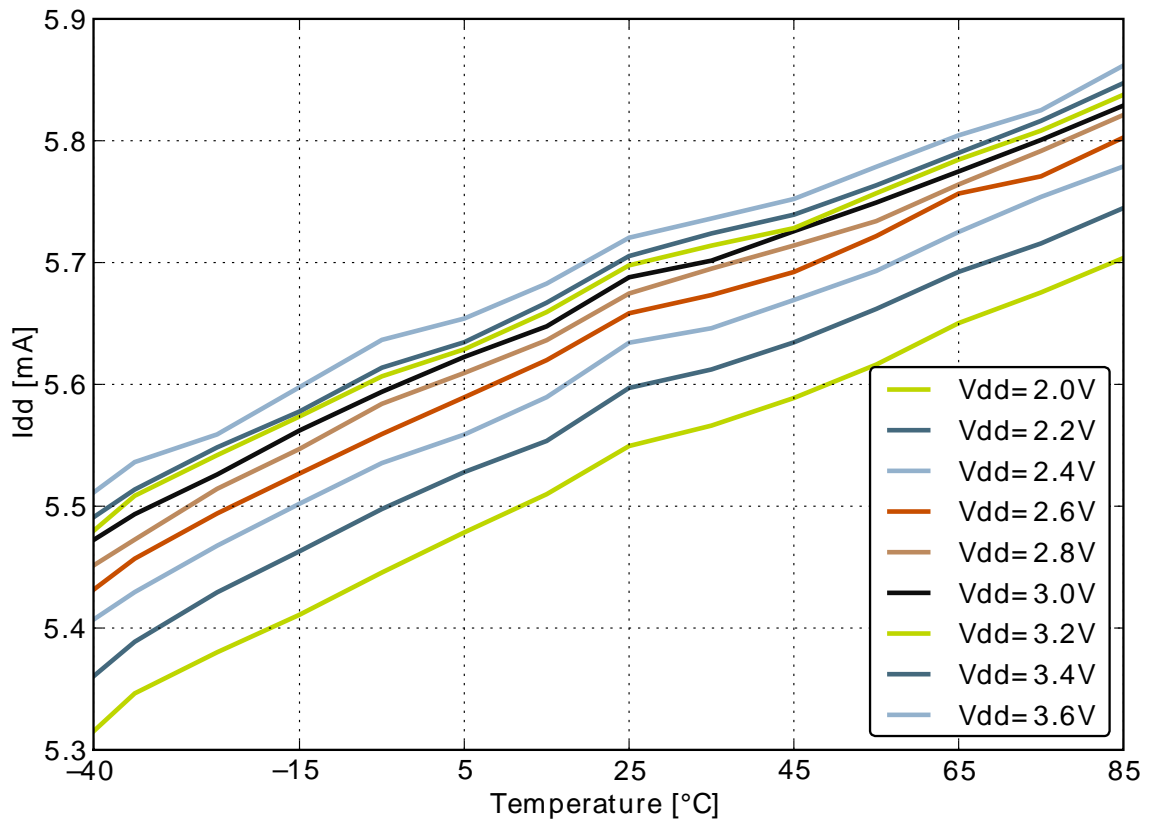

Figure 3.2. EM0 Current consumption vs temperature, executing code from flash with HFRCO running at 28MHz



**Figure 3.3. EM1 Current consumption vs supply voltage, all peripheral clocks disabled, HFRCO running at 28MHz**

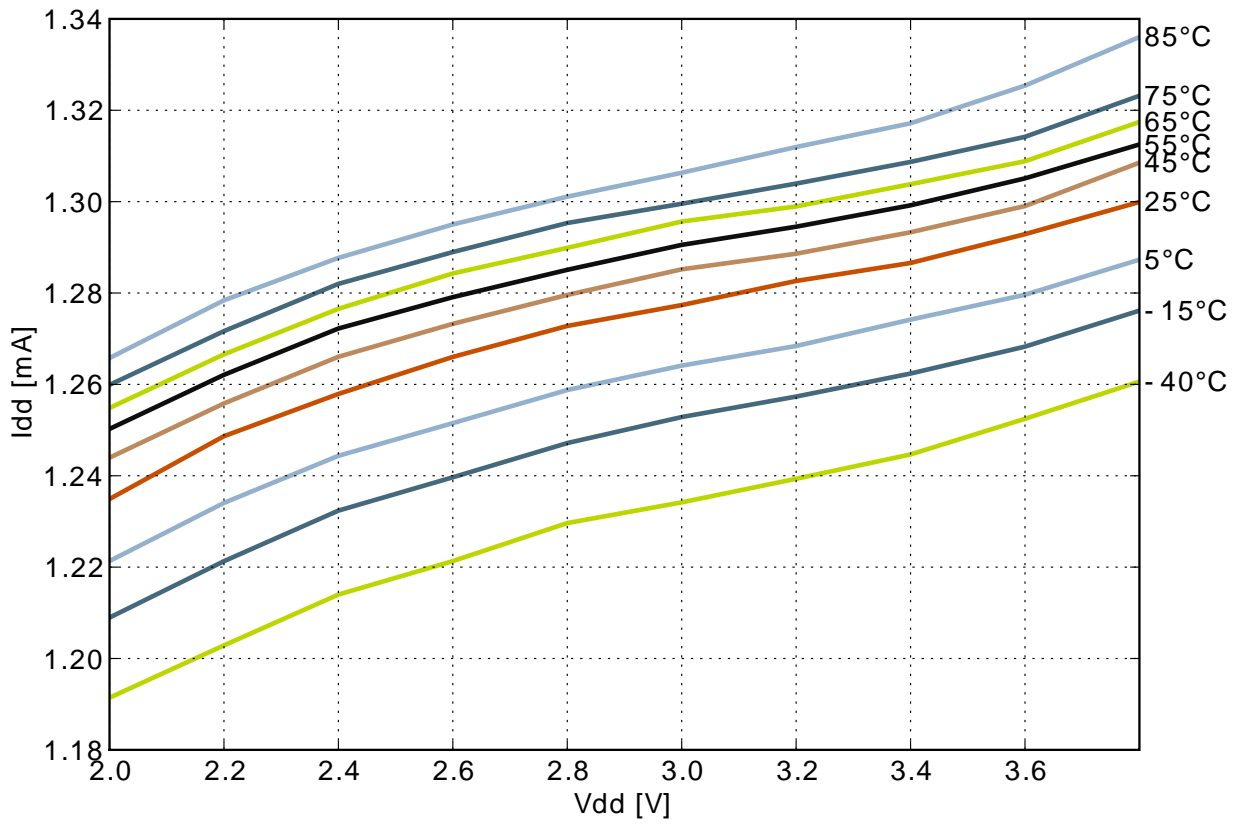

Figure 3.4. EM1 Current consumption vs temperature, all peripheral clocks disabled, HFRCO running at 28MHz

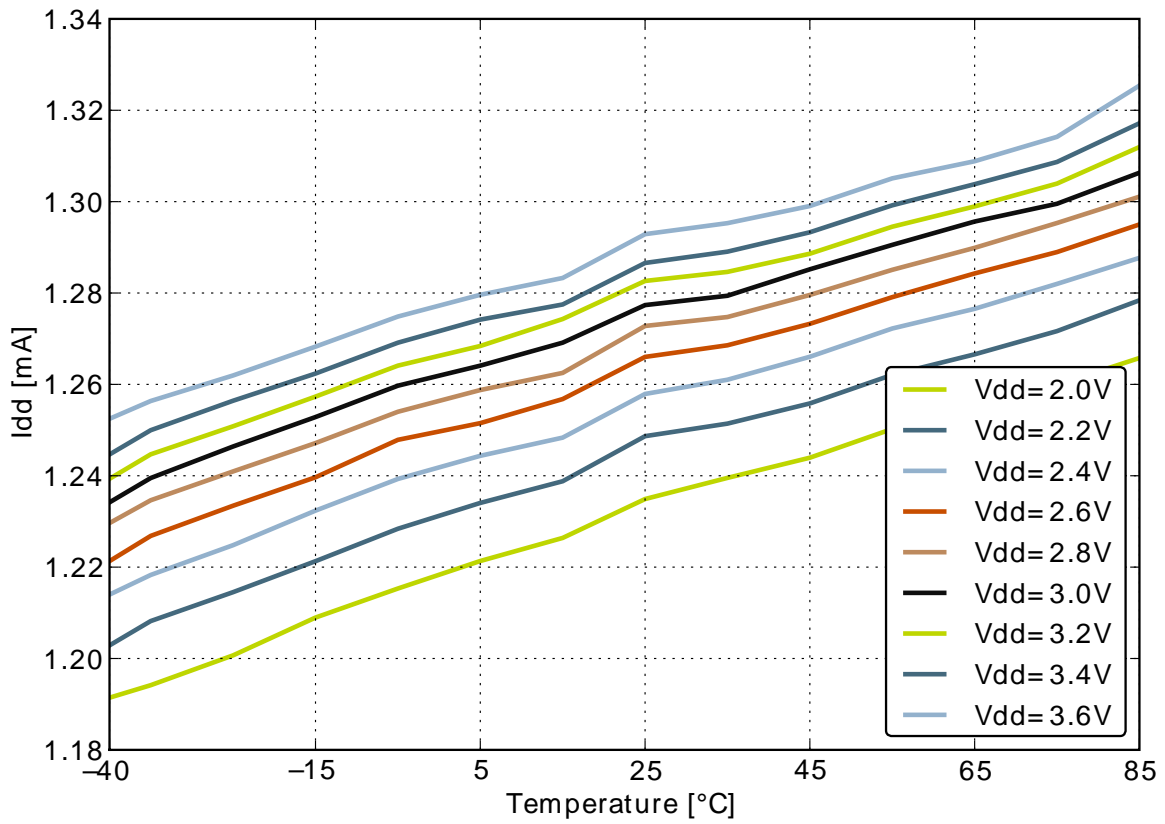

Figure 3.5. EM2 Current consumption vs supply voltage

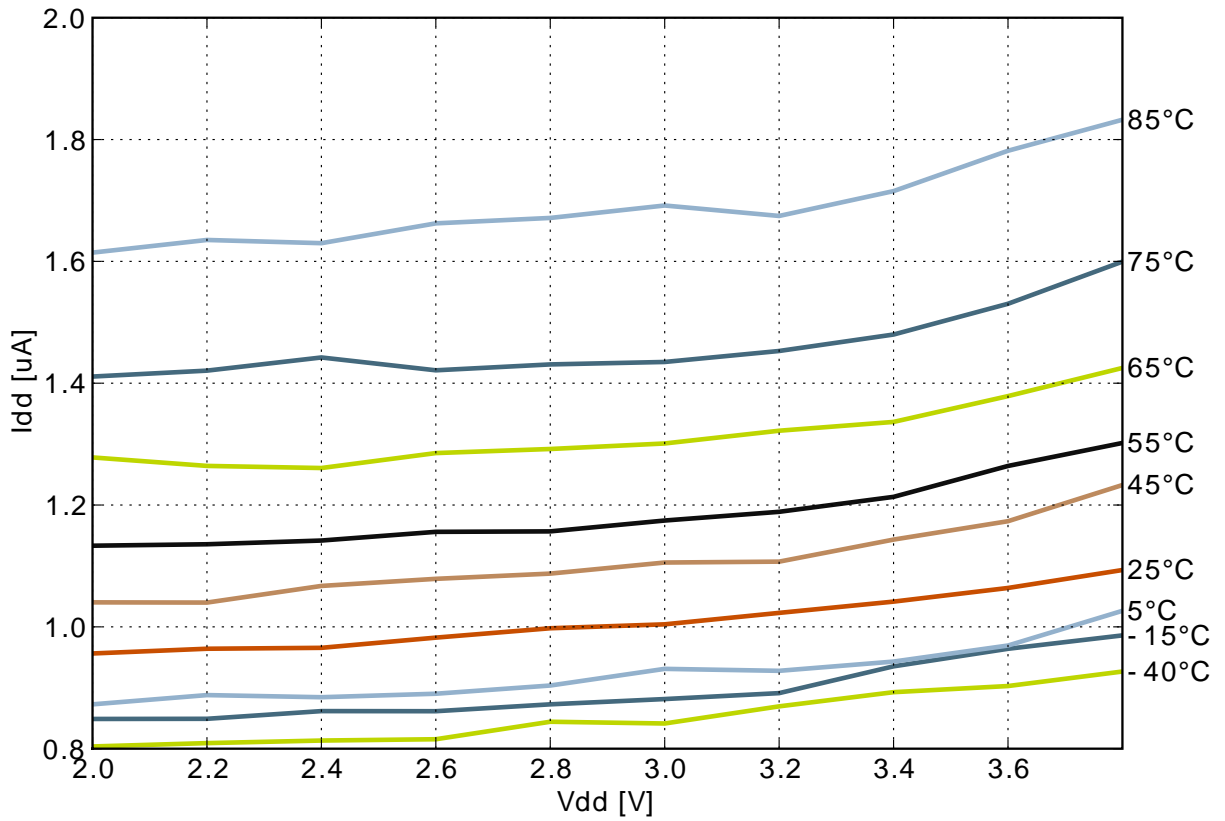

Figure 3.6. EM2 Current consumption vs temperature

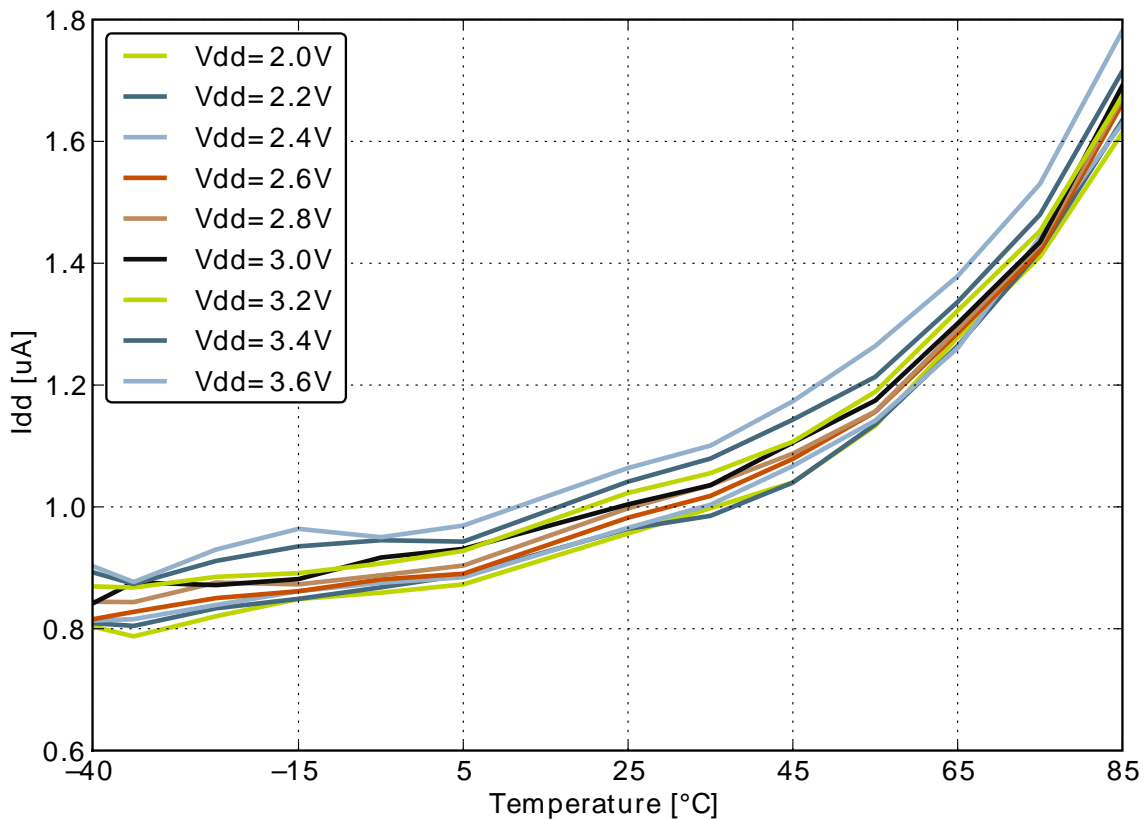

Figure 3.7. EM3 Current consumption vs supply voltage

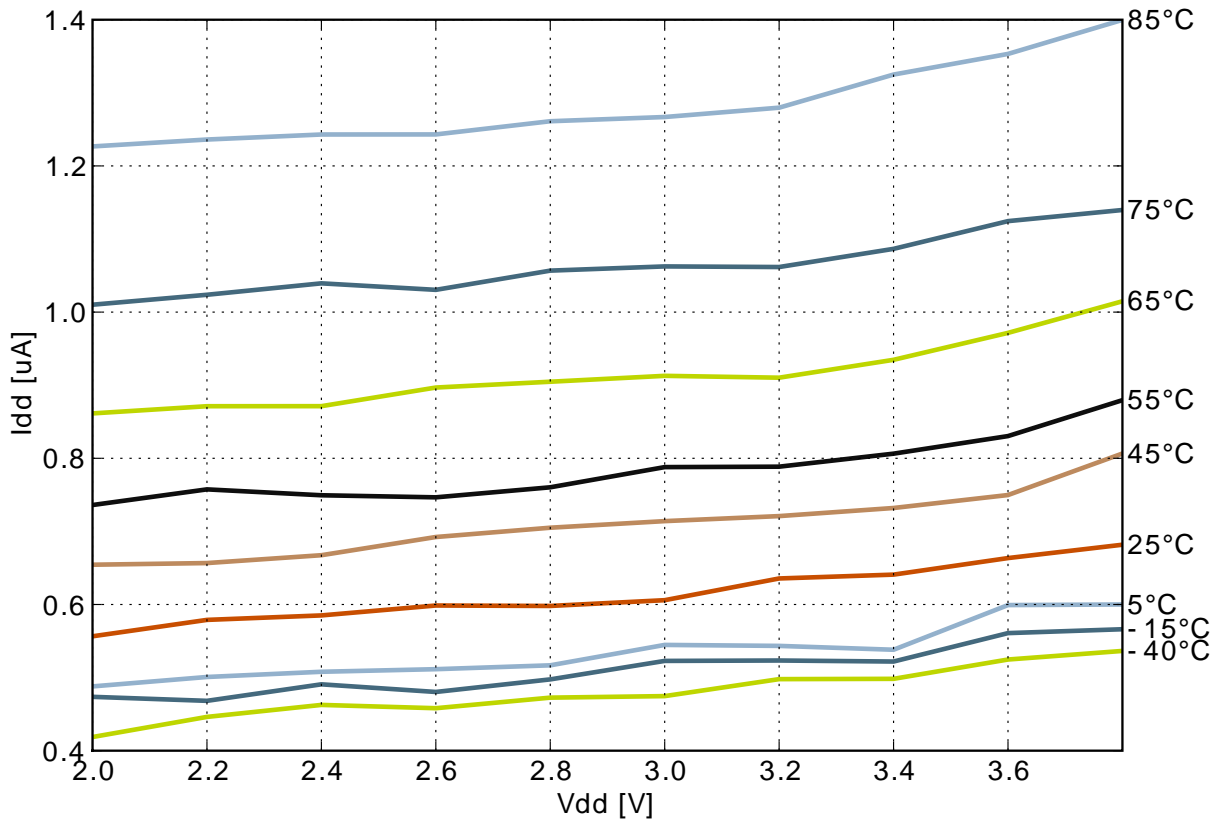

Figure 3.8. EM3 Current consumption vs temperature

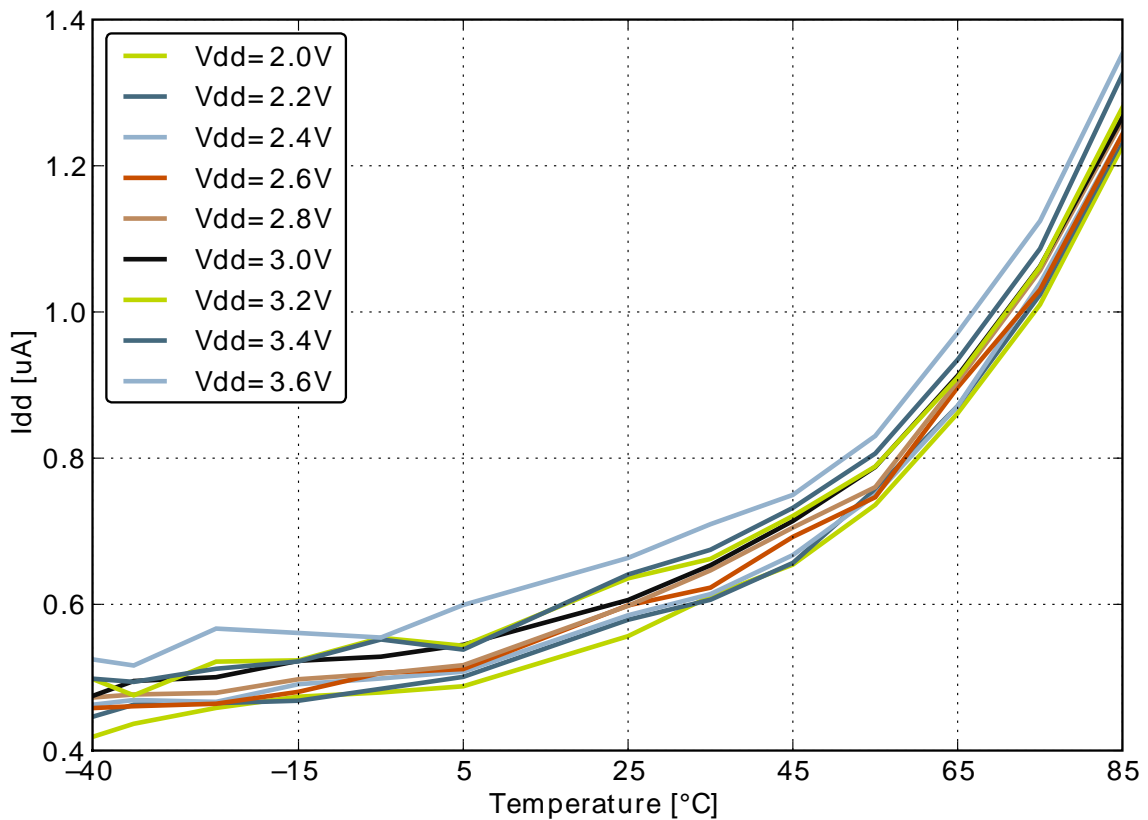

Figure 3.9. EM4 Current consumption vs supply voltage

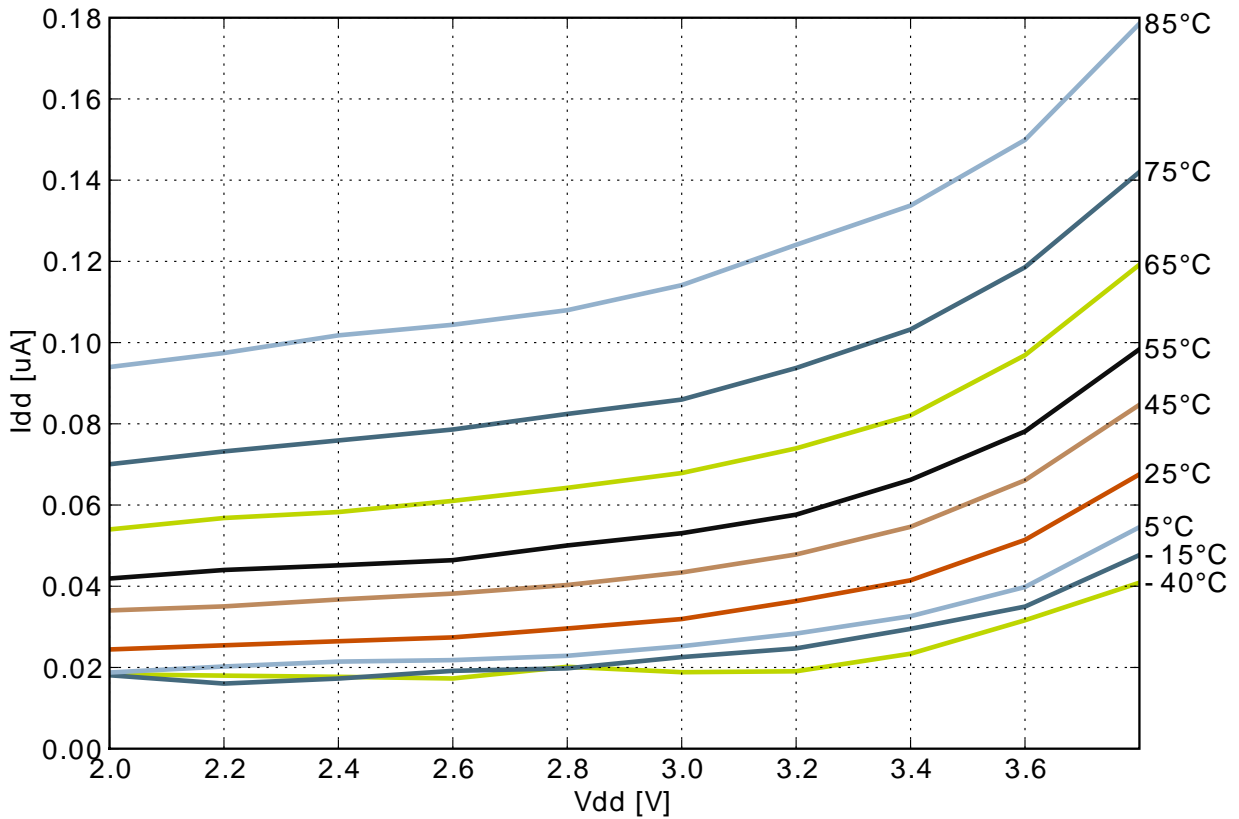
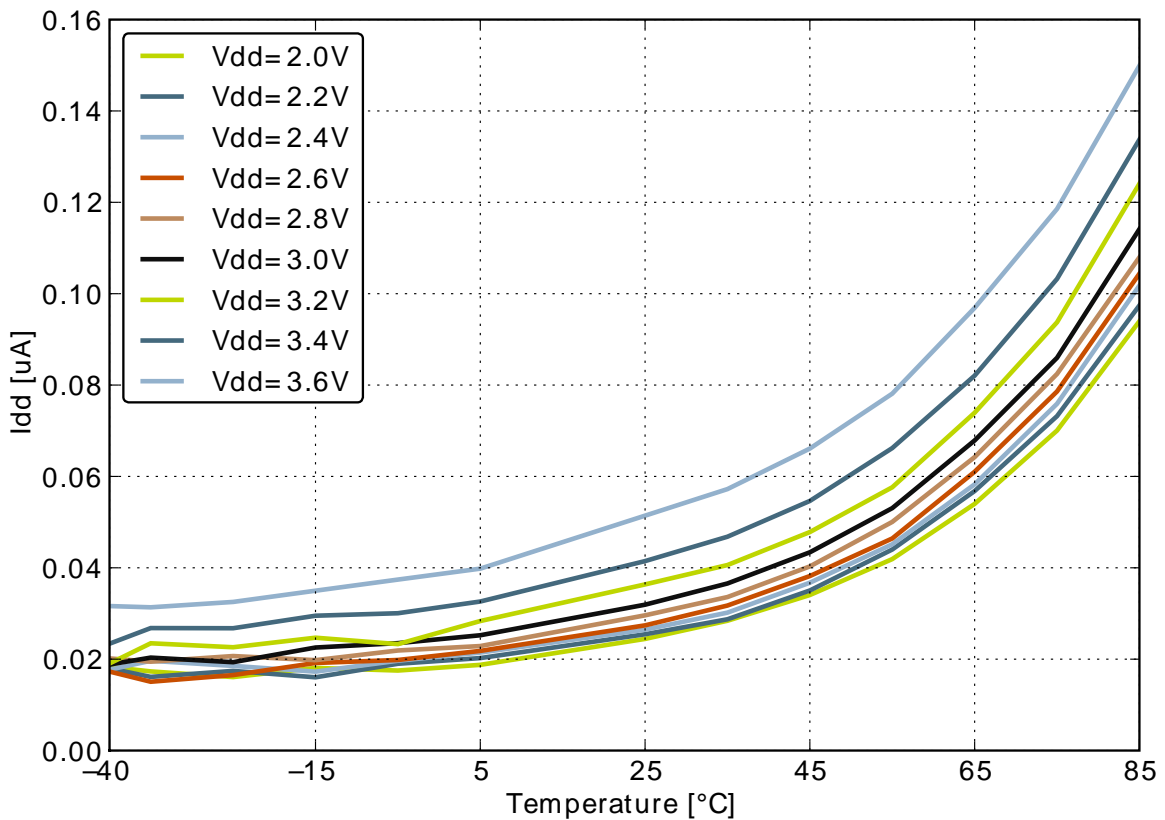

Figure 3.10. EM4 Current consumption vs temperature





## 3.5 Transition between Energy Modes

**Table 3.5. Energy Modes Transitions**

Symbol	Parameter	Condition	Min	Typ	Max	Unit
$t_{EM10}$	Transition time from EM1 to EM0			0 <sup>1</sup>		HF core CLK cycles
$t_{EM20}$	Transition time from EM2 to EM0			2		$\mu$ s
$t_{EM30}$	Transition time from EM3 to EM0			2		$\mu$ s
$t_{EM40}$	Transition time from EM4 to EM0			163		$\mu$ s

<sup>1</sup>Core wakeup time only.

## 3.6 Power Management

**Table 3.6. Power Management**

Symbol	Parameter	Condition	Min	Typ	Max	Unit
$V_{BODextthr-}$	BOD threshold on falling external supply voltage		1.77		1.80	V
$V_{BODintthr-}$	BOD threshold on falling internally regulated supply voltage		1.62		1.65	V
$V_{BODextthr+}$	BOD threshold on rising external supply voltage	Uncalibrated		1.82		V
$V_{BODexthyst}$	BOD hysteresis on external supply voltage			150		mV
$TC_{BGR}$	Temperature coefficient of band-gap reference (BGR)	Relative voltage variation in EM0 based on the difference in $V_{ref}$ between -40°C and 85°C.			0.55	%
$t_{RESET}$	Delay from reset is released until program execution starts	Applies to Power-on Reset, Brown-out Reset and pin reset.		163		$\mu$ s
$C_{DECOUPLE}$	Voltage regulator decoupling capacitor.	X5R capacitor recommended. Apply between DECOUPLE pin and GROUND		1		$\mu$ F

## 3.7 Flash

**Table 3.7. Flash**

Symbol	Parameter	Condition	Min	Typ	Max	Unit
EC <sub>FLASH</sub>	Flash erase cycles before failure		20000			cycles
RET <sub>FLASH</sub>	Flash data retention	T <sub>AMB</sub> <85°C	10			years
t <sub>W_PROG</sub>	Word (32-bit) programming time		20			µs
t <sub>P_ERASE</sub>	Page erase time		20	20.4	20.8	ms
t <sub>D_ERASE</sub>	Device erase time		40	40.8	41.6	ms

## 3.8 General Purpose Input Output

**Table 3.8. GPIO**

Symbol	Parameter	Condition	Min	Typ	Max	Unit
V <sub>IOIL</sub>	Input low voltage				0.3V <sub>DD</sub>	V
V <sub>IOIH</sub>	Input high voltage		0.7V <sub>DD</sub>			V
V <sub>IOOH</sub>	Output high voltage relative to V <sub>DD</sub>	Sourcing 6 mA, V <sub>DD</sub> =1.8V	75			%
		Sourcing 6 mA, V <sub>DD</sub> =3.0V	95			%
		Sourcing 20 mA, V <sub>DD</sub> =1.8V	70			%
		Sourcing 20 mA, V <sub>DD</sub> =3.0V	90			%
V <sub>IOOL</sub>	Output low voltage relative to V <sub>DD</sub>	Sinking 6 mA, V <sub>DD</sub> =1.8V			25	%
		Sinking 6 mA, V <sub>DD</sub> =3.0V			5	%
		Sinking 20 mA, V <sub>DD</sub> =1.8V			30	%
		Sinking 20 mA, V <sub>DD</sub> =3.0V			10	%
R <sub>PU</sub>	I/O pin pull-up resistor			40		kOhm
R <sub>PD</sub>	I/O pin pull-down resistor			40		kOhm
R <sub>IOESD</sub>	Internal ESD series resistor			200		Ohm
t <sub>IOGLITCH</sub>	Pulse width of pulses to be removed by the glitch suppression filter		10		50	ns
t <sub>IOOF</sub>	Output fall time	0.5 mA drive strength and load capacitance C <sub>L</sub> =12.5-25pF.	20+0.1C <sub>L</sub>		250	ns
		2mA drive strength and load capacitance C <sub>L</sub> =350-600pF	20+0.1C <sub>L</sub>		250	ns
V <sub>IOHYST</sub>	I/O pin hysteresis (V <sub>IOTHR+</sub> - V <sub>IOTHR-</sub> )	V <sub>DD</sub> = 1.8 - 3.8 V	0.1V <sub>DD</sub>			V

## 3.9 Oscillators

### 3.9.1 LFXO

**Table 3.9. LFXO**

Symbol	Parameter	Condition	Min	Typ	Max	Unit
$f_{LFXO}$	Crystal frequency			32.768		kHz
$ESR_{LFXO}$	Supported crystal equivalent series resistance (ESR)			30	120	kOhm
$C_{LFXOL}$	Supported crystal external load range		5		25	pF
$DC_{LFXO}$	Duty cycle		48	50	53.5	%
$I_{LFXO}$	Current consumption for core and buffer after start-up.	ESR=30 kOhm, $C_L=10$ pF, LFXOBOOST in CMU_CTRL is 1		190		nA
$t_{LFXO}$	Start-up time.	ESR=30 kOhm, $C_L=10$ pF, 40% - 60% duty cycle has been reached, LFXOBOOST in CMU_CTRL is 1		400		ms

### 3.9.2 HFXO

**Table 3.10. HFXO**

Symbol	Parameter	Condition	Min	Typ	Max	Unit
$f_{HFXO}$	Crystal Frequency		4		32	MHz
$ESR_{HFXO}$	Supported crystal equivalent series resistance (ESR)	Crystal frequency 32 MHz		30	60	Ohm
		Crystal frequency 4 MHz		400	1500	Ohm
$g_{mHFXO}$	The transconductance of the HFXO input transistor at crystal startup	HFXOBOOST in CMU_CTRL equals 0b11	20			mS
$C_{HFXOL}$	Supported crystal external load range		5		25	pF
$DC_{HFXO}$	Duty cycle		46	50	54	%
$I_{HFXO}$	Current consumption for HFXO after startup	4 MHz: ESR=400 Ohm, $C_L=20$ pF, HFXOBOOST in CMU_CTRL equals 0b11		85		$\mu$ A
		32 MHz: ESR=30 Ohm, $C_L=10$ pF, HFXOBOOST in CMU_CTRL equals 0b11		165		$\mu$ A
$t_{HFXO}$	Startup time	32 MHz: ESR=30 Ohm, $C_L=10$ pF, HFXOBOOST in CMU_CTRL equals 0b11		400		$\mu$ s

### 3.9.3 LFRCO

Table 3.11. LFRCO

Symbol	Parameter	Condition	Min	Typ	Max	Unit
$t_{LFRCO}$	Startup time not including software calibration			150		$\mu$ s
$I_{LFRCO}$	Current consumption			190		nA

### 3.9.4 HFRCO

Table 3.12. HFRCO

Symbol	Parameter	Condition	Min	Typ	Max	Unit
$f_{HFRCO}$	Oscillation frequency	28 MHz frequency band		28		MHz
		21 MHz frequency band		21		MHz
		14 MHz frequency band		14		MHz
		11 MHz frequency band		11		MHz
		7 MHz frequency band		7		MHz
		1 MHz frequency band		1		MHz
$t_{HFRCO}$	Start-up time not including software calibration	$f_{HFRCO} = 14$ MHz		0.6		$\mu$ s
$I_{HFRCO}$	Current consumption	$f_{HFRCO} = 28$ MHz		106		$\mu$ A
		$f_{HFRCO} = 21$ MHz		93		$\mu$ A
		$f_{HFRCO} = 14$ MHz		77		$\mu$ A
		$f_{HFRCO} = 11$ MHz		72		$\mu$ A
		$f_{HFRCO} = 7$ MHz		63		$\mu$ A
$DC_{HFRCO}$	Duty cycle	$f_{HFRCO} = 14$ MHz	48.5	50	51	%

## 3.10 Analog Digital Converter (ADC)

Table 3.13. ADC

Symbol	Parameter	Condition	Min	Typ	Max	Unit
$V_{ADCCM}$	Analog input common mode voltage range		0		$V_{DD}$	V
$V_{ADCIN}$	Input voltage range of external reference voltage, single ended and differential		1.25		$V_{DD}$	V
$I_{ADC}$	Average active current	1 MSamples/s, 12 bit, external reference		220		$\mu$ A
		10 kSamples/s 12 bit, internal 1.25 V reference, WARMUP-MODE in ADCn_CTRL set to 0b00		9		$\mu$ A
		10 kSamples/s 12 bit, internal 1.25 V reference, WARMUP-MODE in ADCn_CTRL set to 0b01		6		$\mu$ A

Symbol	Parameter	Condition	Min	Typ	Max	Unit
		10 kSamples/s 12 bit, internal 1.25 V reference, WARMUP-MODE in ADCn_CTRL set to 0b10		74		μA
		10 kSamples/s 12 bit, internal 1.25 V reference, WARMUP-MODE in ADCn_CTRL set to 0b11		290		μA
		6 bit 10 kSamples/s, internal 1.25 V reference, WARMUP-MODE in ADCn_CTRL set to 0b01		4		μA
I <sub>ADCREF</sub>	Current consumption of internal voltage reference	Internal voltage reference		70		μA
C <sub>ADCIN</sub>	Input capacitance			2		pF
R <sub>ADCIN</sub>	Input ON resistance		1			MΩ
V <sub>ADCCMOUT</sub>	Common mode output voltage range			1.65		V
f <sub>ADCCLK</sub>	Frequency of ADC clock, max and min			13		MHz
t <sub>ADCCONV</sub>	Conversion time			1		μs
t <sub>ADCACQ</sub>	Acquisition time	Programmable		0.5		μs
t <sub>ADCACQVDD3</sub>	Required sample time for VDD/3 reference			2		μs
t <sub>ADCSTART</sub>	Startup time of reference generator in NORMAL mode and startup time ADC			5		μs
	Startup time of reference generator in KEEPAD-CWARM mode and startup time ADC			1		μs
SNR <sub>ADC</sub>	Signal to Noise Ratio (SNR)	1 MSamples/s, 12 bit, single ended, internal 1.25V reference		69		dB
		1 MSamples/s, 12 bit, single ended, internal 2.5V reference		72		dB
		1 MSamples/s, 12 bit, differential, internal 1.25V reference		70		dB
		1 MSamples/s, 12 bit, differential, internal 2.5V reference		73		dB
		1 MSamples/s, 12 bit, differential, 5V reference		73		dB
		100 kSamples/s, 12 bit, single ended, internal 1.25V reference		69		dB
		100 kSamples/s, 12 bit, single ended, internal 2.5V reference		72		dB

Symbol	Parameter	Condition	Min	Typ	Max	Unit
		100 kSamples/s, 12 bit, differential, internal 1.25V reference		70		dB
		100 kSamples/s, 12 bit, differential, internal 2.5V reference		73		dB
		100 kSamples/s, 12 bit, differential, 5V reference		73		dB
		1.86 MSamples/s, 6 bit, single ended, internal 1.25V reference		37		dB
SNDR <sub>ADC</sub>	Signal to Noise-puls-Distortion Ratio (SNDR)	1 MSamples/s, 12 bit, single ended, internal 1.25V reference		68		dB
		1 MSamples/s, 12 bit, single ended, internal 2.5V reference		71		dB
		1 MSamples/s, 12 bit, differential, internal 1.25V reference		69		dB
		1 MSamples/s, 12 bit, differential, internal 2.5V reference		72		dB
		1 MSamples/s, 12 bit, differential, 5V reference		72		dB
		100 kSamples/s, 12 bit, single ended, internal 1.25V reference		68		dB
		100 kSamples/s, 12 bit, single ended, internal 2.5V reference		71		dB
		100 kSamples/s, 12 bit, differential, internal 1.25V reference		69		dB
		100 kSamples/s, 12 bit, differential, internal 2.5V reference		72		dB
		100 kSamples/s, 12 bit, differential, 5V reference		72		dB
		1.86 MSamples/s, 6 bit, single ended, internal 1.25V reference		37		dB
SFDR <sub>ADC</sub>	Spurious-Free Dynamic Range (SFDR)	1 MSamples/s, 12 bit, single ended, internal 1.25V reference		75		dB
		1 MSamples/s, 12 bit, single ended, internal 2.5V reference		75		dB
		1 MSamples/s, 12 bit, differential, internal 1.25V reference		75		dB
		1 MSamples/s, 12 bit, differential, internal 2.5V reference		75		dB

Symbol	Parameter	Condition	Min	Typ	Max	Unit
		1 MSamples/s, 12 bit, differential, 5V reference		75		dB
		100 kSamples/s, 12 bit, single ended, internal 1.25V reference		75		dB
		100 kSamples/s, 12 bit, single ended, internal 2.5V reference		75		dB
		100 kSamples/s, 12 bit, differential, internal 1.25V reference		75		dB
		100 kSamples/s, 12 bit, differential, internal 2.5V reference		75		dB
		100 kSamples/s, 12 bit, differential, 5V reference		75		dB
		1.86 MSamples/s, 6 bit, single ended, internal 1.25V reference		57		dB
V <sub>ADCOFFSET</sub>	Offset voltage	Before calibration, single ended		10		mV
		After calibration, single ended		0.3		mV
		Before calibration, differential		10		mV
		After calibration, differential		0.3		mV
DNL <sub>ADC</sub>	Differential non-linearity (DNL)	Internal 1.25V reference		1		LSB
		Internal 2.5V reference		1		LSB
		Internal 5V reference		1		LSB
INL <sub>ADC</sub>	Integral non-linearity (INL), End point method	Internal 1.25V reference		2		LSB
		Internal 2.5V reference		2		LSB
		Internal 5V reference		2		LSB
MC <sub>ADC</sub>	No missing codes	12 bit, internal 1.25V reference, single ended		0		
		12 bit, internal 1.25V reference, differential		0		
		12 bit, internal 2.5V reference, single ended		0		
		12 bit, internal 2.5V reference, differential		0		
		12 bit, internal 5V reference, differential		0		

The integral non-linearity (INL) and differential non-linearity parameters are explained in Figure 3.11 (p. 24) and Figure 3.12 (p. 24) , respectively.

Figure 3.11. Integral Non-Linearity (INL)

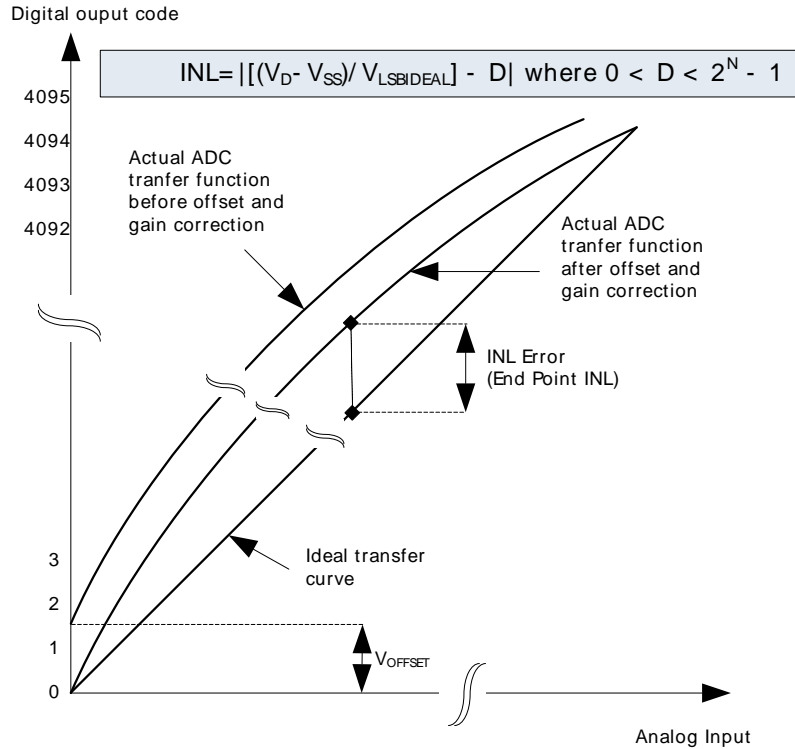
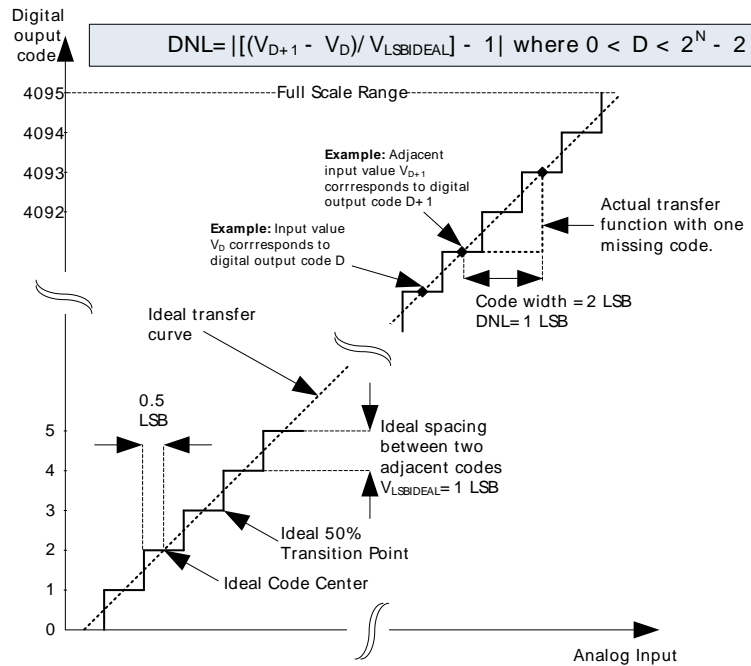

Figure 3.12. Differential Non-Linearity (DNL)



### 3.11 Digital Analog Converter (DAC)

Table 3.14. DAC

Symbol	Parameter	Condition	Min	Typ	Max	Unit
$V_{DACOUT}$	Output voltage range	External voltage reference, single ended	0		$V_{DD}$	V
$V_{DACCM}$	Output common mode voltage range		0		$V_{DD}$	V



Symbol	Parameter	Condition	Min	Typ	Max	Unit
I <sub>DAC</sub>	Active current including references for 2 channels	500 kSamples/s, 12bit		400		μA
		100 kSamples/s, 12 bit		200		μA
		1 kSamples/s 12 bit NORMAL		38		μA
f <sub>DAC</sub>	DAC clock frequency			0.5		MHz
t <sub>DACCONV</sub>	DAC conversion time			2		μs
t <sub>DACSETTLE</sub>	DAC settling time			5		μs
SNR <sub>DAC</sub>	DAC Signal to Noise Ratio (SNR)	500 kSamples/s, 12 bit, single ended, internal 1.25V reference		71		dB
		500 kSamples/s, 12 bit, single ended, internal 2.5V reference		70		dB
		100 kSamples/s, 12 bit, single ended, internal 1.25V reference		72		dB
		100 kSamples/s, 12 bit, single ended, internal 2.5V reference		71		dB
SNDR <sub>DAC</sub>	DAC Signal to Noise-pulse Distortion Ratio (SNDR)	500 kSamples/s, 12 bit, single ended, internal 1.25V reference		70		dB
		500 kSamples/s, 12 bit, single ended, internal 2.5V reference		69		dB
		100 kSamples/s, 12 bit, single ended, internal 1.25V reference		71		dB
		100 kSamples/s, 12 bit, single ended, internal 2.5V reference		70		dB
SFDR <sub>DAC</sub>	DAC Spurious-Free Dynamic Range(SFDR)	500 kSamples/s, 12 bit, single ended, internal 1.25V reference		75		dB
		500 kSamples/s, 12 bit, single ended, internal 2.5V reference		75		dB
		100 kSamples/s, 12 bit, single ended, internal 1.25V reference		75		dB
		100 kSamples/s, 12 bit, single ended, internal 2.5V reference		75		dB
V <sub>DACOFFSET</sub>	Offset voltage	Before calibration, single ended		10		mV
		After calibration, single ended		0.5		mV
DNL <sub>DAC</sub>	Differential non-linearity	Internal 1.25V reference		1		LSB
		Internal 2.5V reference		1		LSB
INL <sub>DAC</sub>	Integral non-linearity	Internal 1.25V reference		2		LSB

Symbol	Parameter	Condition	Min	Typ	Max	Unit
		Internal 2.5V reference		2		LSB
MC <sub>DAC</sub>	No missing codes	12 bit, internal 1.25V reference, single ended		0		
		12 bit, internal 2.5V reference, single ended		0		

### 3.12 Analog Comparator (ACMP)

Table 3.15. ACMP

Symbol	Parameter	Condition	Min	Typ	Max	Unit
V <sub>ACMPIN</sub>	Input voltage range		0		V <sub>DD</sub>	V
V <sub>ACMPCM</sub>	ACMP Common Mode voltage range		0		V <sub>DD</sub>	V
I <sub>ACMP</sub>	Active current	BIASPROG=0b0000, FULL-BIAS=0 and HALFBIAS=1 in ACMPn_CTRL register		0.1		μA
		BIASPROG=0b1111, FULL-BIAS=0 and HALFBIAS=0 in ACMPn_CTRL register		2.87		μA
		BIASPROG=0b1111, FULL-BIAS=1 and HALFBIAS=0 in ACMPn_CTRL register		195		μA
I <sub>ACMPREF</sub>	Current consumption of internal voltage reference	Internal voltage reference off. Using external voltage reference		0		μA
		Internal voltage reference		5		μA
V <sub>ACMPOFFSET</sub>	Offset voltage	Single ended		10		mV
		Differential		10		mV
V <sub>ACMPHYST</sub>	ACMP hysteresis	Programmable		17		mV
R <sub>CSRES</sub>	Capacitive Sense Internal Resistance	CSRESSEL=0b00 in ACMPn_INPUTSEL		39		kOhm
		CSRESSEL=0b01 in ACMPn_INPUTSEL		71		kOhm
		CSRESSEL=0b10 in ACMPn_INPUTSEL		104		kOhm
		CSRESSEL=0b11 in ACMPn_INPUTSEL		136		kOhm

The total ACMP current is the sum of the contributions from the ACMP and its internal voltage reference as given in Equation 3.1 (p. 26) . I<sub>ACMPREF</sub> is zero if an external voltage reference is used.

#### Total ACMP Active Current

$$I_{ACMPTOTAL} = I_{ACMP} + I_{ACMPREF} \tag{3.1}$$

## 3.13 Voltage Comparator (VCMP)

**Table 3.16. VCMP**

Symbol	Parameter	Condition	Min	Typ	Max	Unit
V <sub>VCMPIN</sub>	Input voltage range			V <sub>DD</sub>		V
V <sub>VCMP<sub>CM</sub></sub>	VCMP Common Mode voltage range			V <sub>DD</sub>		V
I <sub>VCMP</sub>	Active current	BIASPROG=0b0000 and HALFBIAS=1 in VCMPn_CTRL register		0.1		μA
		BIASPROG=0b1111 and HALFBIAS=0 in VCMPn_CTRL register		2.7		μA
t <sub>VCMPREF</sub>	Startup time reference generator	NORMAL		10		μs
V <sub>VCMP<sub>OFFSET</sub></sub>	Offset voltage	Single ended		10		mV
		Differential		10		mV
V <sub>VCMP<sub>HYST</sub></sub>	VCMP hysteresis			17		mV

The V<sub>DD</sub> trigger level can be configured by setting the TRIGLEVEL field of the VCMP\_CTRL register in accordance with the following equation:

### VCMP Trigger Level as a Function of Level Setting

$$V_{DD \text{ Trigger Level}} = 1.667V + 0.034 \times \text{TRIGLEVEL} \quad (3.2)$$

## 3.14 Digital Peripherals

**Table 3.17. Digital Peripherals**

Symbol	Parameter	Condition	Min	Typ	Max	Unit
I <sub>USART</sub>	USART current	USART idle current, clock enabled		TBD		μA/MHz
		USART transmit current		TBD		μA/MHz
I <sub>UART</sub>	UART current	UART idle current, clock enabled		TBD		μA/MHz
		UART transmit current		TBD		μA/MHz
I <sub>LEUART</sub>	LEUART current	LEUART idle current, clock enabled		TBD		μA
		LEUART transmit current		TBD		μA
I <sub>I2C</sub>	I2C current	I2C idle current, clock enabled		TBD		μA/MHz
		I2C transmit current		TBD		μA/MHz
I <sub>TIMER</sub>	TIMER current	TIMER_0 idle current, clock enabled		TBD		μA/MHz
		TIMER_n (n>0) idle current, clock enabled		TBD		μA/MHz

Symbol	Parameter	Condition	Min	Typ	Max	Unit
		TIMER counting current, counter enabled		TBD		μA/ MHz
I <sub>LETIMER</sub>	LETIMER current	LETIMER idle current, clock enabled		TBD		μA
		LETIMER counting current, counter enabled		TBD		μA
I <sub>PCNT</sub>	PCNT current	PCNT idle current, clock enabled		TBD		μA
		PCNT Count Current, counter enabled		TBD		μA
I <sub>RTC</sub>	RTC current	RTC idle current, clock enabled		TBD		μA
		RTC counting current, counter enabled		TBD		μA
I <sub>WDOG</sub>	WDOG current	WDOG idle current, clock enabled		TBD		μA
		WDOG counting current, counter enabled		TBD		μA
I <sub>AES</sub>	AES current	AES idle current, clock enabled		TBD		μA/ MHz
		AES-128 encryption/decryption current		TBD		μA/ MHz
		AES-256 encryption/decryption current		TBD		μA/ MHz
I <sub>EBI</sub>	EBI current	EBI idle current, clock enabled		TBD		μA/ MHz
I <sub>PRS</sub>	PRS current	PRS idle current		TBD		μA/ MHz
I <sub>DMA</sub>	DMA current	Clock enable		TBD		μA/ MHz

# 4 Pinout and Package

## 4.1 Pinout

The EFM32G210 pinout is shown in Table 4.1 (p. 29). Alternate locations are denoted by "#" followed by the location number (Multiple locations on the same pin are split with "/"). Alternate locations can be configured in the LOCATION bitfield in the \*\_ROUTE register in the module in question.

**Table 4.1. Device Pinout**

QFN32 Pin# and Name		Pin Functionality								
Pin #	Pin Name	Analog	Debug	EBI	Timers			Communication		Other
0	VSS	-	-	-	-	-	-	-	-	-
1	PA0	-	-	-	TIM0_CC0 #0/1	-	-	I2C0_SDA #0	-	-
2	PA1	-	-	-	TIM0_CC1 #0/1	-	-	I2C0_SCL #0	-	CMU_OUT1 #0
3	PA2	-	-	-	TIM0_CC2 #0/1	-	-	-	-	CMU_OUT0 #0
4	IOVDD_1	-	-	-	-	-	-	-	-	-
5	PC0	ACMP0_CH0	-	-	PCNT0_S0IN #2	-	-	US1_TX #0	-	-
6	PC1	ACMP0_CH1	-	-	PCNT0_S1IN #2	-	-	US1_RX #0	-	-
7	PB7	LFXTAL_P	-	-	-	-	-	US1_CLK #0	-	-
8	PB8	LFXTAL_N	-	-	-	-	-	US1_CS #0	-	-
9	RESETn	-	-	-	-	-	-	-	-	-
10	PB11	DAC0_OUT0	-	-	LETIM0_OUT0 #1	-	-	-	-	-
11	AVDD_2	-	-	-	-	-	-	-	-	-
12	PB13	HFX TAL_P	-	-	-	-	-	LEU0_TX #1	-	-
13	PB14	HFX TAL_N	-	-	-	-	-	LEU0_RX #1	-	-
14	IOVDD_3	-	-	-	-	-	-	-	-	-
15	AVDD_0	-	-	-	-	-	-	-	-	-
16	PD4	ADC0_CH4	-	-	-	-	-	LEU0_TX #0	-	-
17	PD5	ADC0_CH5	-	-	-	-	-	LEU0_RX #0	-	-
18	PD6	ADC0_CH6	-	-	LETIM0_OUT0 #0	-	-	I2C0_SDA #1	-	-
19	PD7	ADC0_CH7	-	-	LETIM0_OUT1 #0	-	-	I2C0_SCL #1	-	-
20	VDD_DREG	-	-	-	-	-	-	-	-	-
21	DECOUPLE	-	-	-	-	-	-	-	-	-
22	PC13	ACMP1_CH5	-	-	TIM0_CDTI0 #1/3	TIM1_CC0 #0	PCNT0_S0IN #0	-	-	-
23	PC14	ACMP1_CH6	-	-	TIM0_CDTI1 #1/3	TIM1_CC1 #0	PCNT0_S1IN #0	-	-	-

QFN32 Pin# and Name		Pin Functionality								
Pin #	Pin Name	Analog	Debug	EBI	Timers			Communication		Other
24	PC15	ACMP1_CH7	DBG_SWV #1	-	TIM0_CDTI2 #1/3	TIM1_CC2 #0	-	-	-	-
25	PF0	-	DBG_SWCLK #0/1	-	LETIM0_OUT0 #2	-	-	-	-	-
26	PF1	-	DBG_SWDIO #0/1	-	LETIM0_OUT1 #2	-	-	-	-	-
27	PF2	-	DBG_SWV #0	-	-	-	-	-	-	ACMP1_O #0
28	IOVDD_5	-	-	-	-	-	-	-	-	-
29	PE10	-	-	-	TIM1_CC0 #1	-	-	US0_TX #0	-	-
30	PE11	-	-	-	TIM1_CC1 #1	-	-	US0_RX #0	-	-
31	PE12	-	-	-	TIM1_CC2 #1	-	-	US0_CLK #0	-	-
32	PE13	-	-	-	-	-	-	US0_CS #0	-	ACMP0_O #0

## 4.2 GPIO pinout overview

The specific GPIO pins available in *EFM32G210* is shown in Table 4.2 (p. 30). Each GPIO port is organized as 16-bit ports indicated by letters A through F, and the individual pin on this port is indicated by a number from 15 down to 0.

**Table 4.2. GPIO Pinout**

Port	Pin 15	Pin 14	Pin 13	Pin 12	Pin 11	Pin 10	Pin 9	Pin 8	Pin 7	Pin 6	Pin 5	Pin 4	Pin 3	Pin 2	Pin 1	Pin 0
Port A	-	-	-	-	-	-	-	-	-	-	-	-	-	PA2	PA1	PA0
Port B	-	PB14	PB13	-	PB11	-	-	PB8	PB7	-	-	-	-	-	-	-
Port C	PC15	PC14	PC13	-	-	-	-	-	-	-	-	-	-	-	PC1	PC0
Port D	-	-	-	-	-	-	-	-	PD7	PD6	PD5	PD4	-	-	-	-
Port E	-	-	PE13	PE12	PE11	PE10	-	-	-	-	-	-	-	-	-	-
Port F	-	-	-	-	-	-	-	-	-	-	-	-	-	PF2	PF1	PF0

### 4.3 QFN32 Package

Figure 4.1. QFN32

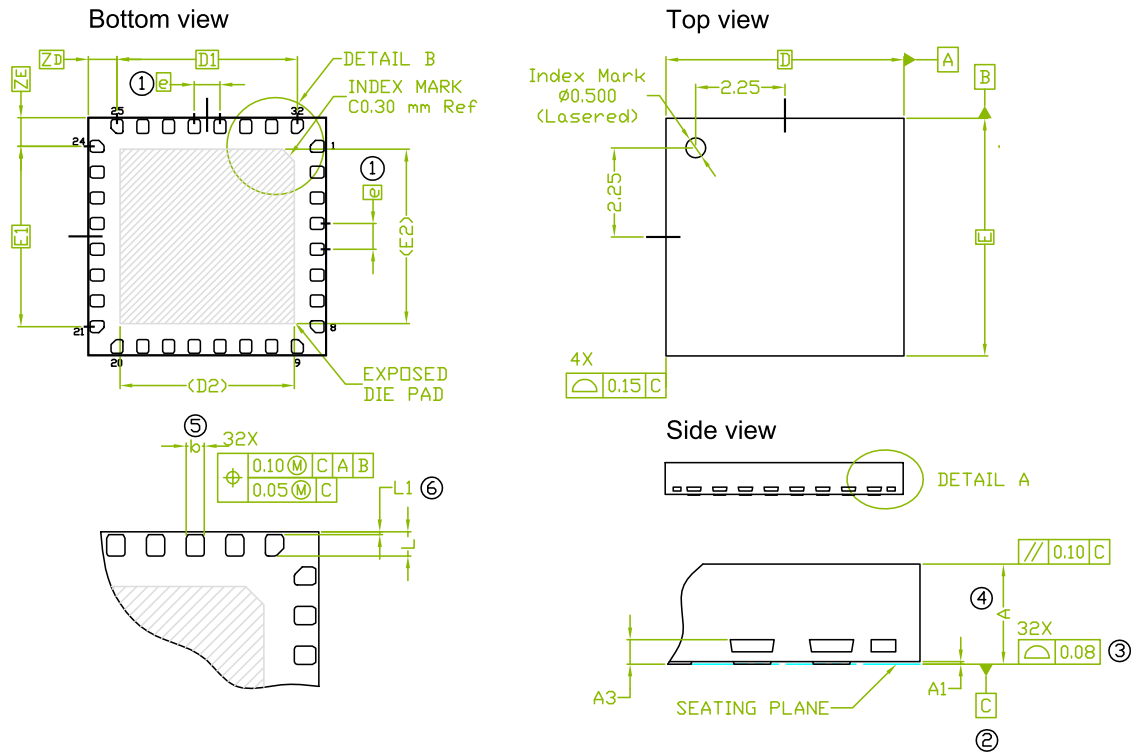

Rev: P-VQ-66-32-1A\_0901B-r0

Note:

1. 'e' represents the basic terminal pitch. Specifies the true geometric position of the terminal axis.
2. Datum 'C' is the mounting surface with which the package is in contact
3. Specifies the vertical shift of the flat part of each terminal from the mounting surface.
4. Dimension 'A' includes package warpage.
5. Dimension 'b' applies to metallized terminal and is measured between 0.15 mm and 0.30 mm from the terminal tip. If the terminal has the optional radius on the other end of the terminal, the dimension 'b' should not be measured in the radius area.
6. Depending on the method of lead termination at the edge of the package, a maximum 0.15 mm pull back (L1) may be present. 'L' minus 'L1' is to be equal to or greater than 0.3 mm.
7. Package dimensions take reference from JEDEC MO-220 rev. K, variations VJJ-2, except D2 and E2.

Table 4.3. QFN32 (Dimensions in mm)

Symbol	A	A1	A3	D	D1	E	E1	e	L1	ZD	ZE	b	L	D2	E2
Min	-	0.00							0.03			0.25	0.30	4.30	4.30
Nom	0.80	0.02	0.20	6.00	4.55	6.00	4.55	0.65	-	0.725	0.725	0.30	0.40	4.40	4.40
Max	0.90	0.05							0.15			0.35	0.50	4.50	4.50

## 5 Errata

### 5.1 Introduction

This chapter describes the identified errata of the device including fixes and workarounds for these.

### 5.2 Device revision A

#### 5.2.1 BOD threshold too high

##### Problem

The Brown-Out Detector (BOD) threshold voltage is calibrated to a too high value.

##### Effect

The high BOD threshold voltage may create sporadic BOD resets while the EFM32 is running in Energy Mode 2. Also, the BOD may cause a reset at higher voltages than specified as the threshold voltage in the Electrical Characteristics.

##### Fix/Workaround

Download Development Kit Board Support Library and Example Code (rev 1.1.1 or later) and include `chip.h` in your project. In the start of the application code, call `void_CHIP_init(void);`. This procedure will re-program the device to a safe BOD threshold.

This erratum will be fixed in the next device revision.

#### 5.2.2 Unpredictable Behaviour After WDOG Reset From EM2/EM3

##### Problem

When the watchdog (WDOG) triggers a reset while the EFM32 is in EM2 or EM3, the resulting behaviour is undefined.

##### Effect

After a watchdog reset from EM2/EM3, the EFM32 may go directly to hard fault or may not start at all.

##### Fix/Workaround

Don not use the watchdog in EM2/EM3. This is controlled by the EM2RUN and EM3RUN bits in WDOG\_CTRL. The default setting is that the Watchdog is not running in EM2/EM3.

This erratum will be fixed in the next device revision.

#### 5.2.3 Wrong RCO Frequency

##### Problem

The HFRCO, AUCHFRCO and LFRCO oscillators has wrong frequency when running with default settings.

##### Effect

The oscillator frequency has not been programmed with correct calibration values, and the frequencies are not within the expected frequency ranges.

##### Fix/Workaround



The oscillator frequency can be calibrated in the Clock Management Unit, which is described in the CMU chapter of the EFM32G Reference Manual.

This erratum will be fixed in the next device revision.

## 5.2.4 No calibration values for HFRCO band 1, 7, 11 and 21 MHz band

### Problem

The Device Information page does not contain calibration values for the 1 MHz, 7 MHz, 11 MHz and 21 MHz frequency band.

### Effect

The HFRCO frequency will be outside the expected frequency range when applying the calibration value from the device information page.

### Fix/Workaround

The oscillator frequency can be calibrated in the Clock Management Unit, which is described in the CMU chapter of the EFM32G Reference Manual.

This erratum will be fixed in the next device revision.

## 5.2.5 LFRCO/HFRCO Frequency Change during EM2/3

### Problem

RCO oscillator frequency can become unstable on transitions between EM2/3 and EM0.

### Effect

When switching between EM0 and EM2/3, the following events can happen occasionally:

- The frequency of LFRCO becomes off by up to 14%
- The frequency of HFRCO becomes off by up to 6%

The frequency will be off for a shorter or longer period.

### Fix/Workaround

Make this line of code part of your startup code, typically in the start of main():

```
*(volatile unsigned int*) 0x400C600CUL = 0x00020100;
```

As a result of this workaround, the current consumption in EM2/3 will go up by 450 nA.

This erratum will be fixed in the next device revision.

## 5.2.6 AUXHFRCO Not Automatically Disabled When Entering EM2/EM3

### Problem

AUXHFRCO is not disabled automatically when entering EM2/EM3.

### Effect

If AUXHFRCO is running while in EM2/EM3, and the EMVREG bit in EMU\_CTRL is cleared. This may result in an unstable system.

**Fix/Workaround**

Disable AUXHFRCO by writing a 1 to AUXHFRCODIS in CMU\_OSCENCMD, before going to EM2/EM3.

**5.2.7 Peripheral clocks not gated in EM2/EM3 with debug session active****Problem**

When a debug session has been active since the last reset, the EFM32 is not allowed to go to EM2 or EM3. When attempting to go to either EM2 or EM3, the system goes to EM1, and the peripheral clocks, which should have been turned off in EM2/EM3 keep going. This is only an issue when debugging a system.

**Effect**

The device cannot enter EM2/3 if a debug session has been entered since the last reset.

**Fix/Workaround**

If the debugger is running, clear HFPERCLKEN in CMU\_HFPERCLKDIV before going to EM2/EM3 and set it when going back to EM0.

**5.2.8 I<sup>2</sup>C RX Buffer Silent Overflow****Problem**

If reception of a byte by the RX shift register is completed while there is still a byte in the RX buffer, the byte in the shift register is silently discarded.

**Effect**

If a received byte is acknowledged before it is read out of the RXDATA, all new bytes received before the read operation are discarded. A new byte is not discarded if the read operation is performed before the new byte is fully received.

**Fix/Workaround**

Make sure to read the RX buffer before the reception of the next byte completes. One way to ensure this is to always read a received byte before acknowledging it.

This erratum will be fixed in the next device revision.

**5.2.9 U(S)ART Double Buffer Transmission Control****Problem**

Transmission control not working with double buffering.

**Effect**

When a frame is loaded into the transmission shift register, transmission control bits are always taken from buffer TX buffer element 1. If only one frame is in the U(S)ART buffer, the content of the buffer elements is equivalent, and transmission control bits work as specified. If two frames are in the buffer however, the control bits for the frame in buffer element 1 are used for transmitting the frame in buffer element 0. This is not a problem for frames consisting of more than 9 bits.

**Fix/Workaround**

If using transmission control bits make sure there are not more than frame in the U(S)ART buffer at a time. When TXBIL in U(S)ARTn\_CTRL is cleared, the TXBL status and interrupt flags in U(S)ARTn\_STATUS

and U(S)ARTn\_IF respectively tell when the buffer is empty. When using transmission control bits a single frame can then be loaded into the USART for transmission.

### 5.2.10 LEUART + DMA awake for last byte transmitted:

#### Problem/Effect

When using the LEUART with DMA in EM2, TXDMAWU in LEUARTn\_CTRL must be cleared when the DMA has no more data to transmit. Otherwise the LEUART will keep the system awake waiting for data from the DMA. The way to do this is to clear TXDMAWU in the DMA DONE interrupt for the channel feeding the LEUART with data. In this device revision, the DMA DONE interrupt will not trigger a wakeup from EM2. The DMA DONE interrupt is not executed before another interrupt wakes the system up from EM2.

#### Fix/Workaround

Use the TX complete interrupt (TxC) in the leuart to clear TXDMAWU, or clear TXDMAWU in the DMA DONE interrupt and make sure the TxC interrupt is triggered. The system will then be awake with a higher power consumption while the last byte is transmitted by the LEUART, but will be allowed to go back to EM2 once TXDMAWU has been cleared.

### 5.2.11 DMA Clock Disable Prevents EM2/EM3

#### Problem

When the DMA clock is disabled, the EFM32 is not able to go to Energy Modes 2 or 3.

#### Effect

The DMA will prevent the system to go to EM2/EM3 as long as the DMA clock is disabled.

#### Fix/Workaround

Make sure the DMA clock is enabled when going to EM2/EM3. The DMA clock is enabled by default, and can also be enabled in the CMU.

This erratum will be fixed in the next device revision.

### 5.2.12 ADC Temperature Sensor Not Working

#### Problem

The temperature sensor in the ADC does not work.

#### Effect

The temperature values read when sampling the temperature sensor in the ADC are not correct.

#### Fix/Workaround

Do not use the ADC temperature sensor.

This erratum will be fixed in the next device revision.

### 5.2.13 ADC SCANGAIN Affects Single Conversions

#### Problem

SCANGAIN in ADCn\_CAL affects the gain setting for single conversions.

**Effect**

When SCANGAIN and SINGLEGAIN in ADCn\_CAL have different values, single conversions will be affected by the SCANGAIN value.

**Fix/Workaround**

Configure SCANGAIN and SINGLEGAIN in ADCn\_CAL to the same value. This requires the same reference to be used for both single and scan conversions.

This erratum will be fixed in the next device revision.

## 5.2.14 ADC at 1 Msample/s does not work at default bias settings

**Problem**

The ADC does not meet its 1 Msample/s performance target for the default ADC bias settings.

**Effect**

At default ADC bias settings the ADC conversion results are wrong when running the ADC\_CLK at 13 MHz, which is required to reach the 1 Msample/s performance. Under typical conditions wrong conversions have been observed for ADC\_CLK speeds of 8 MHz and higher.

**Fix/Workaround**

Increase the ADC performance by programming increasing the ADC bias, for example by using value 0xF0F for register ADCn\_BIASPROG.

This erratum will be fixed in the next device revision.

## 5.2.15 Large spikes in ADC output when ADC output at mid code

**Problem**

The ADC does not always sample a voltage at (or close to) the middle of its range correctly (e.g. when sampling 1.25V when using the 2.5V internal reference).

**Effect**

When the ADC is sampling voltages at (or close to) the middle of its range, the ADC output code can be off by a large value (e.g. returning value 1023 or 3072 instead of the expected value of 2048). This effect happens for all ADC reference selections.

**Fix/Workaround**

Perform multiple (e.g. 3) ADC measurements for each ADC sample required and use the median value. Do not average the ADC results, throw away the 1023 or 3072 sample instead.

This erratum will be fixed in the next device revision.

## 5.2.16 DAC output voltage not correctly held in sample/hold mode

**Problem**

When the DAC is in sample/hold mode, the DAC output is not correctly held, but drifts faster than specified.

**Effect**

The DAC output starts drifting in the order of 10 mV/us after two DAC clock cycles.

#### **Fix/Workaround**

Put the DAC into continuous mode by setting the CONVMODE field in the DACn\_CTRL register to CONTINUOUS. The DAC channels will then drive their outputs continuously with the data in the DACn\_CHxDATA registers. This mode will maintain the output voltage and refresh is therefore not needed. As the DAC cores are not turned off between samples in continuous mode, the power consumption is increased compared to sample/hold mode.

### **5.2.17 DAC conversions closely after DAC channel enable are incorrect**

#### **Problem**

DAC conversions done closely after enabling the DAC channel are incorrect.

#### **Effect**

The DAC output takes about 600 us (under typical conditions) to settle after a DAC channel has been enabled via setting field CH0EN in DACn\_CH0CTRL (or CH1EN in DACn\_CH1CTRL for channel 1). The effect is most visible for the 1.25V and 2.5V internal references.

#### **Fix/Workaround**

After enabling a DAC channel, wait 600 us before programming the channel data (via DACn\_CH0DATA, DACn\_CH1DATA, or DACn\_COMBDATA).

This erratum will be fixed in the next device revision.

## 6 Revision History

### 6.1 Revision 0.83

January 25th, 2010

Updated errata in Chapter 5 (p. 32)

Specified flash word width in Section 3.7 (p. 18)

Added Capacitive Sense Internal Resistor values in Section 3.12 (p. 26) .

### 6.2 Revision 0.82

December 9th, 2009

Updated contact information.

ADC current consumption numbers updated in Section 3.10 (p. 20)

### 6.3 Revision 0.81

November 20th, 2009

Section 2.1.20 (p. 5) updated.

Section 3.1 (p. 8) updated.

Storage temperature in Section 3.2 (p. 8) updated.

Temperature coefficient of band-gap reference in Section 3.6 (p. 17) added.

Erase times in Section 3.7 (p. 18) updated.

Definitions of DNL and INL added in Figure 3.11 (p. 24) and Figure 3.12 (p. 24) .

Current consumption of digital peripherals added in Section 3.14 (p. 27) .

Updated erratas in Chapter 5 (p. 32)

### 6.4 Revision 0.80

Initial preliminary revision, October 19th, 2009

# A Disclaimer and Trademarks

## A.1 Disclaimer

*Energy Micro AS intends to provide customers with the latest, accurate, and in-depth documentation of all peripherals and modules available for system and software implementers using or intending to use the EFM32G microcontrollers. Characterization data, available modules and peripherals, memory sizes and memory addresses refer to each specific device, and “Typical” parameters provided can and do vary in different applications. Application examples described herein are for illustrative purposes only, and Energy Micro accepts no liability for inclusion and/or use in such equipment or applications resulting in personal injury, death or severe property or environmental damage. Energy Micro reserves the right to make changes without further notice and limitation to product information, specifications, and descriptions herein, and does not give warranties as to the accuracy or completeness of the included information. Energy Micro shall have no liability for the consequences of use of the information supplied herein. This document does not imply or express copyright licenses granted hereunder to design or fabricate any integrated circuits.*

## A.2 Trademark Information

Energy Micro, EFM32G, logo and combinations thereof, and others are the registered trademarks or trademarks of Energy Micro AS. ARM, CORTEX, THUMB are the registered trademarks of ARM Limited. Other terms and product names may be trademarks of others.

## B Contact Information

### B.1 Energy Micro Corporate Headquarters

Postal Address	Visitor Address	Technical Support
Energy Micro AS P.O. Box 4633 Nydalen N-0405 Oslo NORWAY	Energy Micro AS Sandakerveien 118 N-0405 Oslo NORWAY	support@energymicro.com Phone: +47 40 10 03 01

**www.energymicro.com**

Phone: +47 23 00 98 00

Fax: + 47 23 00 98 01

### B.2 Global Contacts

Visit **www.energymicro.com** for information on global distributors and representatives or contact **sales@energymicro.com** for additional information.

Americas	EMEA	APAC
Energy Micro AS P.O. Box 4633 Nydalen N-0405 Oslo NORWAY Phone: +47 23 00 98 00 Fax: + 47 23 00 98 01	Energy Micro AS P.O. Box 4633 Nydalen N-0405 Oslo NORWAY Phone: +44 (0) 7789861338 Fax: + 47 23 00 98 01	Energy Micro AS 11/F AXA Centre 151 Gloucester Road Wanchai Hong Kong Mob (China): +86 13602611177 Mob (Hong Kong): +852 90167782 Fax: + 47 23 00 98 01



## Table of Contents

1. Ordering Information .....	2
1.1. Block Diagram .....	2
2. System Summary .....	3
2.1. System Introduction .....	3
2.2. Configuration Summary .....	6
2.3. Memory Map .....	6
3. Electrical Characteristics .....	8
3.1. Test Conditions .....	8
3.2. Absolute Maximum Ratings .....	8
3.3. General Operating Conditions .....	8
3.4. Current Consumption .....	9
3.5. Transition between Energy Modes .....	17
3.6. Power Management .....	17
3.7. Flash .....	18
3.8. General Purpose Input Output .....	18
3.9. Oscillators .....	19
3.10. Analog Digital Converter (ADC) .....	20
3.11. Digital Analog Converter (DAC) .....	24
3.12. Analog Comparator (ACMP) .....	26
3.13. Voltage Comparator (VCMP) .....	27
3.14. Digital Peripherals .....	27
4. Pinout and Package .....	29
4.1. Pinout .....	29
4.2. GPIO pinout overview .....	30
4.3. QFN32 Package .....	31
5. Errata .....	32
5.1. Introduction .....	32
5.2. Device revision A .....	32
6. Revision History .....	38
6.1. Revision 0.83 .....	38
6.2. Revision 0.82 .....	38
6.3. Revision 0.81 .....	38
6.4. Revision 0.80 .....	38
A. Disclaimer and Trademarks .....	39
A.1. Disclaimer .....	39
A.2. Trademark Information .....	39
B. Contact Information .....	40
B.1. Energy Micro Corporate Headquarters .....	40
B.2. Global Contacts .....	40

## List of Figures

1.1. Block Diagram .....	2
2.1. <i>EFM32G210</i> Memory Map with largest RAM and Flash sizes .....	7
3.1. EM0 Current consumption vs supply voltage, executing code from flash with HFRCO running at 28MHz .....	10
3.2. EM0 Current consumption vs temperature, executing code from flash with HFRCO running at 28MHz .....	11
3.3. EM1 Current consumption vs supply voltage, all peripheral clocks disabled, HFRCO running at 28MHz .....	12
3.4. EM1 Current consumption vs temperature, all peripheral clocks disabled, HFRCO running at 28MHz .....	13
3.5. EM2 Current consumption vs supply voltage .....	14
3.6. EM2 Current consumption vs temperature .....	14
3.7. EM3 Current consumption vs supply voltage .....	15
3.8. EM3 Current consumption vs temperature .....	15
3.9. EM4 Current consumption vs supply voltage .....	16
3.10. EM4 Current consumption vs temperature .....	16
3.11. Integral Non-Linearity (INL) .....	24
3.12. Differential Non-Linearity (DNL) .....	24
4.1. QFN32 .....	31

## List of Tables

1.1. Ordering Information .....	2
2.1. Configuration Summary .....	6
3.1. Absolute Maximum Ratings .....	8
3.2. General Operating Conditions .....	8
3.3. Environmental .....	9
3.4. Current Consumption .....	9
3.5. Energy Modes Transitions .....	17
3.6. Power Management .....	17
3.7. Flash .....	18
3.8. GPIO .....	18
3.9. LFXO .....	19
3.10. HFXO .....	19
3.11. LFRCO .....	20
3.12. HFRCO .....	20
3.13. ADC .....	20
3.14. DAC .....	24
3.15. ACMP .....	26
3.16. VCMP .....	27
3.17. Digital Peripherals .....	27
4.1. Device Pinout .....	29
4.2. GPIO Pinout .....	30
4.3. QFN32 (Dimensions in mm) .....	31

## List of Equations

3.1. Total ACMP Active Current .....	26
3.2. VCMP Trigger Level as a Function of Level Setting .....	27

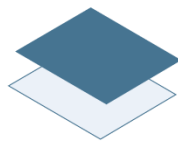

**ENERGY**<sup>®</sup>  
*micro*

*Energy Micro AS  
Sandakerveien 118  
P.O. Box 4633 Nydalen  
N-0405 Oslo  
Norway*

*[www.energymicro.com](http://www.energymicro.com)*