

# TrenchMV™ Power MOSFET

## IXTP60N10TM

$$V_{DSS} = 100V$$

$$I_{D25} = 33A$$

$$R_{DS(on)} \leq 19m\Omega$$

N-Channel Enhancement Mode  
Avalanche Rated

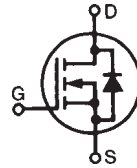

Symbol	Test Conditions	Maximum Ratings	
$V_{DSS}$	$T_J = 25^\circ C$ to $175^\circ C$	100	V
$V_{DGR}$	$T_J = 25^\circ C$ to $175^\circ C$ , $R_{GS} = 1M\Omega$	100	V
$V_{GSM}$	Transient	$\pm 30$	V
$I_{D25}$	$T_C = 25^\circ C$	33	A
$I_{DM}$	$T_C = 25^\circ C$ , pulse width limited by $T_{JM}$	180	A
$I_A$	$T_C = 25^\circ C$	10	A
$E_{AS}$	$T_C = 25^\circ C$	500	mJ
$P_D$	$T_C = 25^\circ C$	60	W
$T_J$		-55 ... +175	$^\circ C$
$T_{JM}$		175	$^\circ C$
$T_{stg}$		-55 ... +175	$^\circ C$
$T_L$	1.6mm (0.062in.) from case for 10s	300	$^\circ C$
$T_{SOLD}$	Plastic body for 10 seconds	260	$^\circ C$
$M_d$	Mounting torque	1.13/10	Nm/lb.in
<b>Weight</b>		2.5	g

OVERMOLDED TO-220 W/ FORMED  
LEAD (IXTP...M)

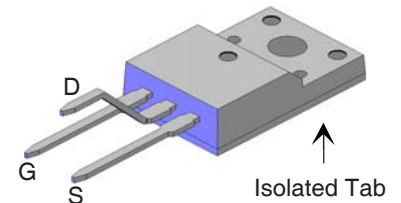

G = Gate      D = Drain  
S = Source

### Features

- Plastic overmolded tab for electrical isolation
- Low  $R_{DS(ON)}$ 
  - for minimum on-state conduction losses
- Fast switching

### Advantages

- Easy to mount
- Space savings
- High power density

### Applications

- DC-DC converters
- Battery chargers
- Switched-mode and resonant-mode power supplies
- DC choppers
- AC motor drives
- Uninterruptible power supplies
- High speed power switching applications

Symbol	Test Conditions ( $T_J = 25^\circ C$ unless otherwise specified)	Characteristic Values		
		Min.	Typ.	Max.
$BV_{DSS}$	$V_{GS} = 0V$ , $I_D = 250\mu A$	100		V
$V_{GS(th)}$	$V_{DS} = V_{GS}$ , $I_D = 50\mu A$	2.5		4.5 V
$I_{GSS}$	$V_{GS} = \pm 20V$ , $V_{DS} = 0V$			$\pm 100$ nA
$I_{DSS}$	$V_{DS} = V_{DSS}$ $V_{GS} = 0V$ $T_J = 150^\circ C$			1 $\mu A$ 100 $\mu A$
$R_{DS(on)}$	$V_{GS} = 10V$ , $I_D = 25A$ , Notes 1, 2			19 m $\Omega$

Symbol	Test Conditions	Characteristic Values		
		Min.	Typ.	Max.
$(T_J = 25^\circ\text{C unless otherwise specified})$				
$g_{fs}$	$V_{DS} = 10\text{V}, I_D = 0.5 \cdot I_{D25}, \text{ Note 1}$	25	42	S
$C_{iss}$	$V_{GS} = 0\text{V}, V_{DS} = 25\text{V}, f = 1\text{MHz}$		2650	pF
$C_{oss}$			335	pF
$C_{rss}$			60	pF
$t_{d(on)}$	<b>Resistive Switching Times</b> $V_{GS} = 10\text{V}, V_{DS} = 0.5 \cdot V_{DSS}, I_D = 10\text{A}$ $R_G = 15\Omega \text{ (External)}$		27	ns
$t_r$			40	ns
$t_{d(off)}$			43	ns
$t_f$			37	ns
$Q_{g(on)}$	$V_{GS} = 10\text{V}, V_{DS} = 0.5 \cdot V_{DSS}, I_D = 10\text{A}$		49	nC
$Q_{gs}$			15	nC
$Q_{gd}$			11	nC
$R_{thJC}$				2.5 °C/W

### Source-Drain Diode

Symbol	Test Conditions	Characteristic Values		
		Min.	Typ.	Max.
$T_J = 25^\circ\text{C unless otherwise specified}$				
$I_S$	$V_{GS} = 0\text{V}$			60 A
$I_{SM}$	Repetitive, pulse width limited by $T_{JM}$			240 A
$V_{SD}$	$I_F = 25\text{A}, V_{GS} = 0\text{V}, \text{ Note 1}$			1.2 V
$t_{rr}$	$I_F = 30\text{A}, V_{GS} = 0\text{V}$ $-di/dt = 100\text{A}/\mu\text{s}$ $V_R = 50\text{V}$		59	ns
$I_{RM}$			3.8	A
$Q_{RM}$			112	nC

- Notes
1. Pulse test,  $t \leq 300 \mu\text{s}$ ; duty cycle,  $d \leq 2\%$ .
  2. On through-hole packages,  $R_{DS(on)}$  Kelvin test contact location must be 5mm or less from the package body.

### OVERMOLDED TO-220 W/ FORMED LEAD (IOTP...M)

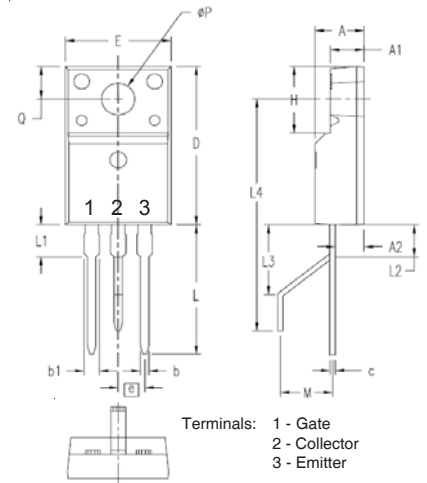

SYM	INCHES		MILLIMETERS	
	MIN	MAX	MIN	MAX
A	.177	.193	4.50	4.90
A1	.092	.108	2.34	2.74
A2	.101	.117	2.56	2.96
b	.028	.035	0.70	0.90
b1	.050	.058	1.27	1.47
c	.016	.024	0.40	0.60
D	.617	.633	15.67	16.07
E	.392	.408	9.96	10.36
e	.100 BSC		2.54 BSC	
H	.255	.271	6.48	6.88
L	.500	.523	12.70	13.30
L1	.119	.135	3.03	3.43
L2	.098	.138	2.50	3.50
L3	.256	.295	6.50	7.50
L4	.906	.945	23.00	24.00
M	.177	.216	4.50	5.50
ØP	.121	.129	3.08	3.28
Q	.126	.134	3.20	3.40

### PRELIMINARY TECHNICAL INFORMATION

The product presented herein is under development. The Technical Specifications offered are derived from data gathered during objective characterizations of preliminary engineering lots; but also may yet contain some information supplied during a pre-production design evaluation. IXYS reserves the right to change limits, test conditions, and dimensions without notice.

IXYS reserves the right to change limits, test conditions, and dimensions.

IXYS MOSFETs and IGBTs are covered by one or more of the following U.S. patents:

4,835,592	4,931,844	5,049,961	5,237,481	6,162,665	6,404,065 B1	6,683,344	6,727,585	7,005,734 B2	7,157,338B2
4,850,072	5,017,508	5,063,307	5,381,025	6,259,123 B1	6,534,343	6,710,405 B2	6,759,692	7,063,975 B2	
4,881,106	5,034,796	5,187,117	5,486,715	6,306,728 B1	6,583,505	6,710,463	6,771,478 B2	7,071,537	

**Fig. 1. Output Characteristics @ 25°C**

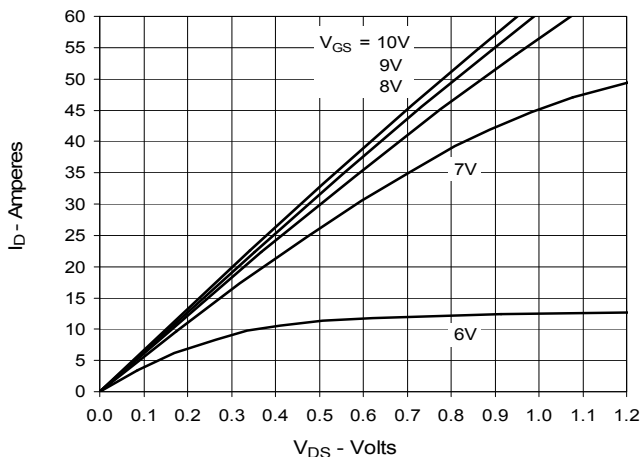

**Fig. 2. Extended Output Characteristics @ 25°C**

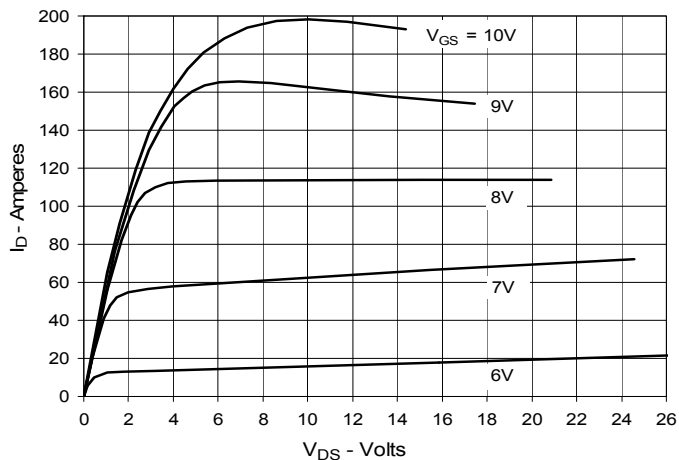

**Fig. 3. Output Characteristics @ 150°C**

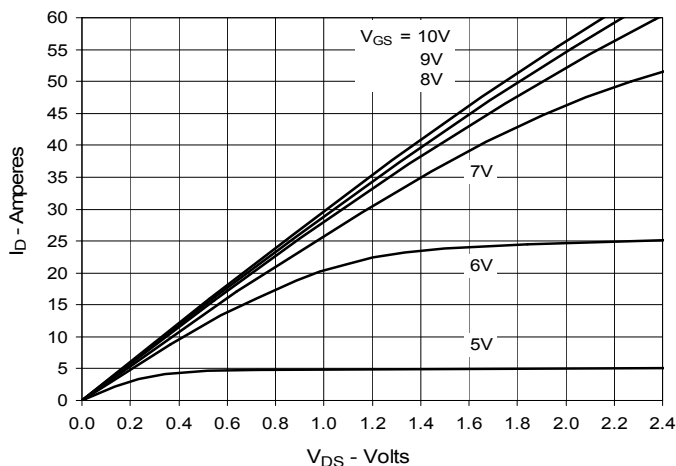

**Fig. 4.  $R_{DS(on)}$  Normalized to  $I_D = 30A$  Value vs. Junction Temperature**

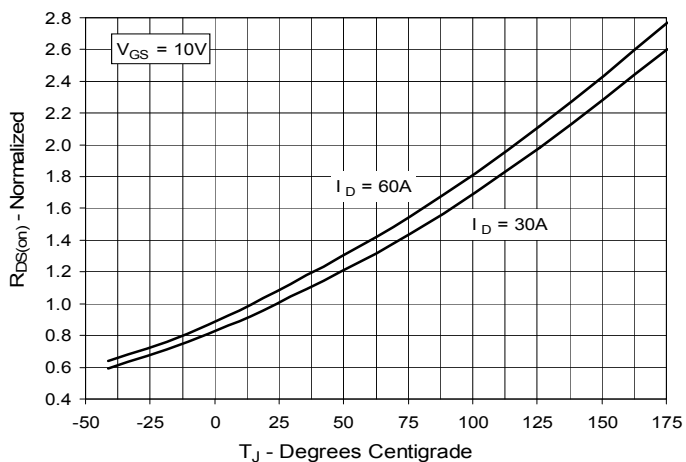

**Fig. 5.  $R_{DS(on)}$  Normalized to  $I_D = 30A$  Value vs. Drain Current**

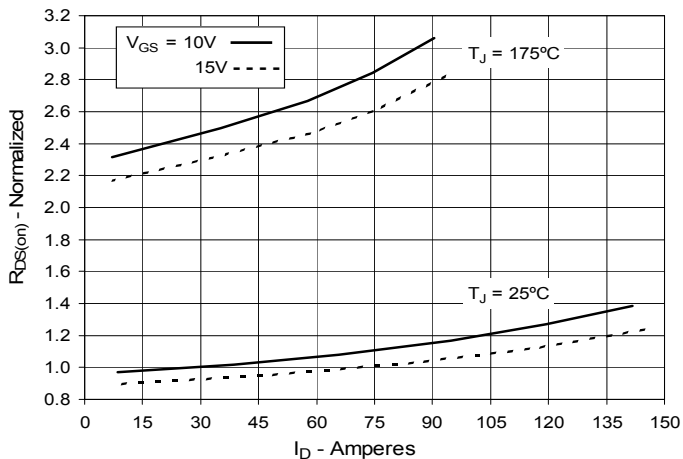

**Fig. 6. Drain Current vs. Case Temperature**

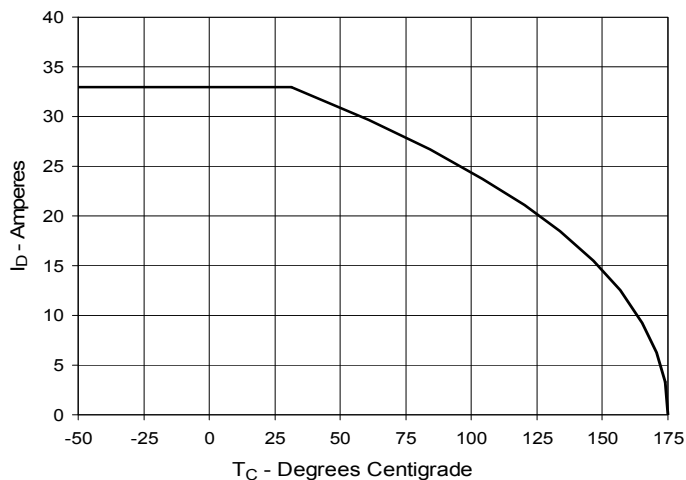

**Fig. 7. Input Admittance**

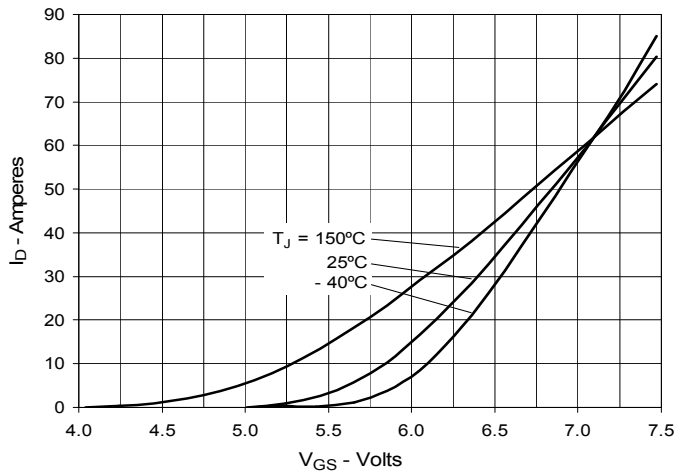

**Fig. 8. Transconductance**

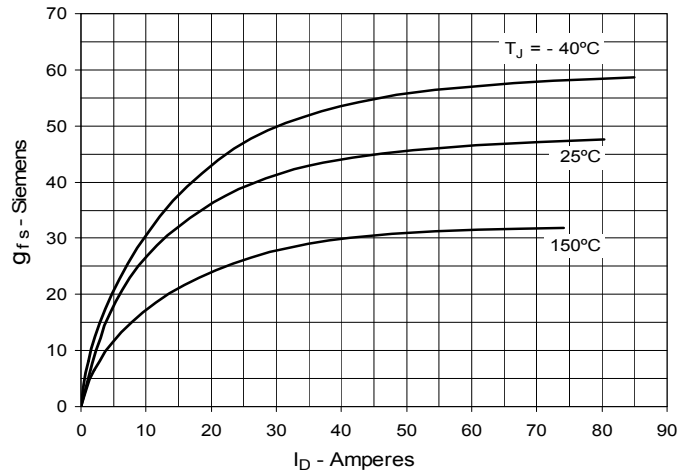

**Fig. 9. Forward Voltage Drop of Intrinsic Diode**

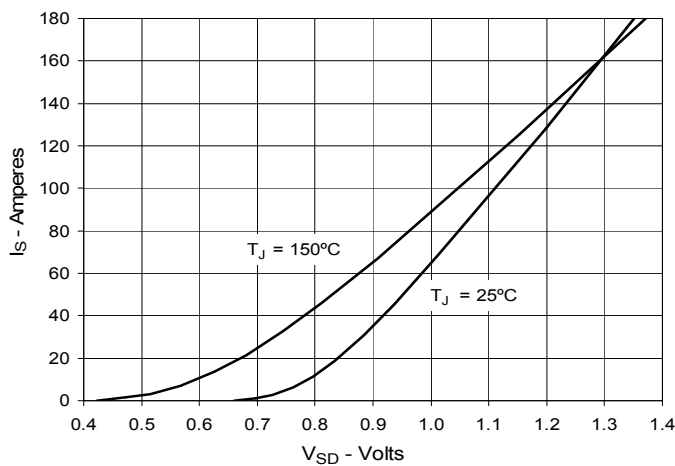

**Fig. 10. Gate Charge**

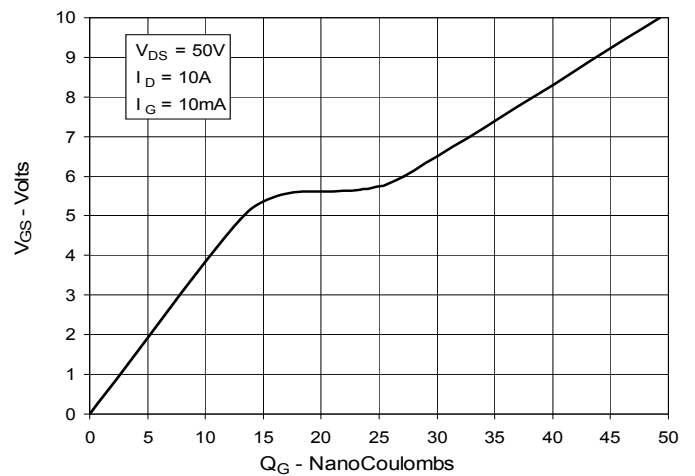

**Fig. 11. Capacitance**

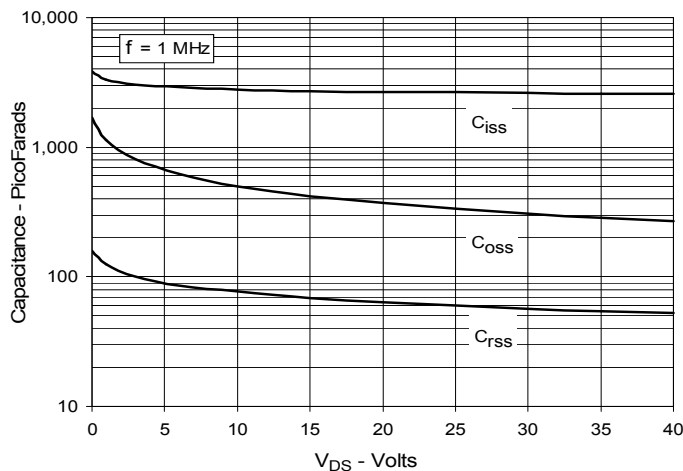

**Fig. 12. Maximum Transient Thermal Impedance**

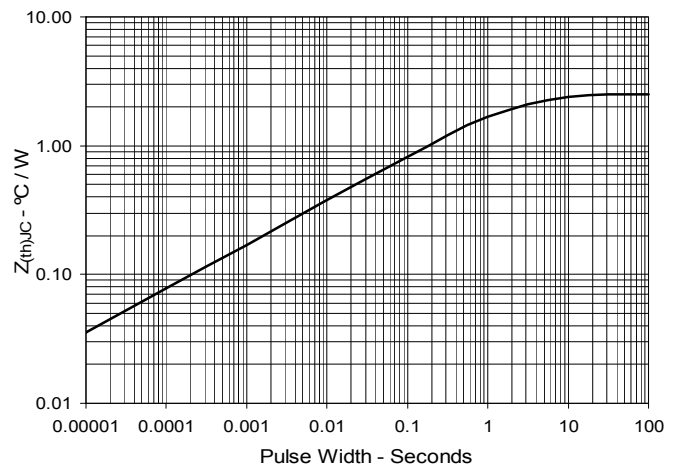

IXYS reserves the right to change limits, test conditions, and dimensions.

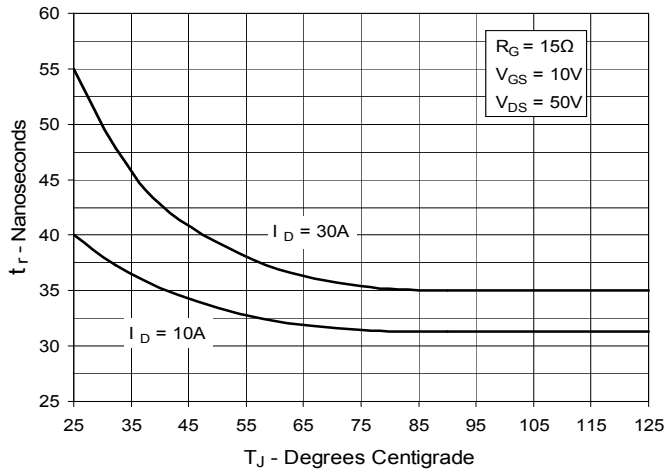
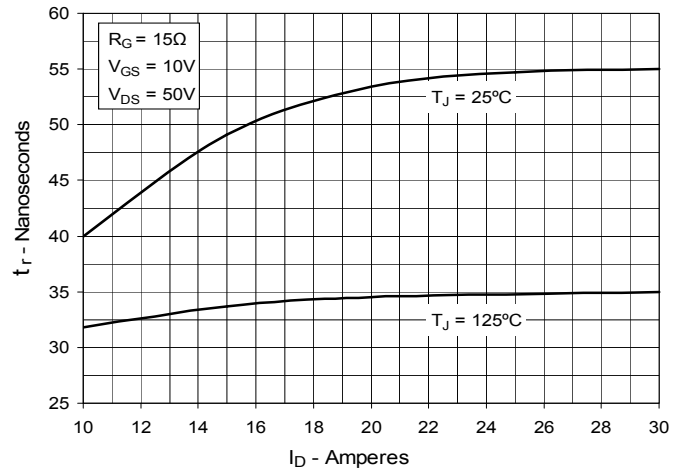
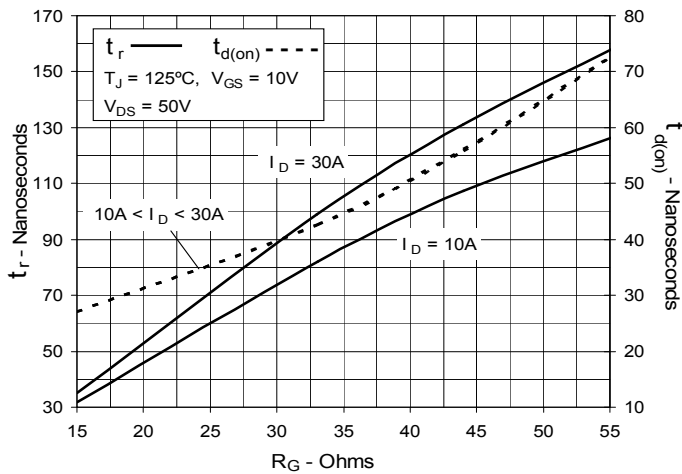
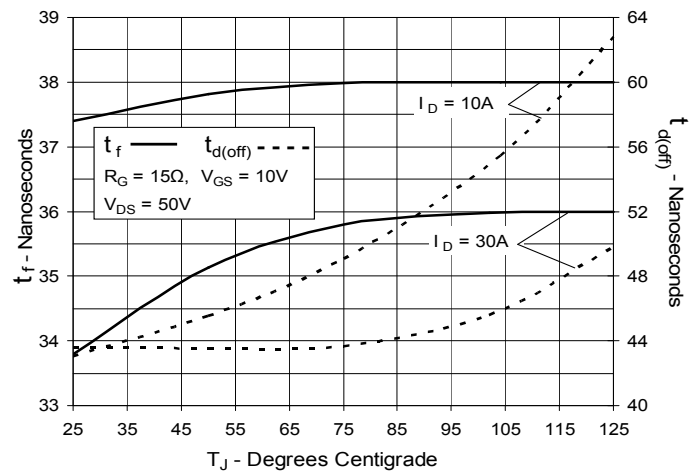
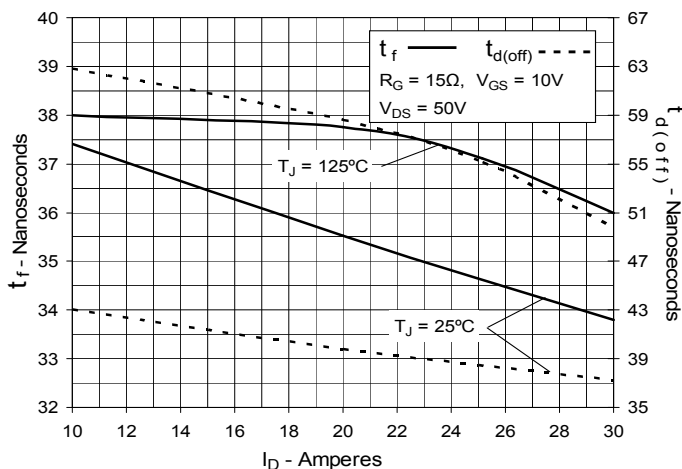
**Fig. 13. Resistive Turn-on Rise Time vs. Junction Temperature**

**Fig. 14. Resistive Turn-on Rise Time vs. Drain Current**

**Fig. 15. Resistive Turn-on Switching Times vs. Gate Resistance**

**Fig. 16. Resistive Turn-off Switching Times vs. Junction Temperature**

**Fig. 17. Resistive Turn-off Switching Times vs. Drain Current**

**Fig. 18. Resistive Turn-off Switching Times vs. Gate Resistance**
