

PRELIMINARY SPEC

Part Number : KA-1010QB9ZC

Blue



ATTENTION
OBSERVE PRECAUTIONS
FOR HANDLING
ELECTROSTATIC
DISCHARGE
SENSITIVE
DEVICES

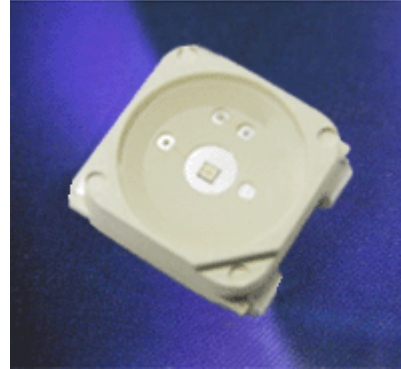

Features

- PLCC-4 PACKAGE.
- SINGLE COLOR.
- HIGH LUMINANCE.
- HIGH POWER, OPERATING CURRENT @350mA.
- SUITABLE FOR ALL SMT ASSEMBLY METHODS.
- PACKAGE : 500PCS / REEL.
- MOISTURE SENSITIVITY LEVEL : LEVEL 4.
- PATENT PENDING.
- RoHS COMPLIANT.

Description

The LED is encapsulated with a soft silicone material.

Package Dimensions

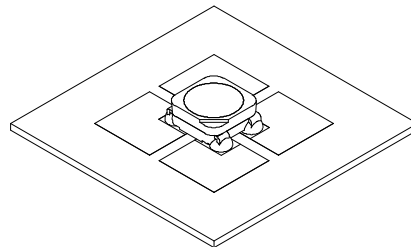
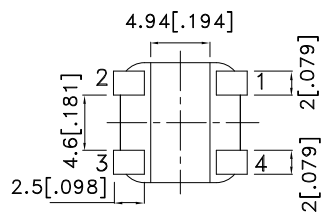
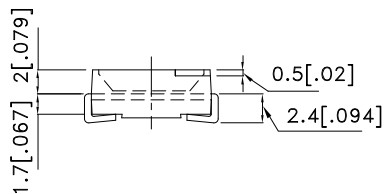
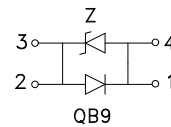
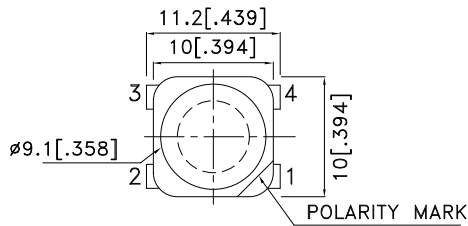

Notes:

1. All dimensions are in millimeters (inches).
2. Tolerance is $\pm 0.25(0.01)$ unless otherwise noted.
3. Specifications are subject to change without notice.
4. The device has a single mounting surface. The device must be mounted according to the specifications.



Applications

- traffic signaling.
- backlighting (illuminated advertising , general lighting).
- interior and exterior automotive lighting.
- substitution of micro incandescent lamps.
- portable light source (e.g. bicycle flashlight).
- signal and symbol luminaire for orientation.
- marker lights (e.g. steps, exit ways, etc).
- decorative and entertainment lighting.
- indoor and outdoor commercial and residential architectural lighting.

Application Notes

- Pressure or stress can damage the encapsulating material and affect the reliability of the LED.
Precaution should be taken to avoid pressure on the LED encapsulating surface.
- Static electricity and surge damage the LEDs.
It is recommended to use a wrist band or anti-electrostatic glove when handling the LEDs.
All devices, equipment and machinery must be electrically grounded.
- Handling Indications
Use proper handling techniques to prevent damage to the LED surface. Minimize mechanical stress on the LED surface during processing and handling. Do not touch the emitting surface with sharp objects to avoid scratching or damaging the LED.



Figure 1

In general, LEDs should be handled by the sides of the package. Handling instruments should not touch the emitting surface of the LED package.



Figure 2

For automated pick-and-place machines, the pickup nozzle should be larger than the size of the LED reflector area to avoid placing excess pressure on the LED surface.

Selection Guide

Part No.	Dice	Lens Type	luminous Intensity [2] Iv(cd)@ 350 mA		Φv (lm) [2] @ 350 mA		Viewing Angle [1]
			Min.	Typ.	Min.	Typ.	2θ1/2
KA-1010QB9ZC	BLUE (AlInGaN)	WATER CLEAR	0.9	1.4	2.9	4.5	120°

Notes:

- 1.θ1/2 is the angle from optical centerline where the luminous intensity is 1/2 the optical centerline value.
2. Luminous intensity/ luminous Flux: +/-15%.

Absolute Maximum Ratings at TA=25°C

Parameter	Symbol	Value	Unit
Power dissipation	Pt	1.22	W
Junction temperature	TJ	110	°C
Operating Temperature	Top	-40 To +85	°C
Storage Temperature	Tstg	-40 To +85	°C
DC Forward Current [1]	IF	350	mA
Peak Forward Current [2]	IFM	500	mA
Thermal resistance [1]	Rth	55	°C/W

Notes:

- 1.Results from mounting on PC board FR4(pad size≥100mm² per pad), mounted on pc board-metal core PCB is recommend for lowest thermal Resistance.
- 2.1/10 Duty Cycle, 0.1ms Pulse Width.

Electrical / Optical Characteristics at TA=25°C

Parameter	Symbol	Value	Unit
Wavelength at peak emission IF=350mA [Typ.]	λpeak	464	nm
Dominant Wavelength IF=350mA [Typ.]	λDom [1]	466	nm
Spectral bandwidth at 50%ΦREL MAX IF=350mA [Typ.]	Δλ	30	nm
Forward Voltage IF=350mA [Min.]	VF [2]	2.7	V
Forward Voltage IF=350mA [Typ.]		3.5	
Forward Voltage IF=350mA [Max.]		3.8	
Temperature coefficient of λpeak IF=350mA, -10°C≤T≤100°C [Typ.]	TCλpeak	0.15	nm/°C
Temperature coefficient of λdom IF=350mA, -10°C≤T≤100°C [Typ.]	TCλdom	0.13	nm/°C
Temperature coefficient of VF IF=350mA, -10°C≤T≤100°C [Typ.]	TCv	-2.0	mV/°C

Notes:

- 1.Wavelength: +/-1nm.
2. Forward Voltage: +/-0.1V.

KA-1010QB9ZC

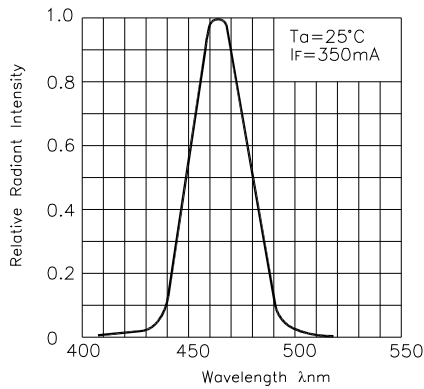

RELATIVE INTENSITY VS. WAVELENGTH

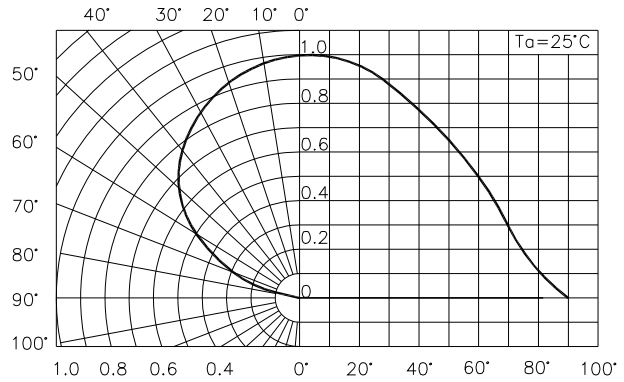

SPATIAL DISTRIBUTION

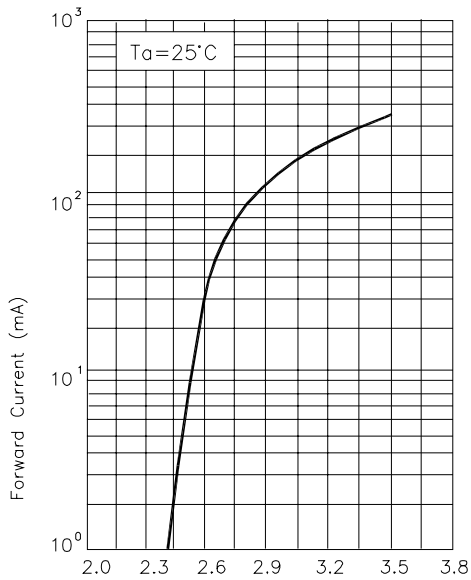

FORWARD CURRENT VS. FORWARD VOLTAGE

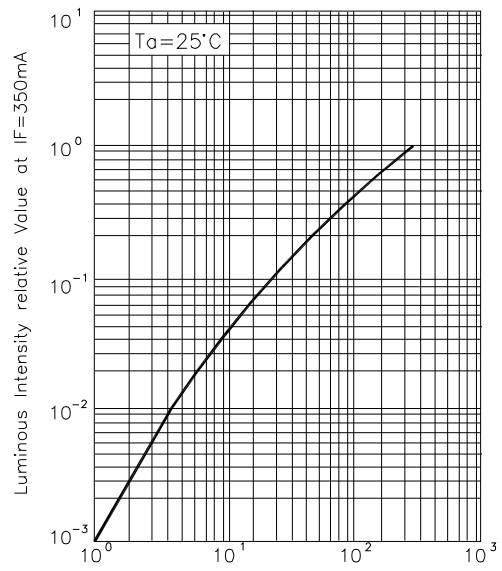

LUMINOUS INTENSITY VS. FORWARD CURRENT

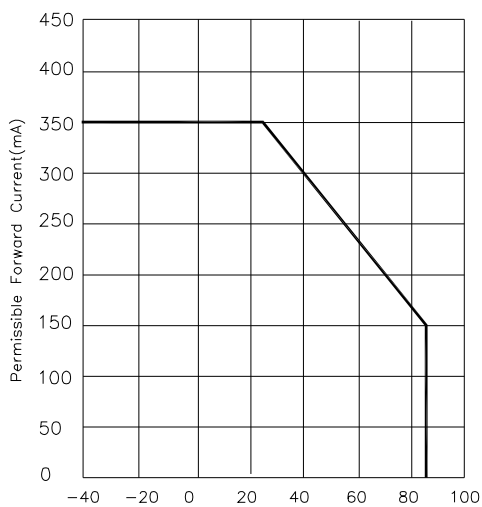

DERATING CURVE

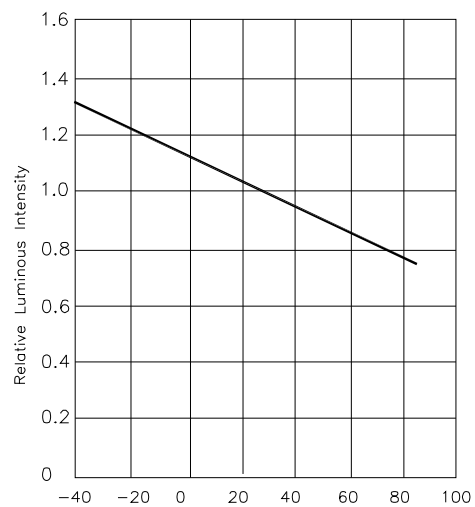

LUMINOUS INTENSITY VS. AMBIENT TEMPERATURE

PACKING & LABEL SPECIFICATIONS

KA-1010QB9ZC

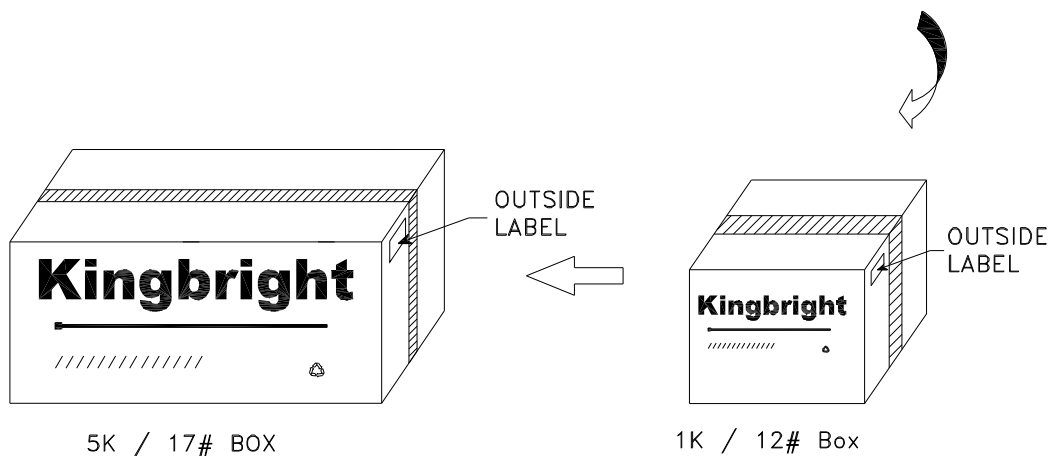
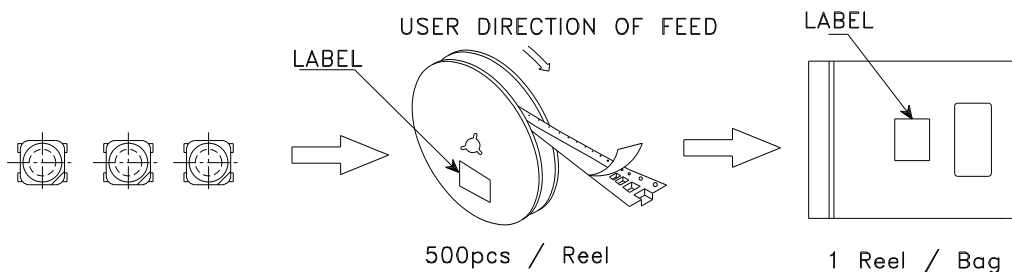

<h1>Kingbright</h1>	
P/NO: KA-1010XXX	
QTY: 500 pcs	Q.C. Q C XX XX XXXX PASSED
S/N: XXXX	
CODE: XXX	
LOT NO:	
 xxxxxxxxxxxxxxxxxxxxxxxxxxxx	
RoHS Compliant	