

PRELIMINARY SPEC

Part Number: KA-3528APBS-Z

Blue



**ATTENTION**  
OBSERVE PRECAUTIONS  
FOR HANDLING  
ELECTROSTATIC  
DISCHARGE  
SENSITIVE  
DEVICES

**Features**

- SINGLE COLOR.
- SUITABLE FOR ALL SMT ASSEMBLY AND SOLDER PROCESS.
- AVAILABLE ON TAPE AND REEL.
- IDEAL FOR BACKLIGHTING.
- PACKAGE : 1500PCS / REEL.
- MOISTURE SENSITIVITY LEVEL : LEVEL 5.
- RoHS COMPLIANT.

**Description**

The Blue source color devices are made with InGaN Light Emitting Diode.  
Static electricity and surge damage the LEDs.  
It is recommended to use a wrist band or anti-electrostatic glove when handling the LEDs.  
All devices, equipment and machinery must be electrically grounded.

**Package Dimensions**

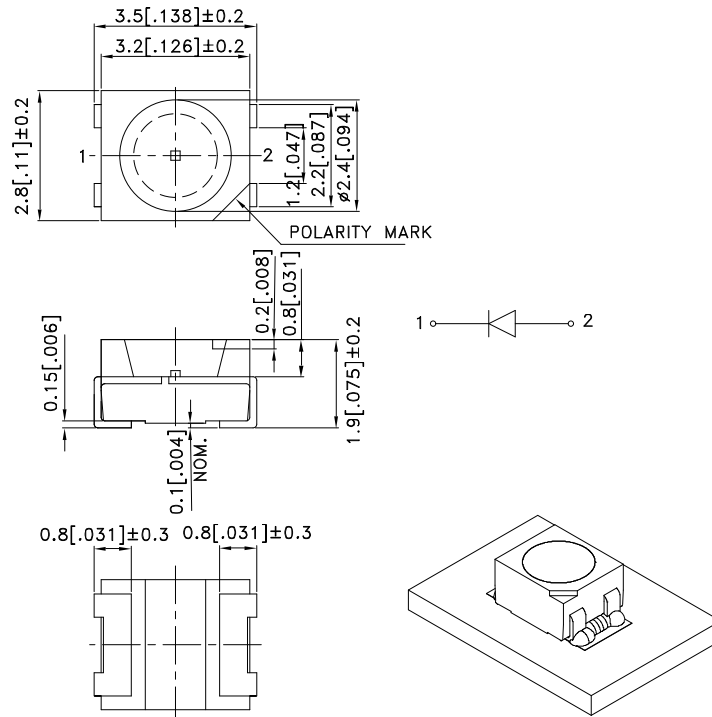

Notes:

1. All dimensions are in millimeters (inches).
2. Tolerance is ±0.25(0.01") unless otherwise noted.
3. Specifications are subject to change without notice.
4. The device has a single mounting surface. The device must be mounted according to the specifications.



## Handling Precautions

Compare to epoxy encapsulant that is hard and brittle, silicone is softer and flexible. Although its characteristic significantly reduces thermal stress, it is more susceptible to damage by external mechanical force.

As a result, special handling precautions need to be observed during assembly using silicone encapsulated LED products. Failure to comply might leads to damage and premature failure of the LED.

1. Handle the component along the side surfaces by using forceps or appropriate tools.

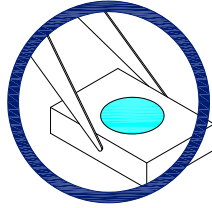

2. Do not directly touch or handle the silicone lens surface. It may damage the internal circuitry.

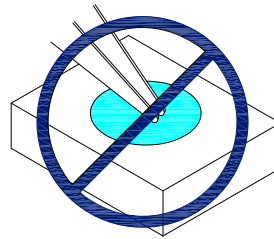
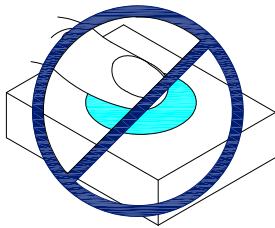

3. Do not stack together assembled PCBs containing exposed LEDs. Outside impact may scratch the silicone lens or damage the internal circuitry.

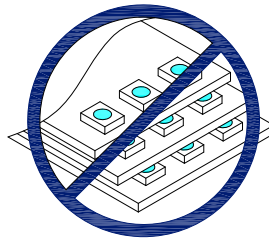

4. During surface-mounting, the pickup capillary diameter should be larger than the silicone lens to insure the capillary does not scratch or damage the lens.

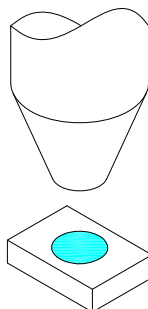

## Selection Guide

Part No.	Dice	Lens Type	Iv (mcd) [2] @ 20mA		Viewing Angle [1]
			Min.	Typ.	2θ1/2
KA-3528APBS-Z	Blue (InGaN)	WATER CLEAR	180	350	120°

Notes:

1. θ1/2 is the angle from optical centerline where the luminous intensity is 1/2 the optical centerline value.
2. Luminous intensity/ luminous Flux: +/-15%.

## Electrical / Optical Characteristics at TA=25°C

Symbol	Parameter	Device	Typ.	Max.	Units	Test Conditions
$\lambda_{peak}$	Peak Wavelength	Blue	458		nm	I <sub>F</sub> =20mA
$\lambda_D$ [1]	Dominant Wavelength	Blue	465		nm	I <sub>F</sub> =20mA
$\Delta\lambda_{1/2}$	Spectral Line Half-width	Blue	22		nm	I <sub>F</sub> =20mA
C	Capacitance	Blue	110		pF	V <sub>F</sub> =0V;f=1MHz
V <sub>F</sub> [2]	Forward Voltage	Blue	3.2	3.7	V	I <sub>F</sub> =20mA
I <sub>R</sub>	Reverse Current	Blue		10	uA	V <sub>R</sub> =5V

Notes:

1. Wavelength: +/-1nm.
2. Forward Voltage: +/-0.1V.

## Absolute Maximum Ratings at TA=25°C

Parameter	Blue	Units
Power dissipation	111	mW
DC Forward Current	30	mA
Peak Forward Current [1]	100	mA
Reverse Voltage	5	V
Operating Temperature	-40°C To +85°C	
Storage Temperature	-40°C To +85°C	

Note:

1. 1/10 Duty Cycle, 0.1ms Pulse Width.

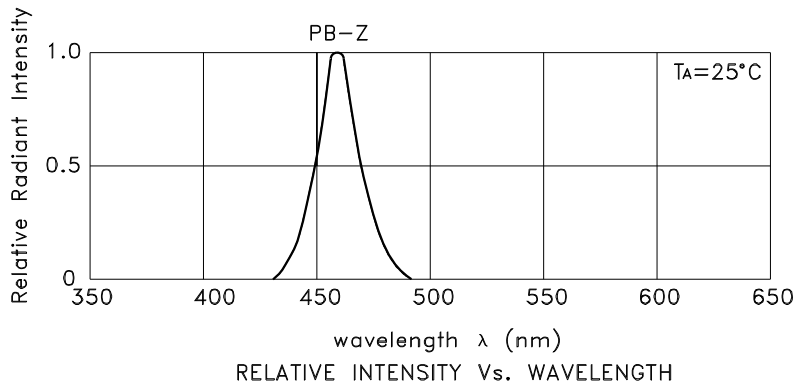

## Blue

### KA-3528APBS-Z

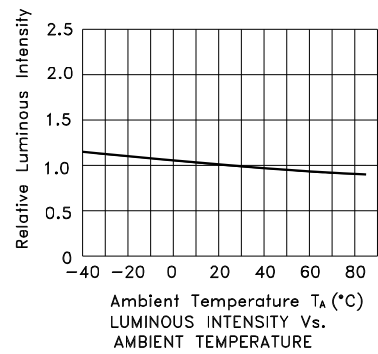
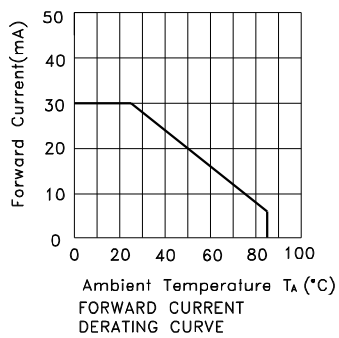
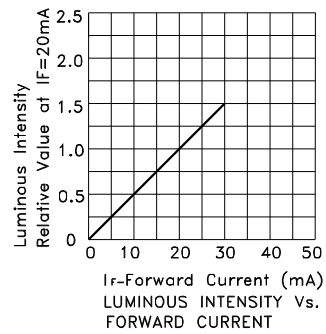
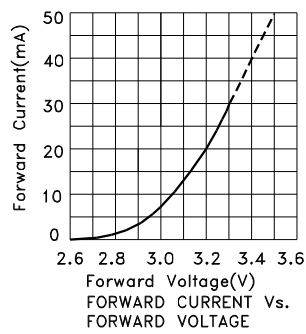

## KA-3528APBS-Z

Reflow Soldering Profile For Lead-free SMT Process.

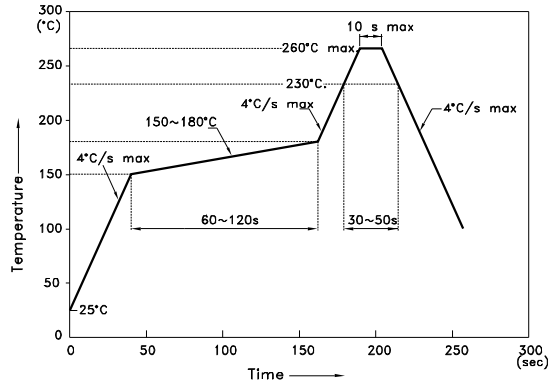

NOTES:

1. We recommend the reflow temperature 245°C(+/-5°C). The maximum soldering temperature should be limited to 260°C.
2. Don't cause stress to the epoxy resin while it is exposed to high temperature.
3. Number of reflow process shall be 2 times or less.

### Recommended Soldering Pattern (Units : mm; Tolerance: ± 0.1)

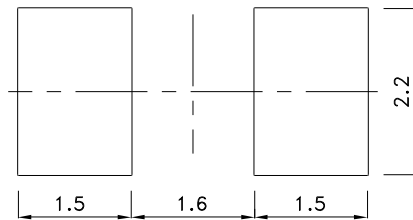

### Tape Specifications (Units : mm)

