

PRELIMINARY SPEC

P/N: KCSA56-105

HYPER RED

### Features

- 0.56 INCH DIGIT HEIGHT.
- LOW CURRENT OPERATION.
- EXCELLENT CHARACTER APPEARANCE.
- I.C. COMPATIBLE.
- MECHANICALLY RUGGED.
- GRAY FACE, WHITE SEGMENT.
- PACKAGE: 400 PCS/ REEL.
- MOISTURE SENSITIVITY LEVEL : LEVEL 4.
- RoHS COMPLIANT.

### Description

The Hyper Red source color devices are made with DH InGaAlP on GaAs substrate Light Emitting Diode.

### Package Dimensions & Internal Circuit Diagram

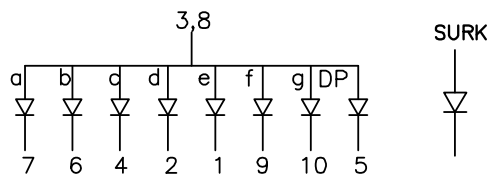
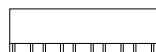
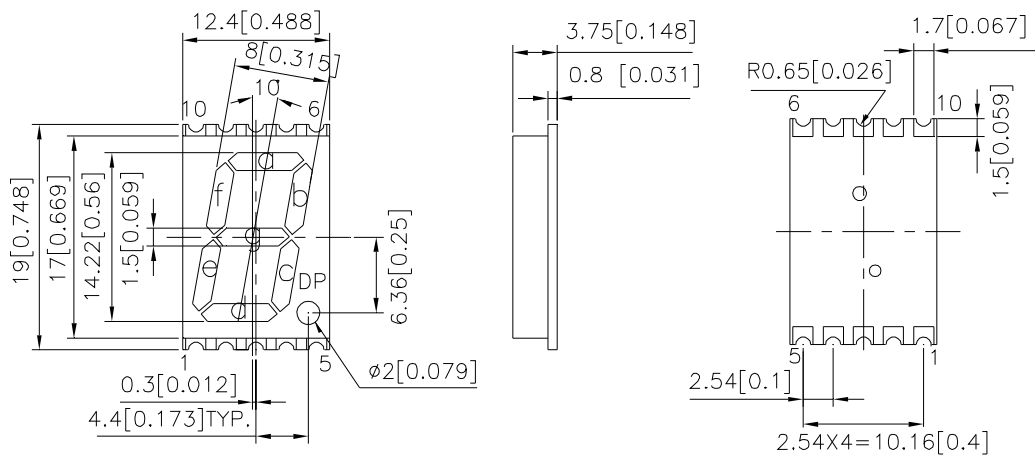

**Notes:**

1. All dimensions are in millimeters (inches), Tolerance is  $\pm 0.25(0.01)$  unless otherwise noted.
2. Specifications are subject to change without notice.
3. The gap between the reflector and PCB shall not exceed 0.25mm

## Selection Guide

Part No.	Dice	Lens Type	Iv (ucd) [1] @ 10mA		Description
			Min.	Typ.	
KCSA56-105	HYPER RED (InGaAlP)	WHITE DIFFUSED	4700	30000	Common Anode, Rt. Hand Decimal.

Note:

1. Luminous Intensity / Luminous Flux: +/-15%.

## Electrical / Optical Characteristics at T<sub>A</sub>=25°C

Symbol	Parameter	Device	Typ.	Max.	Units	Test Conditions
$\lambda_{peak}$	Peak Wavelength	Hyper Red	650		nm	I <sub>F</sub> =20mA
$\lambda_D$ [1]	Dominant Wavelength	Hyper Red	635		nm	I <sub>F</sub> =20mA
$\Delta\lambda_{1/2}$	Spectral Line Half-width	Hyper Red	28		nm	I <sub>F</sub> =20mA
C	Capacitance	Hyper Red	35		pF	V <sub>F</sub> =0V; f=1MHz
V <sub>F</sub> [2]	Forward Voltage	Hyper Red	1.95	2.5	V	I <sub>F</sub> =20mA
I <sub>R</sub>	Reverse Current	Hyper Red		10	uA	V <sub>R</sub> = 5V

Notes:

1. Wavelength: +/-1nm.

2. Forward Voltage: +/-0.1V.

## Absolute Maximum Ratings at T<sub>A</sub>=25°C

Parameter	Hyper Red	Units
Power dissipation	75	mW
DC Forward Current	30	mA
Peak Forward Current [1]	185	mA
Reverse Voltage	5	V
Operating / Storage Temperature	-40°C To +85°C	

Note:

1. 1/10 Duty Cycle, 0.1ms Pulse Width.

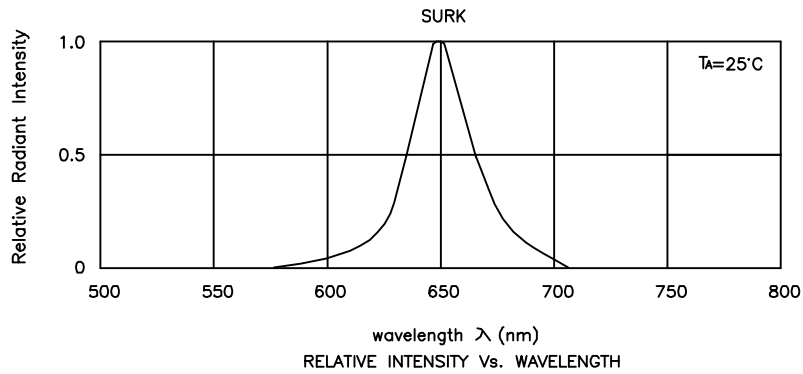

## Hyper Red

### KCSA56-105

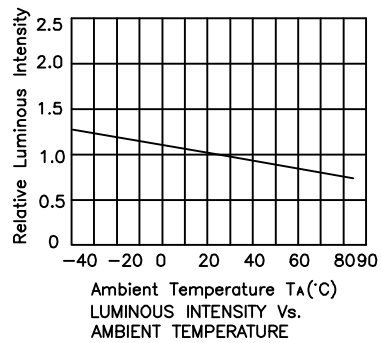
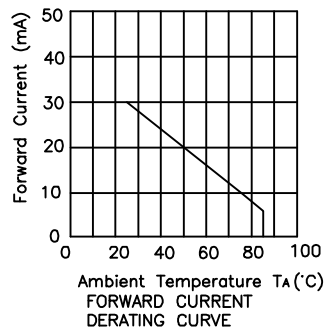
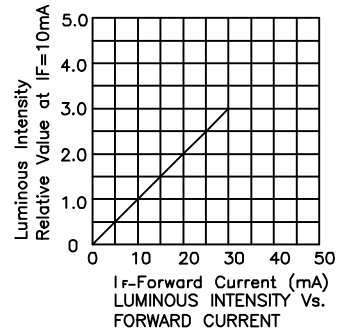
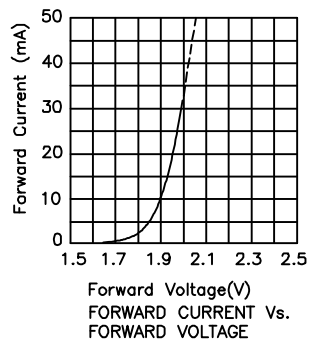

## KCSA56-105

Reflow Soldering Profile For Lead-free SMT Process.

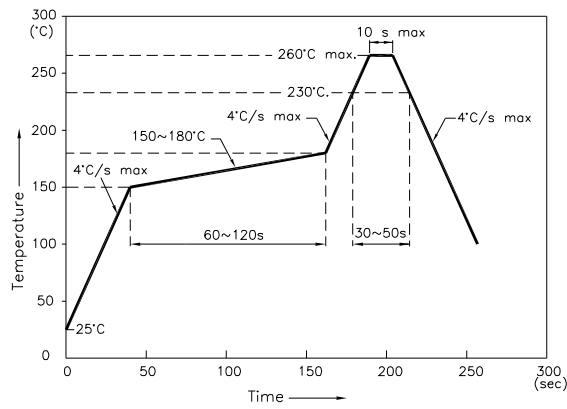

NOTES:

1. We recommend the reflow temperature 245°C(+/-5°C). The maximum soldering temperature should be limited to 260°C.
2. Don't cause stress to the epoxy resin while it is exposed to high temperature.
3. Number of reflow process shall be 2 times or less.

### Recommended Soldering Pattern (Units : mm)

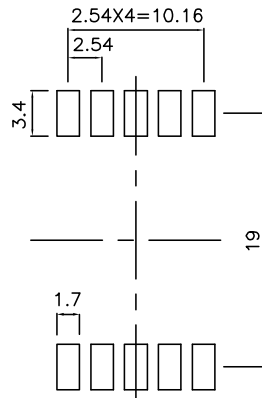

### Tape Specifications (Units : mm)

