

Part Number: TBC24-11EGWA

High Efficiency Red
Green

Features

- 2.4 INCH MATRIX HEIGHT.
- DOT SIZE 5mm.
- LOW CURRENT OPERATION.
- HIGH CONTRAST AND LIGHT OUTPUT.
- COMPATIBLE WITH ASCII AND EBCDIC CODES.
- STACKABLE HORIZONTALLY.
- EASY MOUNTING ON P.C. BOARDS OR SOCKETS.
- MULTICOLOR AVAILABLE.
- MECHANICALLY RUGGED.
- STANDARD : GRAY FACE, WHITE DOT.
- RoHS COMPLIANT

Description

The High Efficiency Red source color devices are made with Gallium Arsenide Phosphide on Gallium Phosphide Orange Light Emitting Diode.

The Green source color devices are made with Gallium Phosphide Green Light Emitting Diode.

Package Dimensions & Internal Circuit Diagram

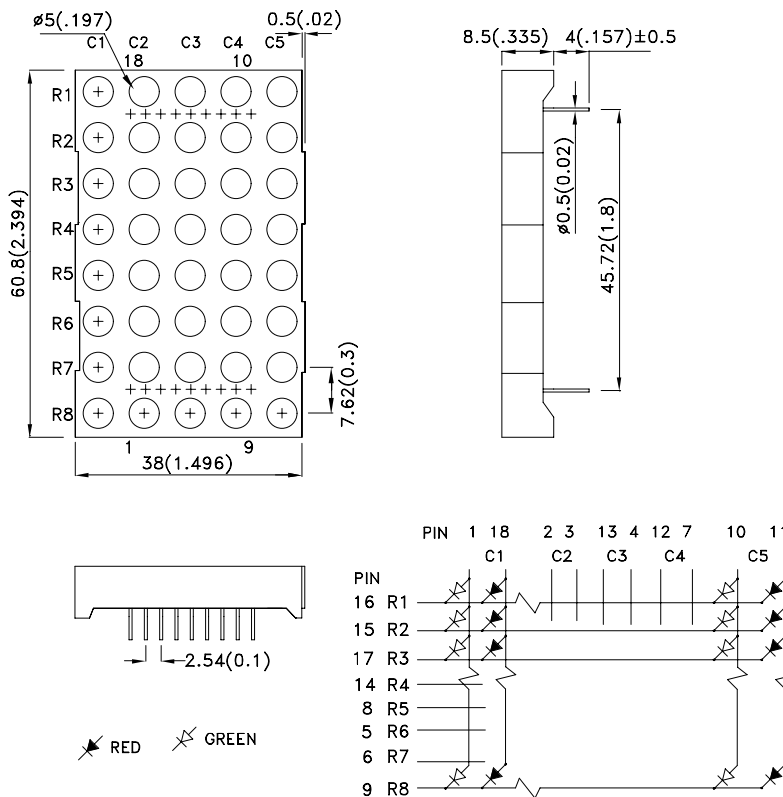

Notes:

1. All dimensions are in millimeters (inches), Tolerance is $\pm 0.25(0.01)$ unless otherwise noted.
2. Specifications are subject to change without notice.



Selection Guide

Part No.	Dice	Lens Type	Iv (ucd) [1] @ 10mA		Description
			Min.	Typ.	
TBC24-11EGWA	High Efficiency Red (GaAsP/GaP)	WHITE DIFFUSED	3000	13500	Column Cathode
	Green (GaP)		4700	20000	

Note:

1. Luminous intensity/ luminous Flux: +/-15%.

Electrical / Optical Characteristics at TA=25°C

Symbol	Parameter	Device	Typ.	Max.	Units	Test Conditions
λ_{peak}	Peak Wavelength	High Efficiency Red Green	627 565		nm	I _F =20mA
λ_D [1]	Dominant Wavelength	High Efficiency Red Green	625 568		nm	I _F =20mA
$\Delta\lambda_{1/2}$	Spectral Line Half-width	High Efficiency Red Green	45 30		nm	I _F =20mA
C	Capacitance	High Efficiency Red Green	15 15		pF	V _F =0V;f=1MHz
V _F [2]	Forward Voltage	High Efficiency Red Green	2.0 2.2	2.5 2.5	V	I _F =20mA
I _R	Reverse Current	High Efficiency Red Green		10	uA	V _R =5V

Notes:

1. Wavelength: +/-1nm.
2. Forward Voltage: +/-0.1V.

Absolute Maximum Ratings at TA=25°C

Parameter	High Efficiency Red	Green	Units
Power dissipation	75	62.5	mW
DC Forward Current	30	25	mA
Peak Forward Current [1]	160	140	mA
Reverse Voltage	5		V
Operating/Storage Temperature	-40°C To +85°C		
Lead Solder Temperature [2]	260°C For 3-5 Seconds		

Notes:

1. 1/10 Duty Cycle, 0.1ms Pulse Width.
2. 2mm below package base.

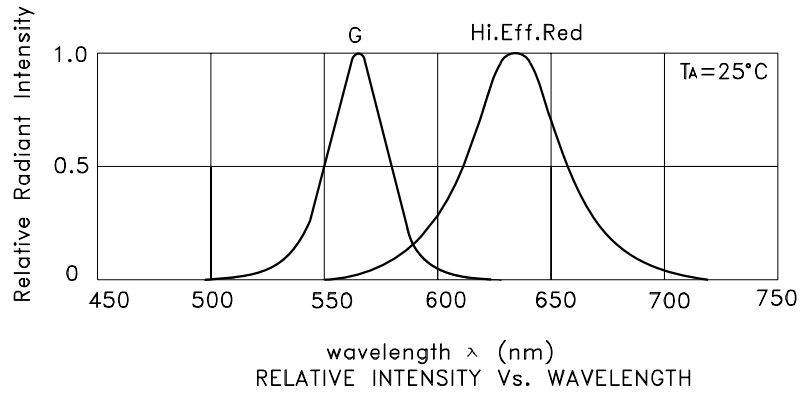

TBC24-11EGWA High Efficiency Red

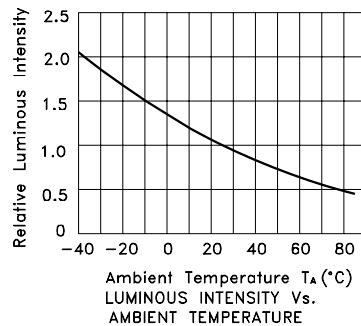
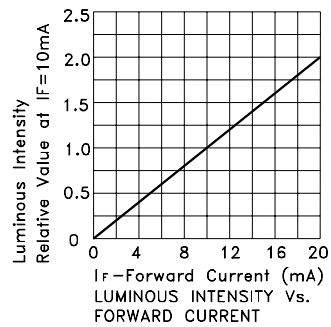

Green

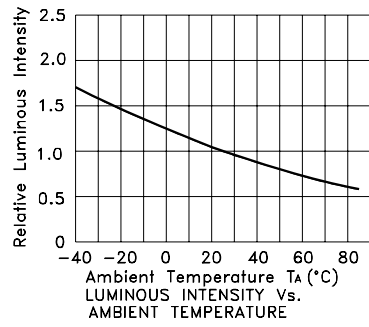
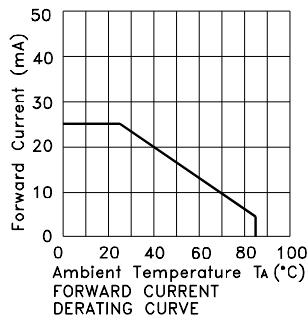
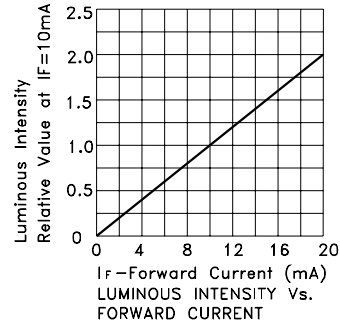
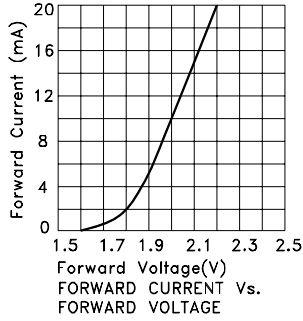

PACKING & LABEL SPECIFICATIONS

TBC24-11EGWA

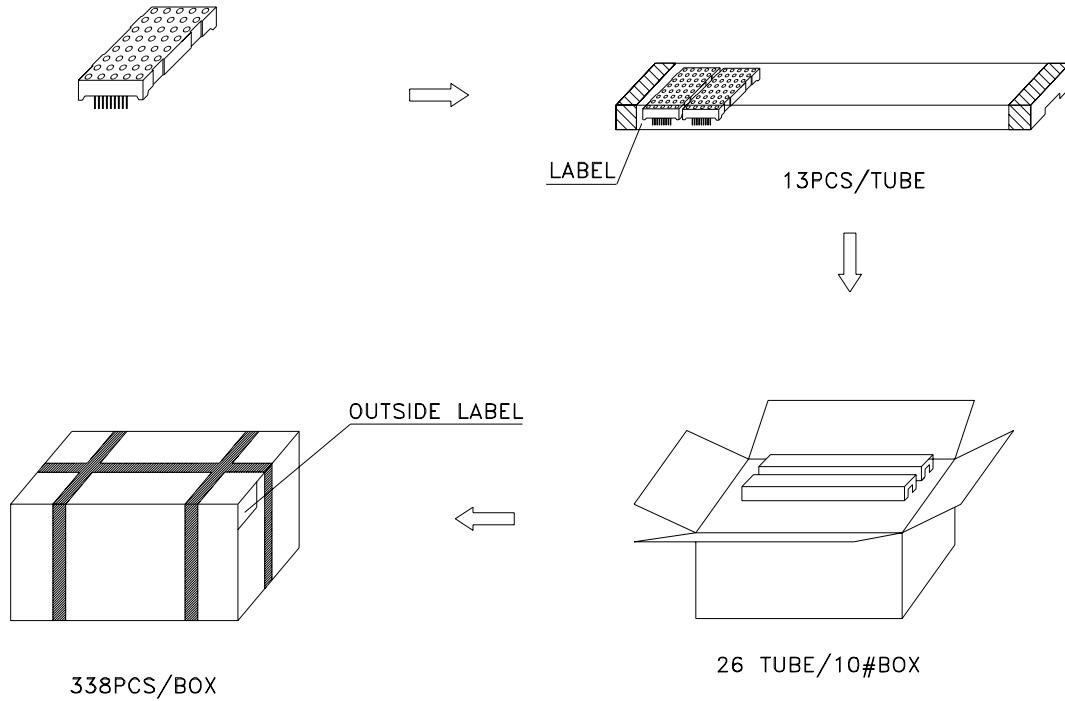

Inside LABEL Paste On The IC-tube

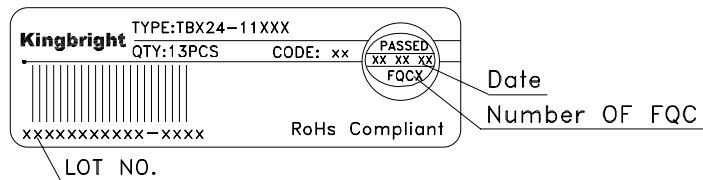

Outside LABEL Paste On The Box

