



Octal, 13-Bit Voltage-Output DAC with Parallel Interface

MX7839

General Description

The MX7839 contains eight 13-bit, voltage-output digital-to-analog converters (DACs). On-chip precision output amplifiers provide the voltage outputs. The device operates from $\pm 15V$ supplies. Its bipolar output voltage swing is $\pm 10V$ and is achieved with no external components. The MX7839 has three pairs of differential reference inputs; two of these pairs are connected to two DACs each, and a third pair is connected to four DACs. The references are independently controlled, providing different full-scale output voltages to the respective DACs.

The MX7839 features double-buffered interface logic with a 13-bit parallel data bus. Each DAC has an input latch and a DAC latch. Data in the DAC latch sets the output voltage. The eight input latches are addressed with three address lines. Data is loaded to the input latch with a single write instruction. An asynchronous load input (LDAC) transfers data from the input latch to the DAC latch. The LDAC input controls all DACs; therefore, all DACs can be updated simultaneously by asserting LDAC.

An asynchronous CLR input sets the output of all eight DACs to the respective DUTGND input of the op amp. Note that CLR is a CMOS input, which is powered by VDD. All other logic inputs are TTL/CMOS compatible.

The MX7839 is pin-for-pin compatible with AD7839.

Applications

- Automatic Test Equipment (ATE)
- Industrial Process Controls
- Arbitrary Function Generators
- Avionics Equipment
- Minimum Component Count Analog Systems
- Digital Offset/Gain Adjustment
- SONET Applications

Functional Diagram appears at end of data sheet.

Features

- ◆ Full 13-Bit Performance without Adjustments
- ◆ Eight DACs in a Single Package
- ◆ Buffered Voltage Outputs
- ◆ Unipolar or Bipolar Voltage Swing to $\pm 10V$
- ◆ 31 μs Output Settling Time
- ◆ Low Power Consumption: 8mA (typ)
- ◆ Small 44-Pin MQFP Package
- ◆ Double-Buffered Digital Inputs
- ◆ Asynchronous Load Updates All DACs Simultaneously
- ◆ Asynchronous CLR Forces All DACs to DUTGND__ Potential

Ordering Information

PART	TEMP RANGE	PIN-PACKAGE	INL (LSB)
MX7839AS	-40°C to +85°C	44 MQFP	± 2

Pin Configuration

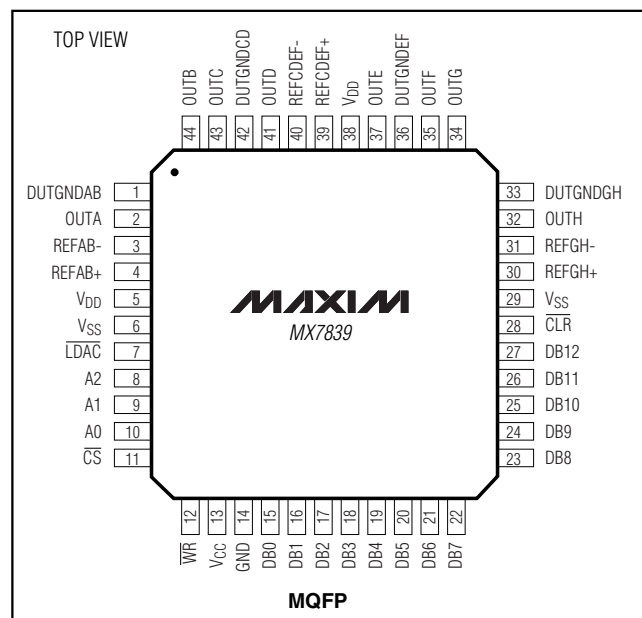

Octal, 13-Bit Voltage-Output DAC with Parallel Interface

ABSOLUTE MAXIMUM RATINGS

V _{DD} to GND	-0.3V to +17V	Maximum Current into Any Signal Pin	±50mA
V _{SS} to GND	-17V to +0.3V	OUT_ Short-Circuit Duration to V _{DD} , V _{SS} , and GND	1s
V _{CC} to GND	-0.3V to +6V	Continuous Power Dissipation (T _A = +70°C)	
A_, DB_, WR, CS, LDAC, CLR to GND	+0.3V to (V _{CC} + 0.3V)	44-Pin MQFP (derate 11.1mW/°C above +70°C).....	870mW
REF_+_, REF_-,		Operating Temperature Range	-40°C to +85°C
DUTGND_	(V _{SS} - 0.3V) to (V _{DD} + 0.3V)	Junction Temperature	+150°C
OUT_	V _{DD} to V _{SS}	Storage Temperature Range	-65°C to +150°C
Maximum Current into REF_+, DUTGND_	±10mA	Lead Temperature (soldering, 10s)	+300°C

Stresses beyond those listed under "Absolute Maximum Ratings" may cause permanent damage to the device. These are stress ratings only, and functional operation of the device at these or any other conditions beyond those indicated in the operational sections of the specifications is not implied. Exposure to absolute maximum rating conditions for extended periods may affect device reliability.

ELECTRICAL CHARACTERISTICS

(V_{DD} = +15V ±5%, V_{SS} = -15V ±5%, V_{CC} = +5V ±5%, V_{GND} = V_{DUTGND_} = 0, V_{REF_+} = +5V, V_{REF_-} = -5V, R_L = 5kΩ, C_L = 50pF, T_A = T_{MIN} to T_{MAX}, unless otherwise noted. Typical values are at T_A = +25°C.)

PARAMETER	SYMBOL	CONDITIONS	MIN	TYP	MAX	UNITS
STATIC PERFORMANCE (ANALOG SECTION)						
Resolution	N		13			Bits
Relative Accuracy	INL				±2	LSB
Differential Nonlinearity	DNL	Guaranteed monotonic			±0.9	LSB
Zero-Scale Error				±2	±8	LSB
Full-Scale Error				±1	±4	LSB
Gain Error				±1		LSB
Gain Temperature Coefficient		(Note 1)		0.5	10	ppm FSR/°C
DC Crosstalk		(Note 1)		75	120	μV
REFERENCE INPUTS						
Input Resistance				100		MΩ
Input Current					±1	μA
REF_+ Input Range			0		5	V
REF_- Input Range			-5		0	V
(REF_+) - (REF_-) Range			2		10	V
ANALOG OUTPUTS						
Output Voltage Swing			-10		+10	kΩ
Resistive Load to GND			5			kΩ
Capacitive Load to GND					50	pF
DC Output Impedance		(Note 1)			0.5	Ω

Octal, 13-Bit Voltage-Output DAC with Parallel Interface

MX7839

ELECTRICAL CHARACTERISTICS (continued)

($V_{DD} = +15V \pm 5\%$, $V_{SS} = -15V \pm 5\%$, $V_{CC} = +5V \pm 5\%$, $V_{GND} = V_{DUTGND_} = 0$, $V_{REF_+} = +5V$, $V_{REF_} = -5V$, $R_L = 5k\Omega$, $C_L = 50pF$, $T_A = T_{MIN}$ to T_{MAX} , unless otherwise noted. Typical values are at $T_A = +25^\circ C$.)

PARAMETER	SYMBOL	CONDITIONS	MIN	TYP	MAX	UNITS
DUTGND_ CHARACTERISTICS						
Input Impedance per DAC				60		k Ω
Maximum Input Current per DAC				± 300		μA
Input Range			-2		+2	V
DIGITAL INPUTS						
Input Voltage High	V_{IH}		2.4			V
Input Voltage Low	V_{IL}				0.8	V
Input Capacitance	C_{IN}	(Note 1)			10	pF
Input Current	I_{IN}	Digital inputs = 0V or V_{CC}		± 1	± 10	μA
POWER SUPPLIES						
V_{DD} Analog Power-Supply Range	V_{DD}		14.25		15.75	V
V_{SS} Analog Power-Supply Range	V_{SS}		-14.25		-15.75	V
V_{CC} Digital Power Supply	V_{CC}		4.75		5.25	V
Positive Supply Current	I_{DD}	$R_L = \infty$		8	10	mA
Negative Supply Current	I_{SS}	$R_L = \infty$		8	10	mA
Digital Supply Current	I_{CC}	Digital inputs = 0V or V_{CC} (Note 2)			0.5	mA
PSRR, $\Delta V_{OUT} / \Delta V_{DD}$		$V_{DD} = +15V \pm 5\%$		90		dB
PSRR, $\Delta V_{OUT} / \Delta V_{SS}$		$V_{SS} = -15V \pm 5\%$		90		dB

INTERFACE TIMING CHARACTERISTICS

($V_{DD} = +15V \pm 5\%$, $V_{SS} = -15V \pm 5\%$, $V_{CC} = +5V \pm 5\%$, $V_{GND} = V_{DUTGND_} = 0$, $V_{REF_+} = +5V$, $V_{REF_} = -5V$, Figure 2a, $T_A = T_{MIN}$ to T_{MAX} , unless otherwise noted.)

PARAMETER	SYMBOL	CONDITIONS	MIN	TYP	MAX	UNITS
\overline{CS} Pulse Width Low	t_1		50			ns
\overline{WR} Pulse Width Low	t_2		50			ns
\overline{LDAC} Pulse Width Low	t_3		50			ns
\overline{CS} Low to \overline{WR} Low	t_4		0			ns
\overline{CS} High to \overline{WR} High	t_5		0			ns
Data Valid to \overline{WR} Setup	t_6		20			ns
Data Valid to \overline{WR} Hold	t_7		0			ns
Address Valid to \overline{WR} Setup	t_8		15			ns
Address Valid to \overline{WR} Hold	t_9		0			ns
\overline{CLR} Pulse-Activation Time	t_{10}	Figure 2b			300	ns

Octal, 13-Bit Voltage-Output DAC with Parallel Interface

DYNAMIC CHARACTERISTICS

($V_{DD} = +15V \pm 5\%$, $V_{SS} = -15V \pm 5\%$, $V_{CC} = +5V \pm 5\%$, $V_{GND} = V_{DUTGND_} = 0$, $V_{REF_+} = +5V$, $V_{REF_} = -5V$, $R_L = 5k\Omega$, $C_L = 50pF$, $T_A = T_{MIN}$ to T_{MAX} , unless otherwise noted. Typical values are at $T_A = +25^\circ C$.)

PARAMETER	SYMBOL	CONDITIONS	MIN	TYP	MAX	UNITS
Output Settling Time		To ± 0.5 LSB of full scale		31		μs
Output Slew Rate				0.7		$V/\mu s$
Digital Feedthrough		(Note 3)		0.1		nV-s
Digital Crosstalk		(Note 4)		0.2		nV-s
Digital-to-Analog Glitch Impulse				230		nV-s
DAC-to-DAC Crosstalk				40		nV-s
Channel-to-Channel Isolation				99		dB
Output Noise Spectral Density		$V_{REF+} = V_{REF-} = 0V$		200		nV/\sqrt{Hz}

Note 1: Guaranteed by design. Not production tested.

Note 2: All digital inputs ($DB_$, $A_$, WR , CS , $LDAC$, and CLR) at GND or V_{CC} potential.

Note 3: All digital inputs ($DB_$, $A_$, WR , CS , $LDAC$, and CLR) at +0.8V or +2.4V.

Note 4: All digital inputs ($DB0$ to $DB12$) transition from GND to V_{CC} with $WR = V_{CC}$.

Typical Operating Characteristics

($V_{DD} = +15V \pm 5\%$, $V_{SS} = -15V \pm 5\%$, $V_{CC} = +5V \pm 5\%$, $V_{GND} = V_{DUTGND_} = 0$, $V_{REF_+} = +5V$, $V_{REF_} = -5V$, $T_A = +25^\circ C$, unless otherwise noted.)

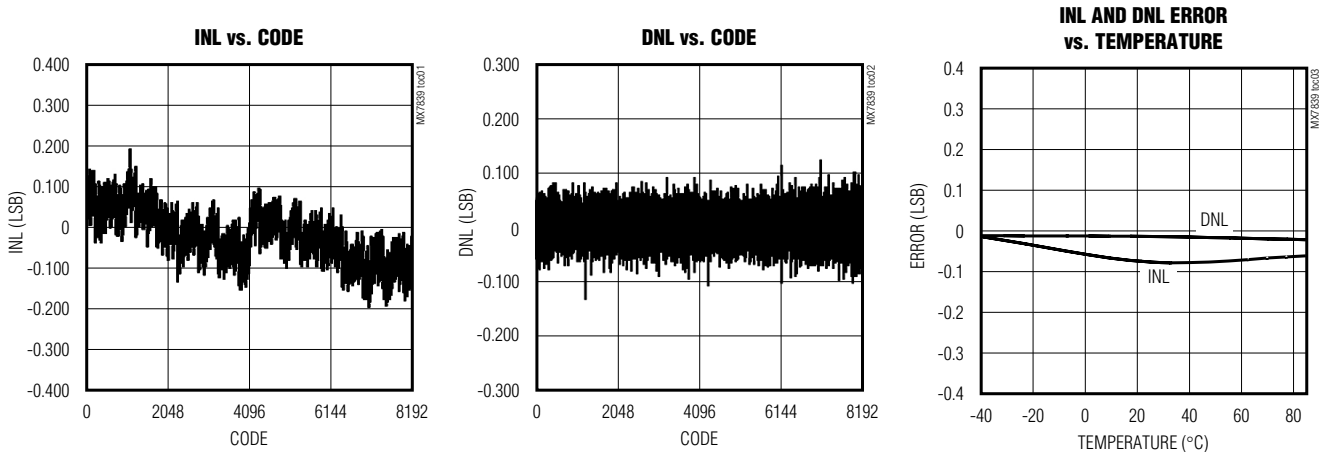

Octal, 13-Bit Voltage-Output DAC with Parallel Interface

MX7839

Typical Operating Characteristics (continued)

($V_{DD} = +15V \pm 5\%$, $V_{SS} = -15V \pm 5\%$, $V_{CC} = +5V \pm 5\%$, $V_{GND} = V_{DUTGND} = 0$, $V_{REF_+} = +5V$, $V_{REF_ -} = -5V$, $T_A = +25^\circ C$, unless otherwise noted.)

ZERO-SCALE AND FULL-SCALE ERROR vs. TEMPERATURE

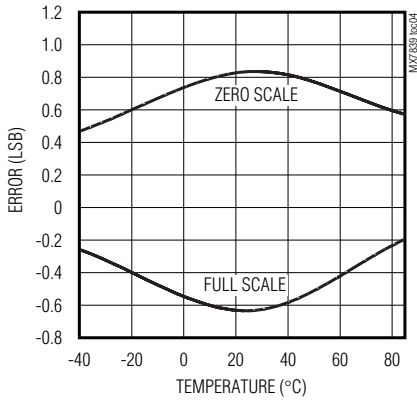

I_{DD} AND I_{SS} vs. TEMPERATURE

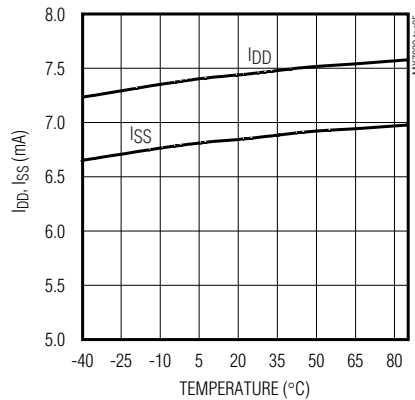

DIGITAL SUPPLY CURRENT vs. TEMPERATURE

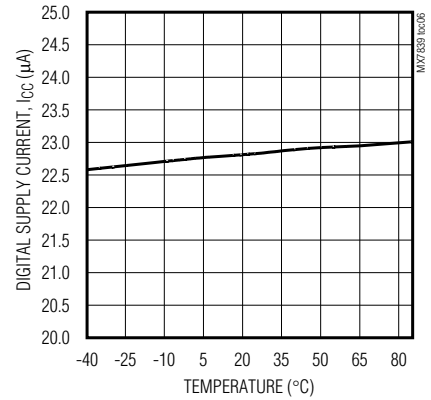

REFERENCE INPUT FREQUENCY RESPONSE

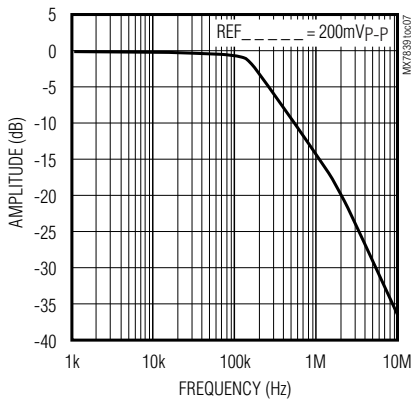

SETTLING TIME vs. CAPACITIVE LOAD

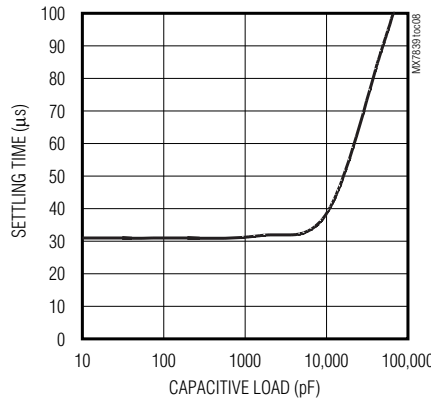

LARGE-SIGNAL STEP RESPONSE

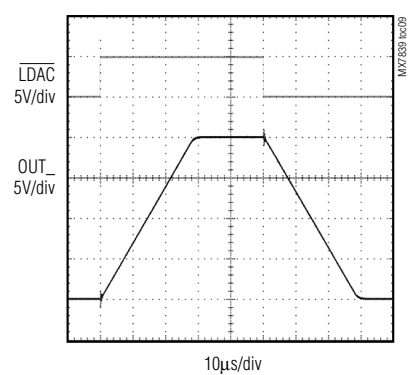

POSITIVE SETTLING TIME

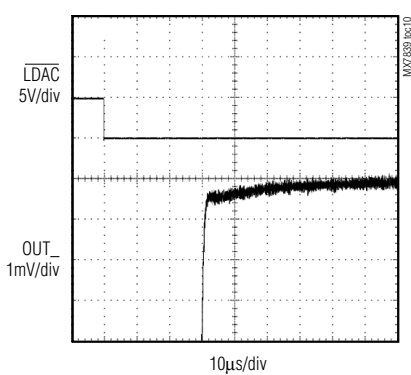

NEGATIVE SETTLING TIME

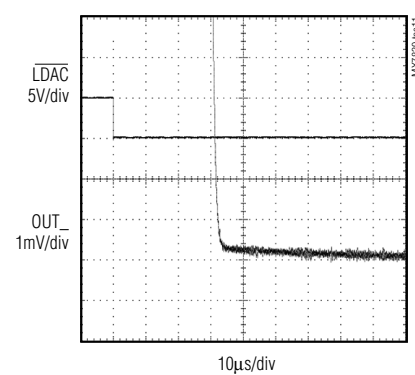

NOISE VOLTAGE DENSITY vs. FREQUENCY

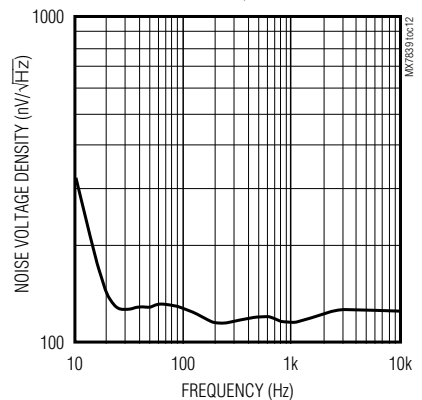

Octal, 13-Bit Voltage-Output DAC with Parallel Interface

Typical Operating Characteristics (continued)

($V_{DD} = +15V \pm 5\%$, $V_{SS} = -15V \pm 5\%$, $V_{CC} = +5V \pm 5\%$, $V_{GND} = V_{DUTGND_} = 0$, $V_{REF_+} = +5V$, $V_{REF_ -} = -5V$, $T_A = +25^\circ C$, unless otherwise noted.)

MAJOR CARRY GLITCH IMPULSE (0x0FFF-0x1000)

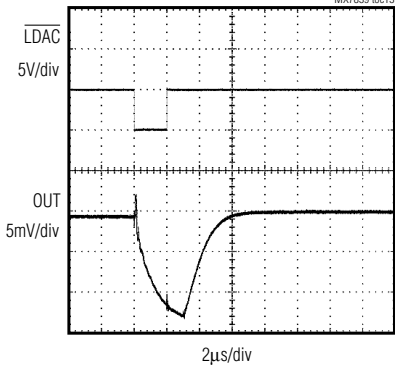

MAJOR CARRY GLITCH IMPULSE (0x1000-0x0FFF)

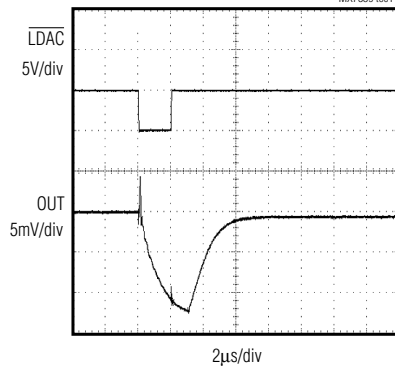

GAIN ERROR vs. VREF (VREF+ - VREF-)

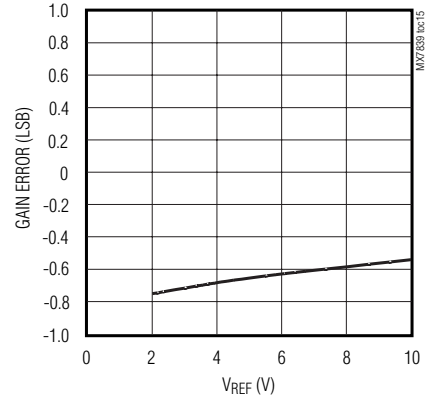

DNL (MAX, MIN) vs. VREF (VREF+ - VREF-)

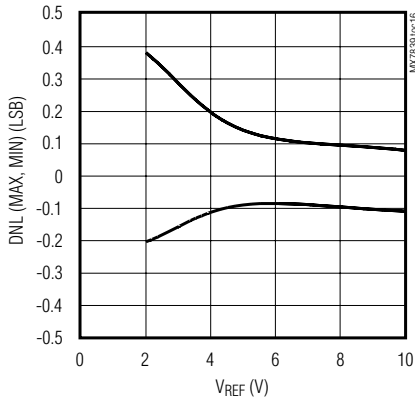

ZERO-SCALE ERROR vs. VREF (VREF+ - VREF-)

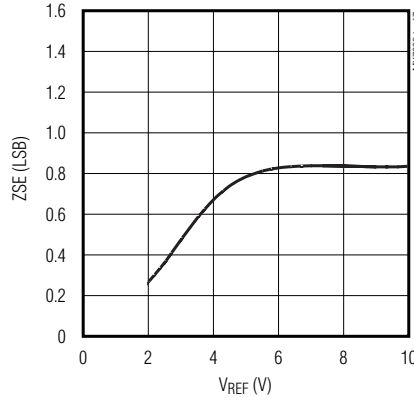

FULL-SCALE ERROR vs. VREF (VREF+ - VREF-)

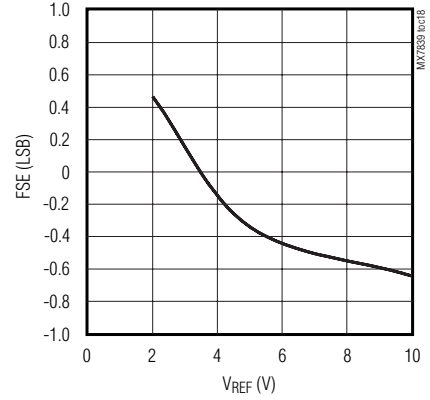

INL (MAX, MIN) vs. VREF (VREF+ - VREF-)

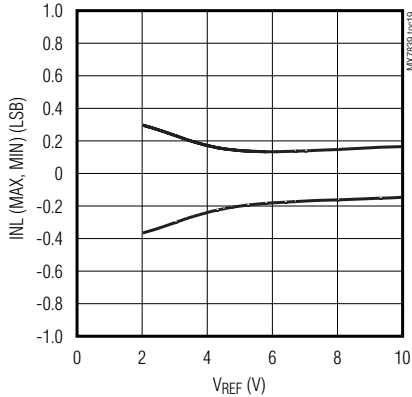

SHORT-CIRCUIT CURRENT vs. TEMPERATURE

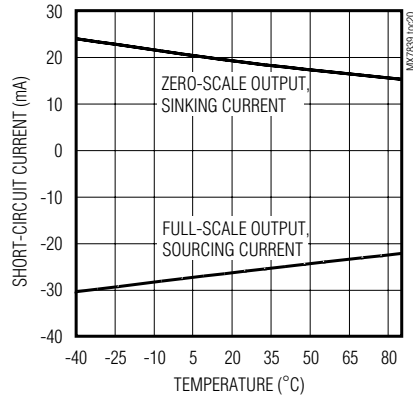

Octal, 13-Bit Voltage-Output DAC with Parallel Interface

Pin Description

MX7839

PIN	NAME	FUNCTION
1	DUTGNDAB	Device Sense Ground Input for OUTA and OUTB. In normal operation, OUTA and OUTB are referenced to DUTGNDAB. When $\overline{\text{CLR}}$ is low, OUTA and OUTB are forced to the potential on DUTGNDAB.
2	OUTA	DAC A Buffered Output Voltage
3	REFAB-	Negative Reference Input for DACs A and B
4	REFAB+	Positive Reference Input for DACs A and B
5, 38	V _{DD}	Positive Analog Power Supply. Normally set to +15V. Connect both pins to the supply voltage. See the <i>Power Supplies, Grounding, and Bypassing</i> section for bypass requirements.
6, 29	V _{SS}	Negative Analog Power Supply. Normally set to -15V. See the <i>Power Supplies, Grounding, and Bypassing</i> section for bypass requirements.
7	$\overline{\text{LDAC}}$	Load Input. Drive this asynchronous input low to transfer the contents of the input latches to their respective DAC latches. DAC latches are transparent when $\overline{\text{LDAC}}$ is low and latched when $\overline{\text{LDAC}}$ is high.
8	A2	Address Bit 2 (MSB)
9	A1	Address Bit 1
10	A0	Address Bit 0 (LSB)
11	$\overline{\text{CS}}$	Chip Select. Active-low input.
12	$\overline{\text{WR}}$	Write Input. Active-low strobe for conventional memory write sequence. Input data latches are transparent when $\overline{\text{WR}}$ and $\overline{\text{CS}}$ are both low. $\overline{\text{WR}}$ latches data into the DAC input latch selected by A2, A1, A0 on the rising edge of $\overline{\text{CS}}$.
13	V _{CC}	Digital Power Supply. Normally set to +5V. See the <i>Power Supplies, Grounding, and Bypassing</i> section for bypass requirements.
14	GND	Ground
15–27	DB0–DB12	Data Bits 0–12. Offset binary coding.
28	$\overline{\text{CLR}}$	Clear Input. Drive $\overline{\text{CLR}}$ low to force all DAC outputs to the voltage on their respective DUTGND _ _ . Does not affect the status of internal registers. All DACs return to their previous levels when $\overline{\text{CLR}}$ goes high.
30	REFGH+	Positive Reference Input for DACs G and H
31	REFGH-	Negative Reference Input for DACs G and H

Octal, 13-Bit Voltage-Output DAC with Parallel Interface

Pin Description (continued)

PIN	NAME	FUNCTION
32	OUTH	DAC H Buffered Output Voltage
33	DUTGNDGH	Device Sense Ground Input for OUTG and OUTH. In normal operation, OUTG and OUTH are referenced to DUTGNDGH. When CLR is low, OUTG and OUTH are forced to the potential on DUTGNDGH.
34	OUTG	DAC G Buffered Output Voltage
35	OUTF	DAC F Buffered Output Voltage
36	DUTGNDEF	Device Sense Ground Input for OUTE and OUTF. In normal operation, OUTE and OUTF are referenced to DUTGNDEF. When CLR is low, OUTE and OUTF are forced to the potential on DUTGNDEF.
37	OUTE	DAC E Buffered Output Voltage
39	REFCDEF+	Positive Reference Input for DACs C, D, E, and F
40	REFCDEF-	Negative Reference Input for DACs C, D, E, and F
41	OUTD	DAC D Buffered Output Voltage
42	DUTGNDCD	Device Sense Ground Input for OUTC and OUTD. In normal operation, OUTC and OUTD are referenced to DUTGNDCD. When CLR is low, OUTC and OUTD are forced to the potential on DUTGNDCD.
43	OUTC	DAC C Buffered Output Voltage
44	OUTB	DAC B Buffered Output Voltage

Octal, 13-Bit Voltage-Output DAC with Parallel Interface

Detailed Description

Analog Section

The MX7839 contains eight 13-bit voltage-output DACs. These DACs are inverted R-2R ladder networks that convert 13-bit digital inputs into equivalent analog output voltages, in proportion to the applied reference voltages (Figure 1). The MX7839 has three positive reference inputs (REF_ ___+) and three negative reference inputs (REF_ ___-). The difference from REF_ ___+ to REF_ ___-, multiplied by two, sets the DAC output span.

In addition to the differential reference inputs, the MX7839 has four analog-ground input pins (DUTGND_ _). When CLR is high (unasserted), the voltage on DUTGND_ _ offsets the DAC output voltage range. If CLR is asserted, the output amplifier is forced to the voltage present on DUTGND_ _.

Reference and DUTGND Inputs

All of the MX7839's reference inputs are buffered with precision amplifiers. This allows the flexibility of using resistive dividers to set the reference voltages. Because of the relatively high multiplying bandwidth of the reference input (188kHz), any signal present on the reference pin within this bandwidth is replicated on the DAC output.

The DUTGND pins of the MX7839 are connected to the negative source resistor (nominally 115kΩ) of the output amplifier. The DUTGND pins are typically connected directly to analog ground. Each of these pins has an input current that varies with the DAC digital code. If the DUTGND pins are driven by external circuitry, budget ±200μA per DAC for load current.

Output-Buffer Amplifiers

The MX7839's voltage outputs are internally buffered by precision gain-of-two amplifiers with a typical slew rate of 1V/μs. With a full-scale transition at its output, the typical settling time to ±1/2 LSB is 31μs. This settling time does not significantly vary with capacitive loads less than 10,000pF.

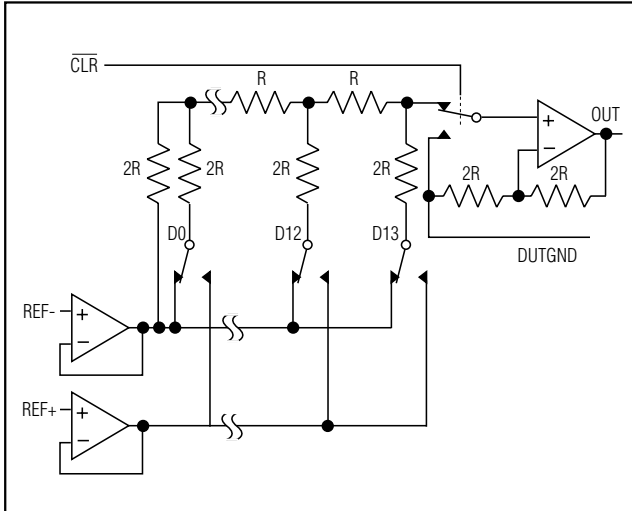

Figure 1. DAC Simplified Circuit

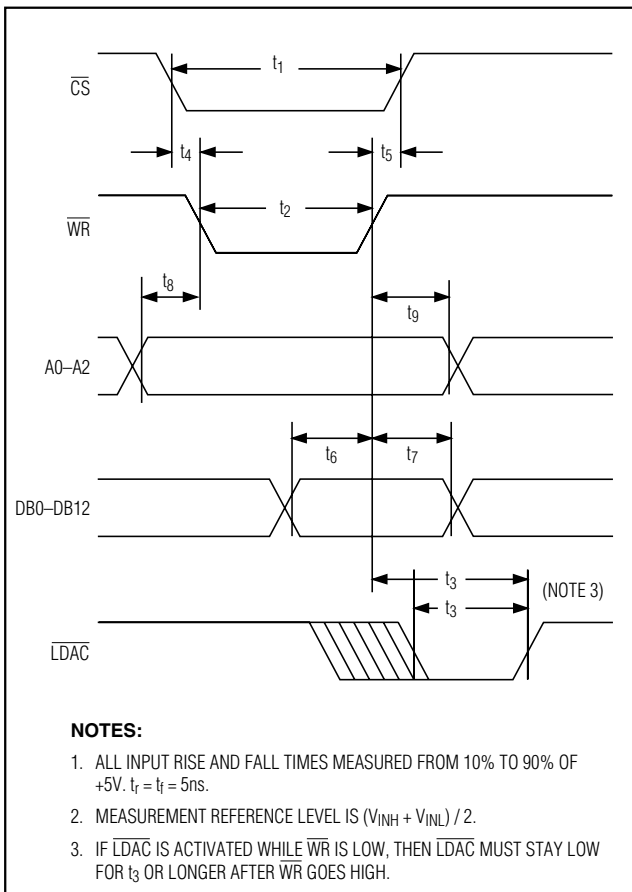

Figure 2a. Digital Timing Diagram

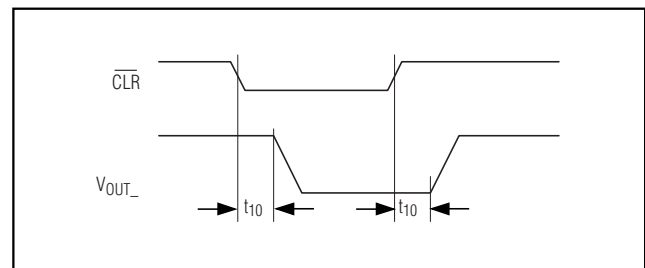

Figure 2b. Digital Timing Diagram

Octal, 13-Bit Voltage-Output DAC with Parallel Interface

Output Deglitching Circuit

The MX7839's internal connection from the DAC ladder to the output amplifier contains special deglitch circuitry. This glitch/deglitch circuitry is enabled on the falling edge of $\overline{\text{LDAC}}$ to remove the glitch from the R-2R DAC. This enables the MX7839 to exhibit a fraction of the glitch impulse energy of parts without the deglitching circuit.

Digital Inputs and Interface Logic

All digital inputs are compatible with both TTL and CMOS logic. The MX7839 interfaces with microprocessors using a data bus at least 13 bits wide. The interface is double buffered, allowing simultaneous updating of all DACs. There are two latches for each DAC (see the *Functional Diagram*): an input latch that receives data from the data bus, and a DAC latch that receives data from the input latch. Address lines A0, A1, and A2 select which DAC's input latch receives data from the data bus as shown in Table 1. Both the

Table 1. MX7839 DAC Addressing

A2	A1	A0	FUNCTION
0	0	0	DAC A input latch
0	0	1	DAC B input latch
0	1	0	DAC C input latch
0	1	1	DAC D input latch
1	0	0	DAC E input latch
1	0	1	DAC F input latch
1	1	0	DAC G input latch
1	1	1	DAC H input latch

Table 2. Interface Truth Table

$\overline{\text{CLR}}$	$\overline{\text{LD}}$	$\overline{\text{WR}}$	$\overline{\text{CS}}$	FUNCTION
X	X	0	0	Input register transparent
X	X	X	1	Input register latched
X	X	1	X	Input register latched
X	0	X	X	DAC register transparent
X	1	X	X	DAC register latched
0	X	X	X	Outputs of DACs at DUTGND_ _
1	1	X	X	Outputs of DACs set to voltage defined by the DAC register, the references, and the corresponding DUTGND_ _

X = Don't care.

input latches and the DAC latches are transparent when $\overline{\text{CS}}$, $\overline{\text{WR}}$, and $\overline{\text{LDAC}}$ are all low. Any change of DB0–DB12 during this condition appears at the output instantly. Transfer data from the input latches to the DAC latches by asserting the asynchronous $\overline{\text{LDAC}}$ signal. Each DAC's analog output reflects the data held in its DAC latch. All control inputs are level triggered. Table 2 is an interface truth table.

Input Write Cycle

Data can be latched or transferred directly to the DAC. $\overline{\text{CS}}$ and $\overline{\text{WR}}$ control the input latch, and $\overline{\text{LDAC}}$ transfers information from the input latch to the DAC latch. The input latch is transparent when $\overline{\text{CS}}$ and $\overline{\text{WR}}$ are low, and the DAC latch is transparent when $\overline{\text{LDAC}}$ is low. The address lines (A0, A1, A2) must be valid for the duration that $\overline{\text{CS}}$ and $\overline{\text{WR}}$ are low (Figure 2a) to prevent data from being inadvertently written to the wrong DAC. Data is latched within the input latch when either $\overline{\text{CS}}$ or $\overline{\text{WR}}$ is high.

Loading the DACs

Taking $\overline{\text{LDAC}}$ high latches data into the DAC latches. If $\overline{\text{LDAC}}$ is brought low when $\overline{\text{WR}}$ and $\overline{\text{CS}}$ are low, the DAC addressed by A0, A1, and A2 is directly controlled by the data on DB0–DB12. This allows the maximum digital update rate; however, it is sensitive to any glitches or skew in the input data stream.

Asynchronous Clear

The MX7839 has an asynchronous clear pin ($\overline{\text{CLR}}$) that, when asserted, sets all DAC outputs to the voltage present on their respective DUTGND pins. Deassert $\overline{\text{CLR}}$ to return the DAC output to its previous voltage. Note that $\overline{\text{CLR}}$ does not clear any of the internal digital registers. See Figure 2b.

Applications Information

Multiplying Operation

The MX7839 can be used for multiplying applications. Its reference accepts both DC and AC signals. Since the reference inputs are unipolar, the multiplying operation is limited to two quadrants. See the graphs in the *Typical Operating Characteristics* for dynamic performance of the DACs and output buffers.

Digital Code and Analog Output Voltage

The MX7839 uses offset binary coding. A 13-bit two's complement code is converted to a 13-bit offset binary code by adding $2^{12} = 4096$.

Octal, 13-Bit Voltage-Output DAC with Parallel Interface

Table 3. Analog Voltage vs. Digital Code

INPUT CODE	OUTPUT VOLTAGE (V)
1 1111 1111 1111	+9.997558
1 0000 0000 0000	0
0 1001 1101 1001	-3.845215
0 0000 0000 0001	-9.997558
0 0000 0000 0000	-10

Note: Output voltage is based on REF+ = +5V, REF- = -5V, and DUTGND = 0V.

Output Voltage Range

For typical operation, connect DUTGND to signal ground, VREF+ to +5V, and VREF- to -5V. Table 3 shows the relationship between digital code and output voltage.

The DAC digital code controls each leg of the 13-bit R-2R ladder. A code of 0x0 connects all legs of the ladder to REF-, corresponding to a DAC output voltage (VDAC) equal to REF-. A code of 0x1FFF connects all legs of the ladder to REF+, corresponding to a VDAC approximately equal to REF+.

The output amplifier multiplies VDAC by 2, yielding an output voltage range of 2 × REF- to 2 × REF+ (Figure 1). Further manipulation of the output voltage span is accomplished by offsetting DUTGND. The output voltage of the MX7839 is described by the following equation:

$$V_{OUT} = 2 \left[(V_{REF+} - V_{REF-}) \frac{DATA}{2^{13}} + V_{REF-} \right] - V_{DUTGND}$$

where DATA is the numeric value of the DAC's binary input code, and DATA ranges from 0 to 8191 (2¹³ - 1). The resolution of the MX7839, defined as 1 LSB, is described by the following equation:

$$LSB = \frac{2(V_{REF+} - V_{REF-})}{2^{13}}$$

Reference Selection

Because the MX7839 has precision buffers on its reference inputs, the requirements for interfacing to these inputs are minimal. Select a low-drift, low-noise reference within the recommended REF+ and REF- voltage ranges. The MX7839 does not require bypass capacitors on its reference inputs. Add capacitors only if the reference voltage source requires them to meet system specifications.

Minimizing Output Glitch

The MX7839's internal deglitch circuitry is enabled on the falling edge of LDAC. Therefore, to achieve optimum performance, drive LDAC low after the inputs are either latched or steady state. This is best accomplished by having the falling edge of LDAC occur at least 50ns after the rising edge of CS.

Power Supplies, Grounding, and Bypassing

For optimum performance, use a multilayer PC board with an unbroken analog ground. For normal operation, connect the four DUTGND pins directly to the ground plane. Avoid sharing the connections of these sensitive pins with other ground traces.

As with any sensitive data-acquisition system, connect the digital and analog ground planes together at a single point, preferably directly underneath the MX7839. Avoid routing digital signals underneath the MX7839 to minimize their coupling into the IC.

For normal operation, bypass VDD and VSS with 0.1µF ceramic chip capacitors to the analog ground plane. To enhance transient response and capacitive drive capability, add 10µF tantalum capacitors in parallel with the ceramic capacitors. Note, however, that the MX7839 does not require the additional capacitance for stability. Bypass VCC with a 0.1µF ceramic chip capacitor to the digital ground plane.

Octal, 13-Bit Voltage-Output DAC with Parallel Interface

Power-Supply Sequencing

To guarantee proper operation of the MX7839, ensure that power is applied to V_{DD} before V_{SS} and V_{CC} . Also ensure that V_{SS} is never more than 300mV above ground. To prevent this situation, connect a Schottky diode between V_{SS} and the analog ground plane, as shown in Figure 3. Do not power up the logic input pins before establishing the supply voltages. If this is not possible and the digital lines can drive more than 10mA, place current-limiting resistors (e.g., 470 Ω) in series with the logic pins.

Driving Capacitive Loads

The MX7839 typically drives capacitive loads up to 0.01 μ F without a series output resistor. However, whenever driving high capacitive loads, it is prudent to use a 220 Ω series resistor between the MX7839 output and the capacitive load.

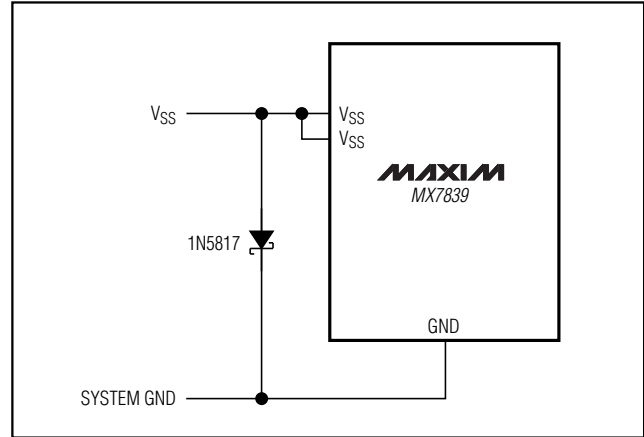

Figure 3. Schottky Diode Between V_{SS} and GND

Chip Information

TRANSISTOR COUNT: 13,225

PROCESS: BiCMOS

Octal, 13-Bit Voltage-Output DAC with Parallel Interface

Functional Diagram

MX7839

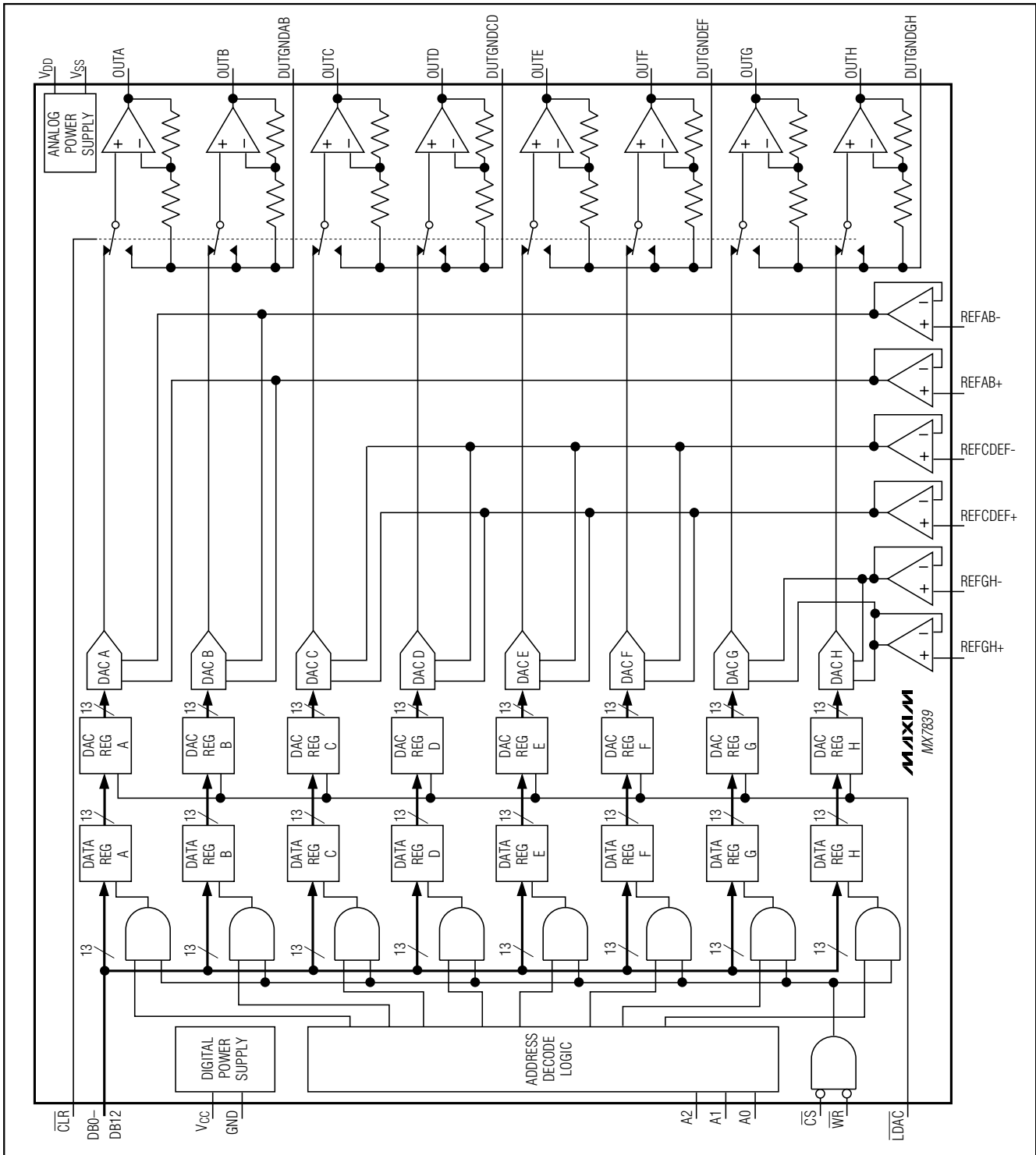

Octal, 13-Bit Voltage-Output DAC with Parallel Interface

Package Information

(The package drawing(s) in this data sheet may not reflect the most current specifications. For the latest package outline information go to www.maxim-ic.com/packages.)

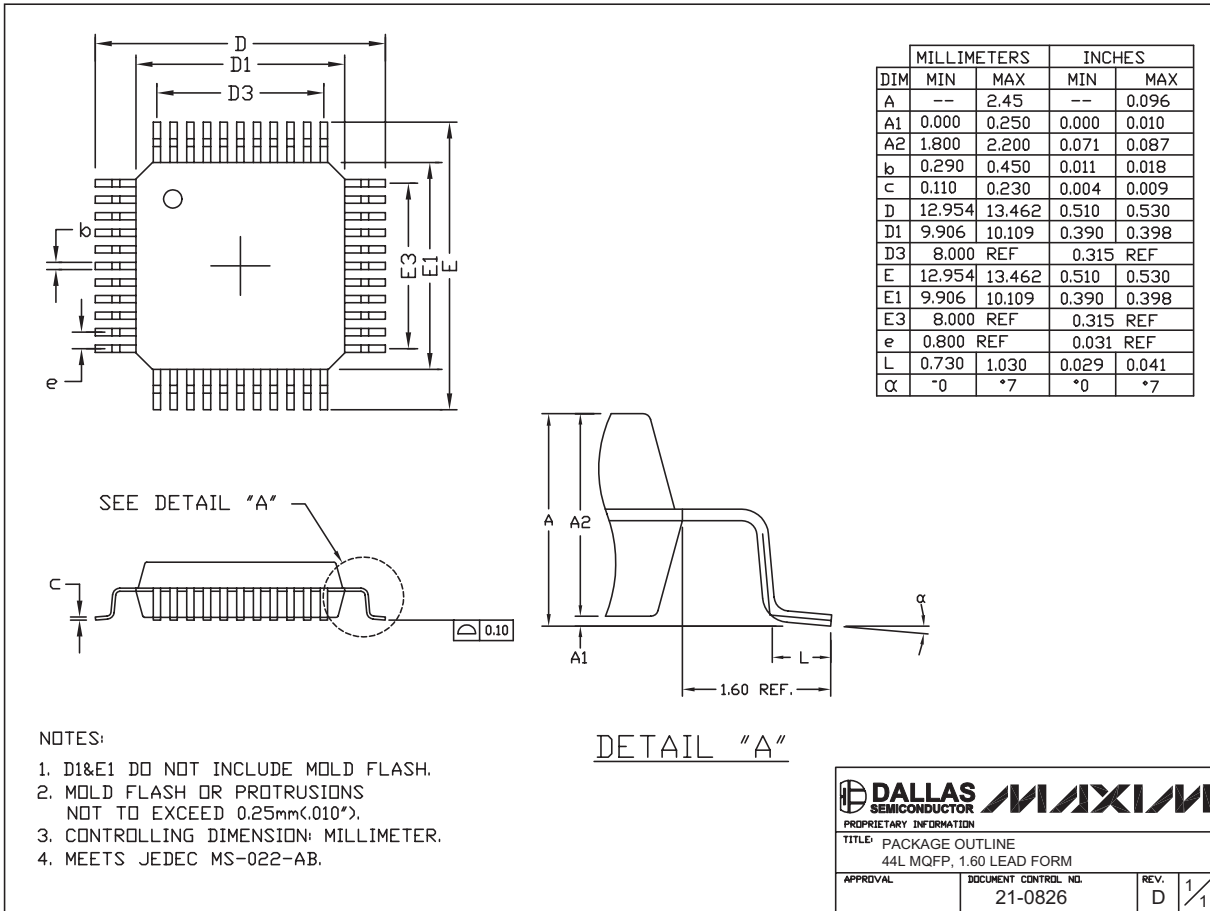

MQFP44-EPS

Maxim cannot assume responsibility for use of any circuitry other than circuitry entirely embodied in a Maxim product. No circuit patent licenses are implied. Maxim reserves the right to change the circuitry and specifications without notice at any time.

14 **Maxim Integrated Products, 120 San Gabriel Drive, Sunnyvale, CA 94086 408-737-7600**