

LMP2231 Single Micropower, 1.8V, Precision Operational Amplifier with CMOS Inputs

General Description

The LMP2231 is a single micropower precision amplifier designed for battery powered applications. The 1.8V to 5.0V guaranteed supply voltage range and quiescent power consumption of only 18 μW extend the battery life in portable battery operated systems. The LMP2231 is part of the LMP® precision amplifier family. The high impedance CMOS input makes it ideal for instrumentation and other sensor interface applications.

The LMP2231 has a maximum offset of 150 μV and maximum offset voltage drift of only 0.4 $\mu\text{V}/^\circ\text{C}$ along with low bias current of only ± 20 fA. These precise specifications make the LMP2231 a great choice for maintaining system accuracy and long term stability.

The LMP2231 has a rail-to-rail output that swings 15 mV from the supply voltage, which increases system dynamic range. The common mode input voltage range extends 200 mV below the negative supply, thus the LMP2231 is ideal for use in single supply applications with ground sensing.

The LMP2231 is offered in 5-Pin SOT23 and 8-pin SOIC packages.

The dual and quad versions of this product are also available. The dual, LMP2232 is offered in 8-pin SOIC and MSOP. The quad, LMP2234 is offered in 14-pin SOIC and TSSOP.

Features

(For $V_S = 5\text{V}$, Typical unless otherwise noted)

■ Supply current	10 μA
■ Operating voltage range	1.6V to 5.5V
■ Low TCV_{OS}	± 0.4 $\mu\text{V}/^\circ\text{C}$ (max)
■ V_{OS}	± 150 μV (max)
■ Input bias current	20 fA
■ PSRR	120 dB
■ CMRR	97 dB
■ Open loop gain	120 dB
■ Gain bandwidth product	130 kHz
■ Slew rate	58 V/ms
■ Input voltage noise, $f = 1$ kHz	60 nV/ $\sqrt{\text{Hz}}$
■ Temperature range	-40°C to 125°C

Applications

- Precision instrumentation amplifiers
- Battery powered medical instrumentation
- High Impedance Sensors
- Strain gauge bridge amplifier
- Thermocouple amplifiers

Typical Application

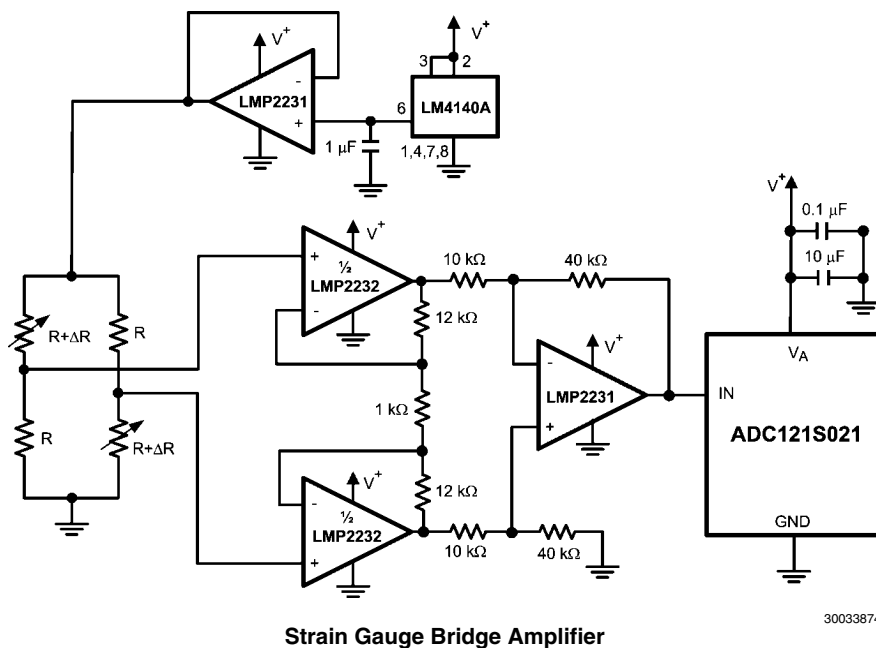

LMP® is a registered trademark of National Semiconductor Corporation.

Absolute Maximum Ratings (Note 1)

If Military/Aerospace specified devices are required, please contact the National Semiconductor Sales Office/Distributors for availability and specifications.

ESD Tolerance (Note 2)	
Human Body Model	2000V
Machine Model	100V
Differential Input Voltage	±300 mV
Supply Voltage ($V_S = V^+ - V^-$)	6V
Voltage on Input/Output Pins	$V^+ + 0.3V, V^- - 0.3V$
Storage Temperature Range	-65°C to 150°C

Junction Temperature (Note 3)	150°C
Mounting Temperature	
Infrared or Convection (20 sec.)	+235°C

Operating Ratings (Note 1)

Operating Temperature Range (Note 3)	-40°C to 125°C
Supply Voltage ($V_S = V^+ - V^-$)	1.6V to 5.5V
Package Thermal Resistance (θ_{JA}) (Note 3)	
5-Pin SOT23	160.6 °C/W
8-Pin SOIC	116.2 °C/W

5V DC Electrical Characteristics (Note 4) Unless otherwise specified, all limits guaranteed for $T_A = 25^\circ\text{C}$, $V^+ = 5V$, $V^- = 0V$, $V_{CM} = V_O = V^+/2$, and $R_L > 1\text{ M}\Omega$. **Boldface** limits apply at the temperature extremes.

Symbol	Parameter	Conditions	Min (Note 6)	Typ (Note 5)	Max (Note 6)	Units
V_{OS}	Input Offset Voltage			±10	±150 ±230	µV
TCV_{OS}	Input Offset Voltage Drift	LMP2231A		±0.3	±0.4	µV/°C
		LMP2231B		±0.3	±2.5	
I_{BIAS}	Input Bias Current			0.02	±1 ±50	pA
I_{OS}	Input Offset Current			5		fA
CMRR	Common Mode Rejection Ratio	$0V \leq V_{CM} \leq 4V$	81 80	97		dB
PSRR	Power Supply Rejection Ratio	$1.6V \leq V^+ \leq 5.5V$ $V^- = 0V, V_{CM} = 0V$	83 83	120		dB
CMVR	Common Mode Voltage Range	CMRR ≥ 80 dB CMRR ≥ 79 dB	-0.2 -0.2		4.2 4.2	V
A_{VOL}	Large Signal Voltage Gain	$V_O = 0.3V$ to $4.7V$ $R_L = 10\text{ k}\Omega$ to $V^+/2$	110 108	120		dB
V_O	Output Swing High	$R_L = 10\text{ k}\Omega$ to $V^+/2$ $V_{IN}(\text{diff}) = 100\text{ mV}$		17	50 50	mV from either rail
	Output Swing Low	$R_L = 10\text{ k}\Omega$ to $V^+/2$ $V_{IN}(\text{diff}) = -100\text{ mV}$		17	50 50	
I_O	Output Current (Note 7)	Sourcing, V_O to V^- $V_{IN}(\text{diff}) = 100\text{ mV}$	27 19	30		mA
		Sinking, V_O to V^+ $V_{IN}(\text{diff}) = -100\text{ mV}$	17 12	22		
I_S	Supply Current			10	16 18	µA

5V AC Electrical Characteristics (Note 4) Unless otherwise specified, all limits guaranteed for $T_A = 25^\circ\text{C}$, $V^+ = 5V$, $V^- = 0V$, $V_{CM} = V_O = V^+/2$, and $R_L > 1\text{ M}\Omega$. **Boldface** limits apply at the temperature extremes.

Symbol	Parameter	Conditions	Min (Note 6)	Typ (Note 5)	Max (Note 6)	Units
GBW	Gain-Bandwidth Product	$C_L = 20\text{ pF}, R_L = 10\text{ k}\Omega$		130		kHz
SR	Slew Rate	$A_V = +1$	Falling Edge	33 32	58	V/ms
			Rising Edge	33 32	48	
θ_m	Phase Margin	$C_L = 20\text{ pF}, R_L = 10\text{ k}\Omega$		78		deg
G_m	Gain Margin	$C_L = 20\text{ pF}, R_L = 10\text{ k}\Omega$		27		dB

Symbol	Parameter	Conditions	Min (Note 6)	Typ (Note 5)	Max (Note 6)	Units
e_n	Input-Referred Voltage Noise Density	$f = 1 \text{ kHz}$		60		$\text{nV}/\sqrt{\text{Hz}}$
	Input-Referred Voltage Noise	0.1 Hz to 10 Hz		2.3		μV_{PP}
i_n	Input-Referred Current Noise	$f = 1 \text{ kHz}$		10		$\text{fA}/\sqrt{\text{Hz}}$
THD+N	Total Harmonic Distortion + Noise	$f = 100 \text{ Hz}, R_L = 10 \text{ k}\Omega$		0.002		%

3.3V DC Electrical Characteristics

(Note 4) Unless otherwise specified, all limits guaranteed for $T_A = 25^\circ\text{C}$, $V^+ = 3.3\text{V}$, $V^- = 0\text{V}$, $V_{\text{CM}} = V_O = V^+/2$, and $R_L > 1 \text{ M}\Omega$. **Boldface** limits apply at the temperature extremes.

Symbol	Parameter	Conditions	Min (Note 6)	Typ (Note 5)	Max (Note 6)	Units
V_{OS}	Input Offset Voltage			± 10	± 160 ± 250	μV
TCV_{OS}	Input Offset Voltage Drift	LMP2231A		± 0.3	± 0.4	$\mu\text{V}/^\circ\text{C}$
		LMP2231B		± 0.3	± 2.5	
I_{BIAS}	Input Bias Current			0.02	± 1 ± 50	pA
I_{OS}	Input Offset Current			5		fA
CMRR	Common Mode Rejection Ratio	$0\text{V} \leq V_{\text{CM}} \leq 2.3\text{V}$	79 77	92		dB
PSRR	Power Supply Rejection Ratio	$1.6\text{V} \leq V^+ \leq 5.5\text{V}$ $V^- = 0\text{V}, V_{\text{CM}} = 0\text{V}$	83 83	120		dB
CMVR	Common Mode Voltage Range	CMRR $\geq 78 \text{ dB}$ CMRR $\geq 77 \text{ dB}$	-0.2 -0.2		2.5 2.5	V
A_{VOL}	Large Signal Voltage Gain	$V_O = 0.3\text{V}$ to 3V $R_L = 10 \text{ k}\Omega$ to $V^+/2$	108 107	120		dB
V_O	Output Swing High	$R_L = 10 \text{ k}\Omega$ to $V^+/2$ $V_{\text{IN}}(\text{diff}) = 100 \text{ mV}$		14	50 50	mV from either rail
	Output Swing Low	$R_L = 10 \text{ k}\Omega$ to $V^+/2$ $V_{\text{IN}}(\text{diff}) = -100 \text{ mV}$		14	50 50	
I_O	Output Current (Note 7)	Sourcing, V_O to V^- $V_{\text{IN}}(\text{diff}) = 100 \text{ mV}$	11 8	14		mA
		Sinking, V_O to V^+ $V_{\text{IN}}(\text{diff}) = -100 \text{ mV}$	8 5	11		
I_S	Supply Current			10	15 16	μA

3.3V AC Electrical Characteristics

(Note 4) Unless otherwise is specified, all limits guaranteed for $T_A = 25^\circ\text{C}$, $V^+ = 3.3\text{V}$, $V^- = 0\text{V}$, $V_{\text{CM}} = V_O = V^+/2$, and $R_L > 1 \text{ M}\Omega$. **Boldface** limits apply at the temperature extremes.

Symbol	Parameter	Conditions	Min (Note 6)	Typ (Note 5)	Max (Note 6)	Units
GBW	Gain-Bandwidth Product	$C_L = 20 \text{ pF}, R_L = 10 \text{ k}\Omega$		128		kHz
SR	Slew Rate	$A_V = +1, C_L = 20 \text{ pF}$ $R_L = 10 \text{ k}\Omega$	Falling Edge		58	V/ms
			Rising Edge		48	
θ_m	Phase Margin	$C_L = 20 \text{ pF}, R_L = 10 \text{ k}\Omega$		76		deg
G_m	Gain Margin	$C_L = 20 \text{ pF}, R_L = 10 \text{ k}\Omega$		26		dB
e_n	Input-Referred Voltage Noise Density	$f = 1 \text{ kHz}$		60		$\text{nV}/\sqrt{\text{Hz}}$
	Input-Referred Voltage Noise	0.1 Hz to 10 Hz		2.4		μV_{PP}
i_n	Input-Referred Current Noise	$f = 1 \text{ kHz}$		10		$\text{fA}/\sqrt{\text{Hz}}$
THD+N	Total Harmonic Distortion + Noise	$f = 100 \text{ Hz}, R_L = 10 \text{ k}\Omega$		0.003		%

2.5V DC Electrical Characteristics (Note 4)

Unless otherwise specified, all limits guaranteed for $T_A = 25^\circ\text{C}$, $V^+ = 2.5\text{V}$, $V^- = 0\text{V}$, $V_{\text{CM}} = V_O = V^+/2$, and $R_L > 1\text{M}\Omega$. **Boldface** limits apply at the temperature extremes.

Symbol	Parameter	Conditions	Min (Note 6)	Typ (Note 5)	Max (Note 6)	Units
V_{OS}	Input Offset Voltage			± 10	± 190 ± 275	μV
TCV_{OS}	Input Offset Voltage Drift	LMP2231A		± 0.3	± 0.4	$\mu\text{V}/^\circ\text{C}$
		LMP2231B		± 0.3	± 2.5	
I_{BIAS}	Input Bias Current			0.02	± 1.0 ± 50	pA
I_{OS}	Input Offset Current			5		fA
CMRR	Common Mode Rejection Ratio	$0\text{V} \leq V_{\text{CM}} \leq 1.5\text{V}$	77 76	91		dB
PSRR	Power Supply Rejection Ratio	$1.6\text{V} \leq V^+ \leq 5.5\text{V}$ $V^- = 0\text{V}$, $V_{\text{CM}} = 0\text{V}$	83 83	120		dB
CMVR	Common Mode Voltage Range	CMRR ≥ 77 dB CMRR ≥ 76 dB	-0.2 -0.2		1.7 1.7	V
A_{VOL}	Large Signal Voltage Gain	$V_O = 0.3\text{V}$ to 2.2V $R_L = 10\text{ k}\Omega$ to $V^+/2$	104 104	120		dB
V_O	Output Swing High	$R_L = 10\text{ k}\Omega$ to $V^+/2$ $V_{\text{IN}}(\text{diff}) = 100\text{ mV}$		12	50 50	mV from either rail
	Output Swing Low	$R_L = 10\text{ k}\Omega$ to $V^+/2$ $V_{\text{IN}}(\text{diff}) = -100\text{ mV}$		13	50 50	
I_O	Output Current (Note 7)	Sourcing, V_O to V^- $V_{\text{IN}}(\text{diff}) = 100\text{ mV}$	5 4	8		mA
		Sinking, V_O to V^+ $V_{\text{IN}}(\text{diff}) = -100\text{ mV}$	3.5 2.5	7		
I_S	Supply Current			10	14 15	μA

2.5V AC Electrical Characteristics (Note 4)

Unless otherwise specified, all limits guaranteed for $T_A = 25^\circ\text{C}$, $V^+ = 2.5\text{V}$, $V^- = 0\text{V}$, $V_{\text{CM}} = V_O = V^+/2$, and $R_L > 1\text{M}\Omega$. **Boldface** limits apply at the temperature extremes.

Symbol	Parameter	Conditions	Min (Note 6)	Typ (Note 5)	Max (Note 6)	Units
GBW	Gain-Bandwidth Product	$C_L = 20\text{ pF}$, $R_L = 10\text{ k}\Omega$		128		kHz
SR	Slew Rate	$A_V = +1$, $C_L = 20\text{ pF}$ $R_L = 10\text{ k}\Omega$	Falling Edge		58	V/ms
			Rising Edge		48	
θ_m	Phase Margin	$C_L = 20\text{ pF}$, $R_L = 10\text{ k}\Omega$		74		deg
G_m	Gain Margin	$C_L = 20\text{ pF}$, $R_L = 10\text{ k}\Omega$		26		dB
e_n	Input-Referred Voltage Noise Density	$f = 1\text{ kHz}$		60		$\text{nV}/\sqrt{\text{Hz}}$
	Input-Referred Voltage Noise	0.1 Hz to 10 Hz		2.5		μV_{PP}
i_n	Input-Referred Current Noise	$f = 1\text{ kHz}$		10		$\text{fA}/\sqrt{\text{Hz}}$
THD+N	Total Harmonic Distortion + Noise	$f = 100\text{ Hz}$, $R_L = 10\text{ k}\Omega$		0.005		%

1.8V DC Electrical Characteristics (Note 4)

Unless otherwise specified, all limits guaranteed for $T_A = 25^\circ\text{C}$, $V^+ = 1.8\text{V}$, $V^- = 0\text{V}$, $V_{\text{CM}} = V_O = V^+/2$, and $R_L > 1\text{M}\Omega$. **Boldface** limits apply at the temperature extremes.

Symbol	Parameter	Conditions	Min (Note 6)	Typ (Note 5)	Max (Note 6)	Units
V_{OS}	Input Offset Voltage			± 10	± 230 ± 325	μV
TCV_{OS}	Input Offset Voltage Drift	LMP2231A		± 0.3	± 0.4	$\mu\text{V}/^\circ\text{C}$
		LMP2231B		± 0.3	± 2.5	
I_{BIAS}	Input Bias Current			0.02	± 1.0 ± 50	pA
I_{OS}	Input Offset Current			5		fA
CMRR	Common Mode Rejection Ratio	$0\text{V} \leq V_{\text{CM}} \leq 0.8\text{V}$	76 75	92		dB
PSRR	Power Supply Rejection Ratio	$1.6\text{V} \leq V^+ \leq 5.5\text{V}$ $V^- = 0\text{V}$, $V_{\text{CM}} = 0\text{V}$	83 83	120		dB
CMVR	Common Mode Voltage Rang	CMRR $\geq 76\text{ dB}$ CMRR $\geq 75\text{ dB}$	-0.2 0		1.0 1.0	V
A_{VOL}	Large Signal Voltage Gain	$V_O = 0.3\text{V}$ to 1.5V $R_L = 10\text{ k}\Omega$ to $V^+/2$	103 103	120		dB
V_O	Output Swing High	$R_L = 10\text{ k}\Omega$ to $V^+/2$ $V_{\text{IN}}(\text{diff}) = 100\text{ mV}$		12	50 50	mV from either rail
	Output Swing Low	$R_L = 10\text{ k}\Omega$ to $V^+/2$ $V_{\text{IN}}(\text{diff}) = -100\text{ mV}$		13	50 50	
I_O	Output Current (Note 7)	Sourcing, V_O to V^- $V_{\text{IN}}(\text{diff}) = 100\text{ mV}$	2.5 2	5		mA
		Sinking, V_O to V^+ $V_{\text{IN}}(\text{diff}) = -100\text{ mV}$	2 1.5	5		
I_S	Supply Current			10	14 15	μA

1.8V AC Electrical Characteristics (Note 4)

Unless otherwise is specified, all limits guaranteed for $T_A = 25^\circ\text{C}$, $V^+ = 1.8\text{V}$, $V^- = 0\text{V}$, $V_{\text{CM}} = V_O = V^+/2$, and $R_L > 1\text{M}\Omega$. **Boldface** limits apply at the temperature extremes.

Symbol	Parameter	Conditions	Min (Note 6)	Typ (Note 5)	Max (Note 6)	Units
GBW	Gain-Bandwidth Product	$C_L = 20\text{ pF}$, $R_L = 10\text{ k}\Omega$		127		kHz
SR	Slew Rate	$A_V = +1$, $C_L = 20\text{ pF}$ $R_L = 10\text{ k}\Omega$	Falling Edge		58	V/ms
		Rising Edge		48		
θ_m	Phase Margin	$C_L = 20\text{ pF}$, $R_L = 10\text{ k}\Omega$		70		deg
G_m	Gain Margin	$C_L = 20\text{ pF}$, $R_L = 10\text{ k}\Omega$		25		dB
e_n	Input-Referred Voltage Noise Density	$f = 1\text{ kHz}$		60		$\text{nV}/\sqrt{\text{Hz}}$
	Input-Referred Voltage Noise	0.1 Hz to 10 Hz		2.4		μV_{PP}
i_n	Input-Referred Current Noise	$f = 1\text{ kHz}$		10		$\text{fA}/\sqrt{\text{Hz}}$
THD+N	Total Harmonic Distortion + Noise	$f = 100\text{ Hz}$, $R_L = 10\text{ k}\Omega$		0.005		$\%$

Note 1: Absolute Maximum Ratings indicate limits beyond which damage may occur. Operating Ratings indicate conditions for which the device is intended to be functional, but specific performance is not guaranteed. For guaranteed specifications and test conditions, see the Electrical Characteristics.

Note 2: Human Body Model, applicable std. MIL-STD-883, Method 3015.7. Machine Model, applicable std. JESD22-A115-A (ESD MM std. of JEDEC) Field-Induced Charge-Device Model, applicable std. JESD22-C101-C (ESD FICDM std. of JEDEC).

Note 3: The maximum power dissipation is a function of $T_{J(MAX)}$, θ_{JA} . The maximum allowable power dissipation at any ambient temperature is $P_D = (T_{J(MAX)} - T_A) / \theta_{JA}$. All numbers apply for packages soldered directly onto a PC Board.

Note 4: Electrical Table values apply only for factory testing conditions at the temperature indicated. Factory testing conditions result in very limited self-heating of the device such that $T_J = T_A$. No guarantee of parametric performance is indicated in the electrical tables under conditions of internal self-heating where $T_J > T_A$. Absolute Maximum Ratings indicate junction temperature limits beyond which the device may be permanently degraded, either mechanically or electrically.

Note 5: Typical values represent the most likely parametric norm at the time of characterization. Actual typical values may vary over time and will also depend on the application and configuration. The typical values are not tested and are not guaranteed on shipped production material.

Note 6: All limits are guaranteed by testing, statistical analysis or design.

Note 7: The short circuit test is a momentary open loop test.

Connection Diagrams

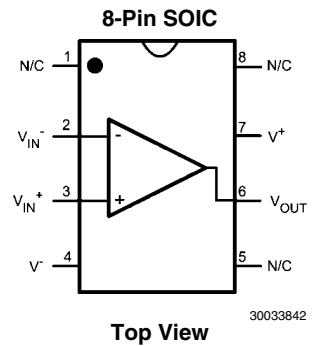
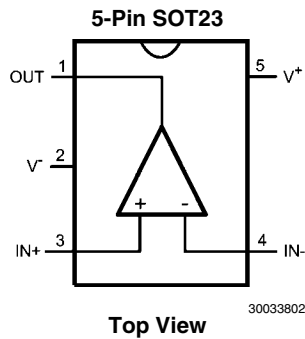

Ordering Information

Package	Part Number	Temperature Range	Package Marking	Transport Media	NSC Drawing	
5-Pin SOT23	LMP2231AMF	-40°C to 125°C	AL5A	1k Units Tape and Reel	MF05A	
	LMP2231AMFE			250 Units Tape and Reel		
	LMP2231AMFX			3k Units Tape and Reel		
	LMP2231BMF		AL5B	1k Units Tape and Reel		
	LMP2231BMFE			250 Units Tape and Reel		
	LMP2231BMFX			3k Units Tape and Reel		
8-Pin SOIC	LMP2231AMA		LMP2231AMA	95 Units/Rail	M08A	
	LMP2231AMAE			250 Units Tape and Reel		
	LMP2231AMAX			2.5k Units Tape and Reel		
	LMP2231BMA			LMP2231BMA		95 Units/Rail
	LMP2231BMAE					250 Units Tape and Reel
	LMP2231BMAX					2.5k Units Tape and Reel

Typical Performance Characteristics

Unless otherwise Specified: $T_A = 25^\circ\text{C}$, $V_S = 5\text{V}$, $V_{CM} = V_S/2$, where

$$V_S = V^+ - V^-$$

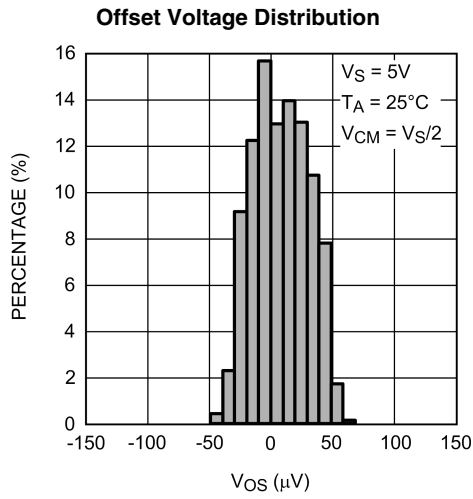

30033807

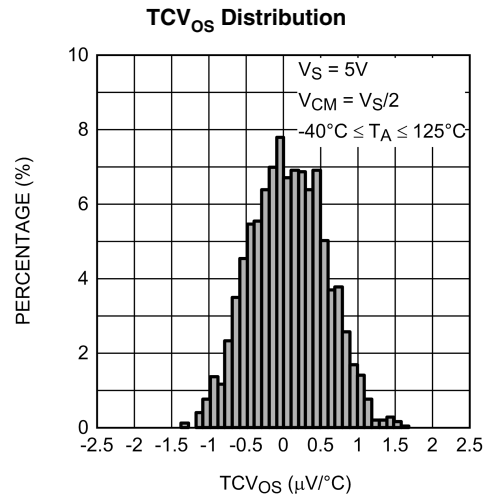

30033811

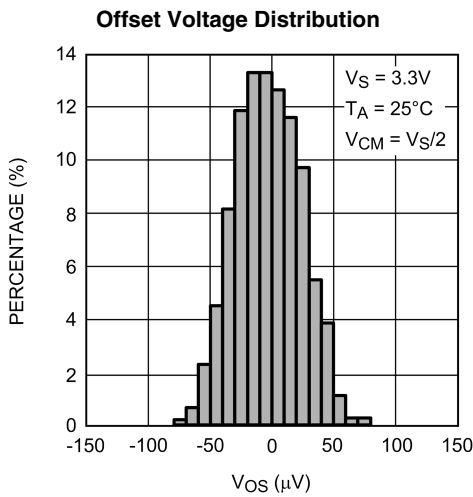

30033806

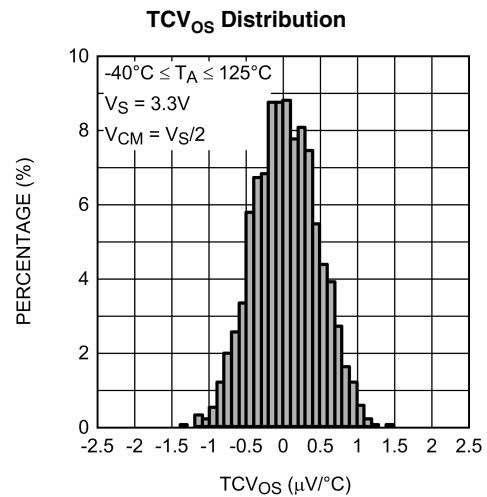

30033810

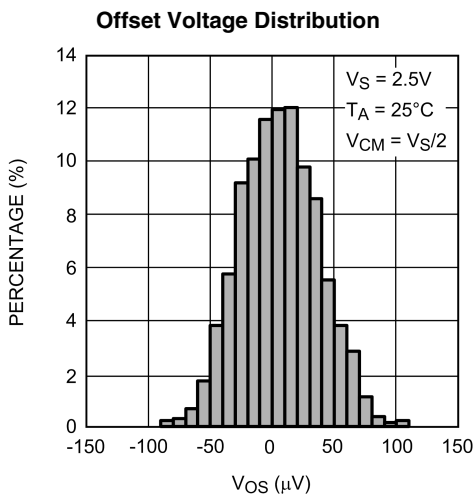

30033805

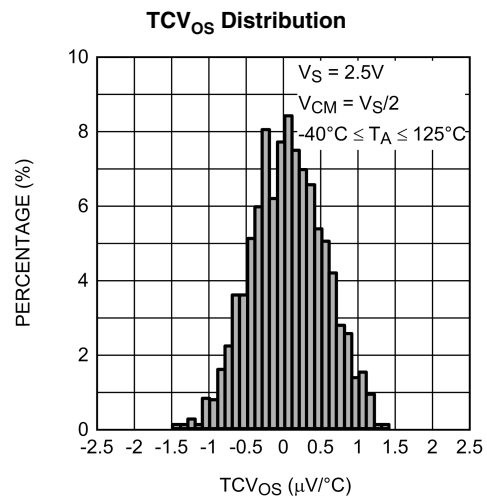

30033809

Offset Voltage Distribution

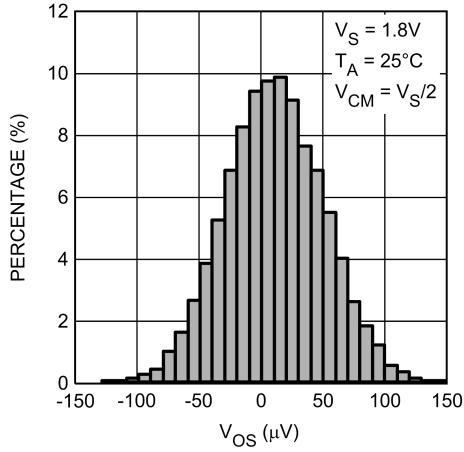

30033873

TCV_{OS} Distribution

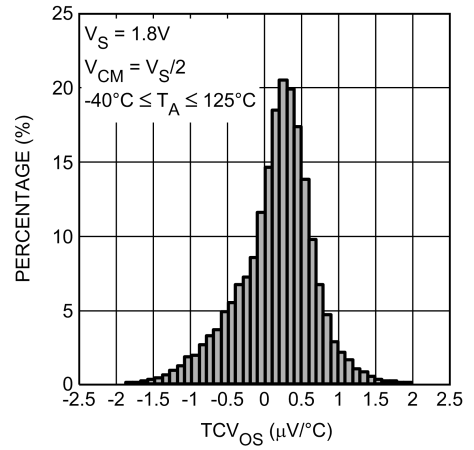

30033869

Offset Voltage vs. V_{CM}

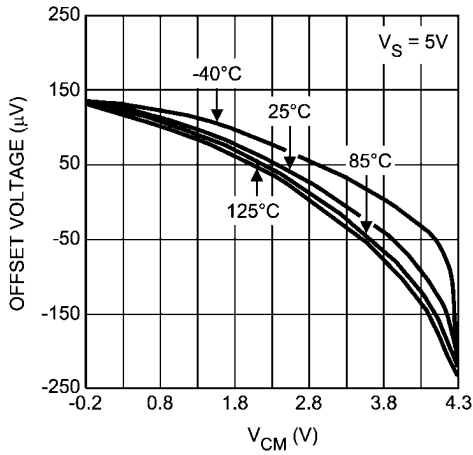

30033818

Offset Voltage vs. V_{CM}

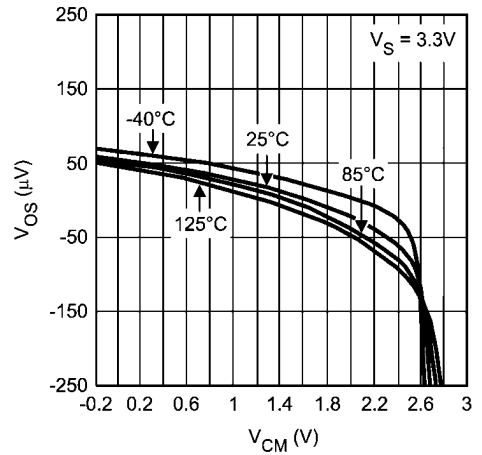

30033865

Offset Voltage vs. V_{CM}

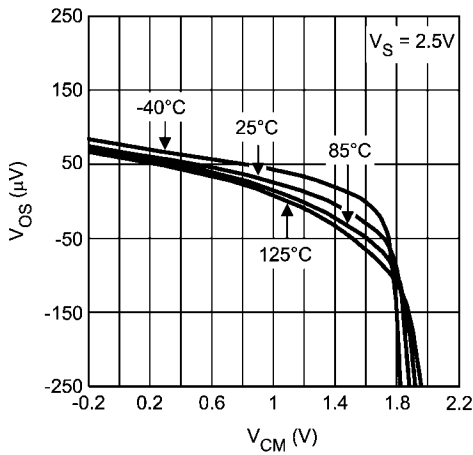

30033864

Offset Voltage vs. V_{CM}

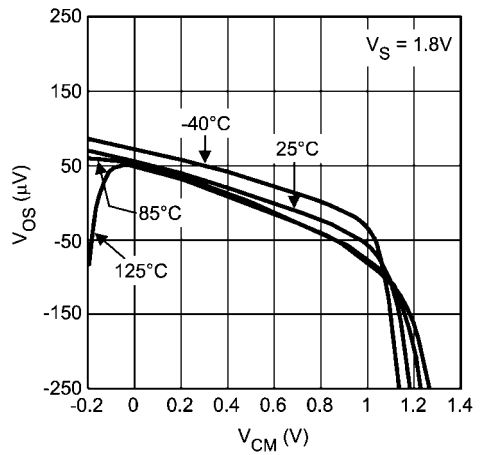

30033872

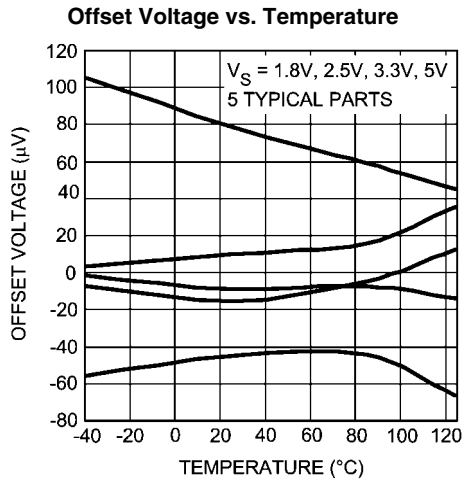

30033871

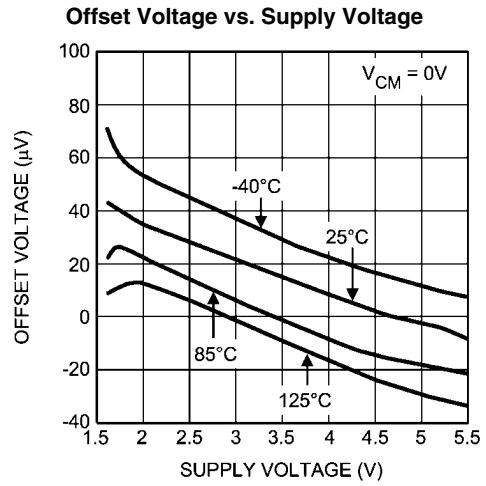

30033870

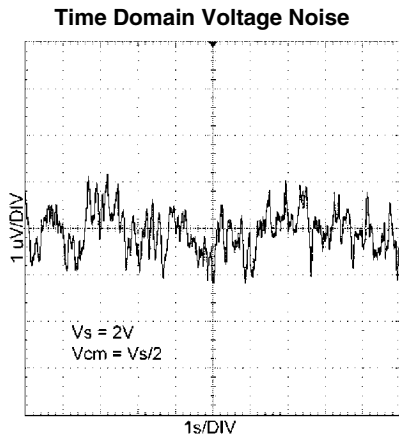

30033833

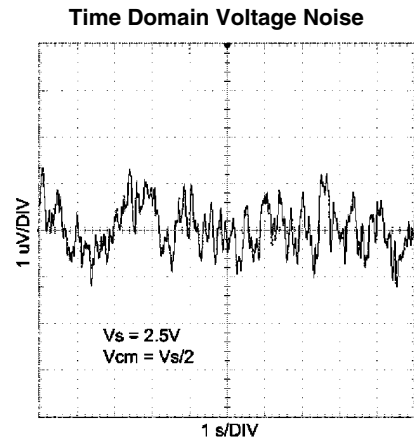

30033834

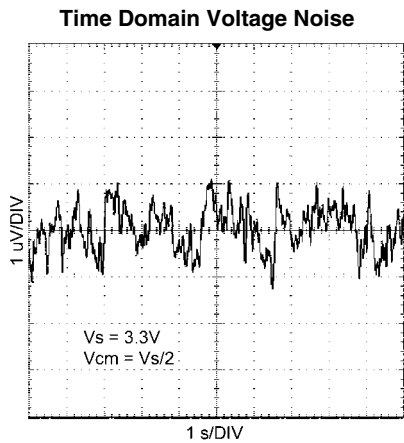

30033832

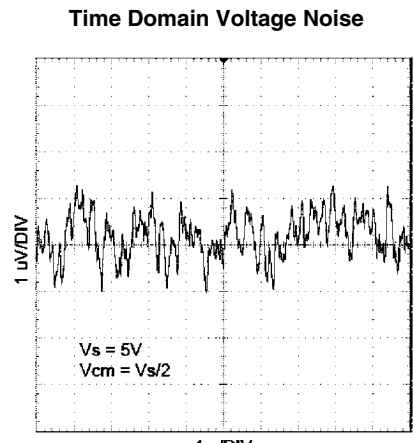

30033831

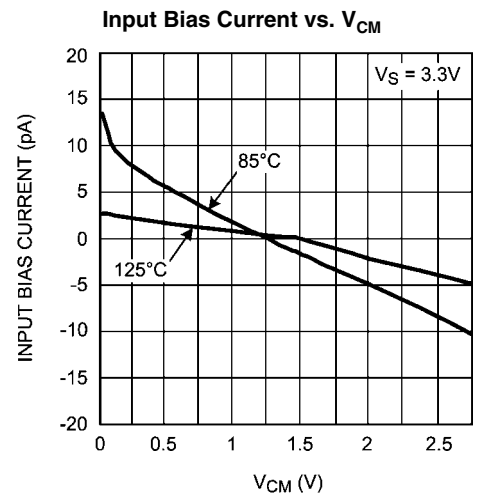
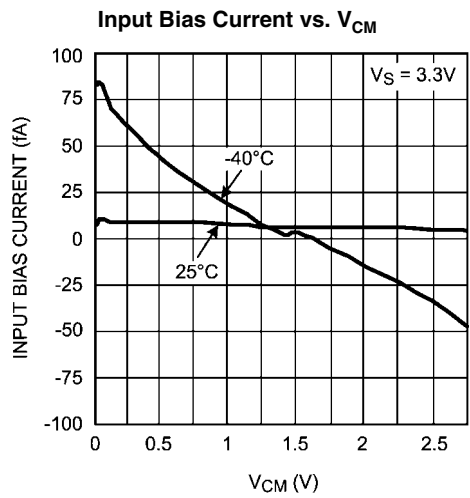
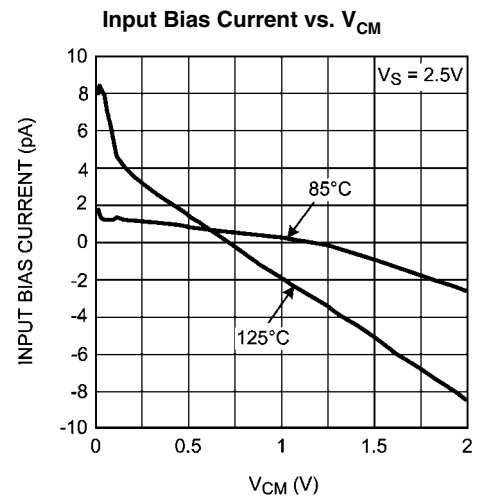
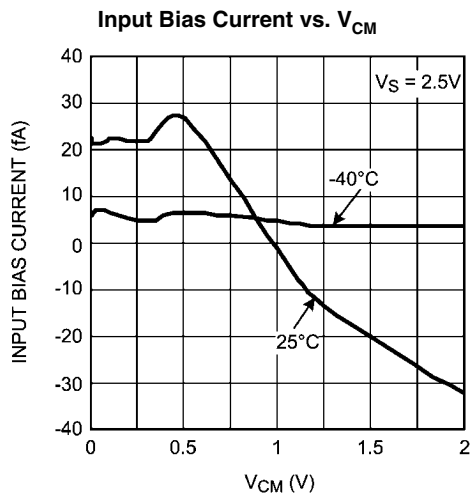
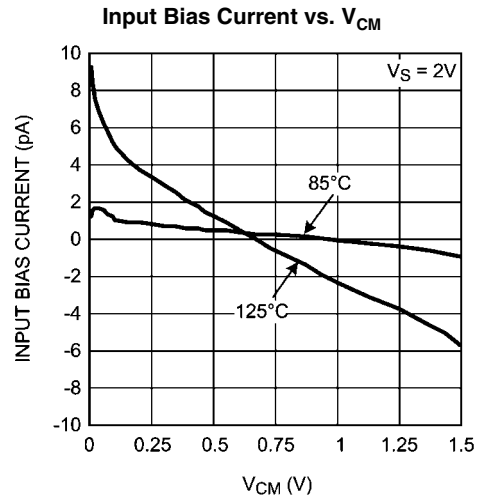
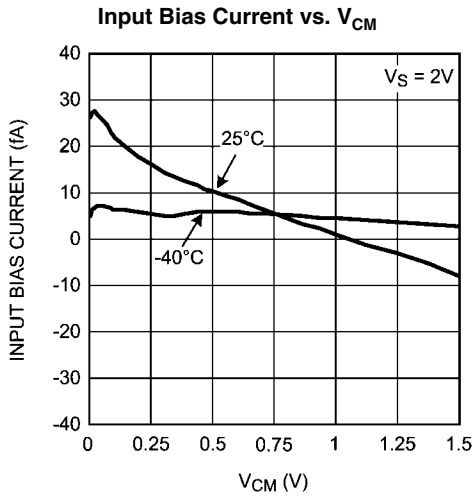

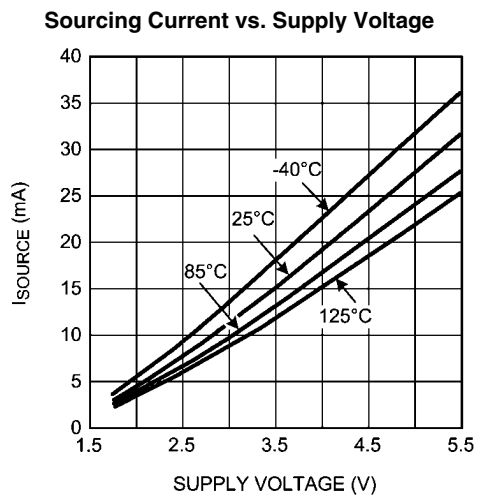
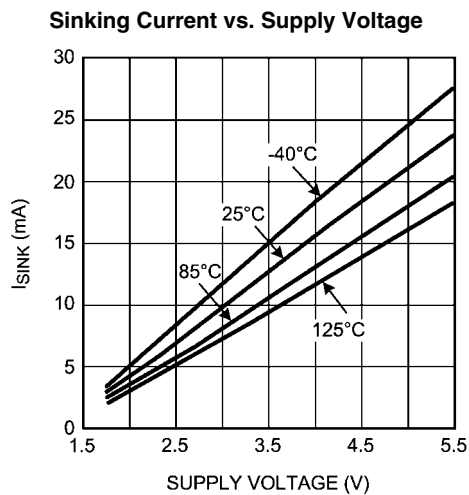
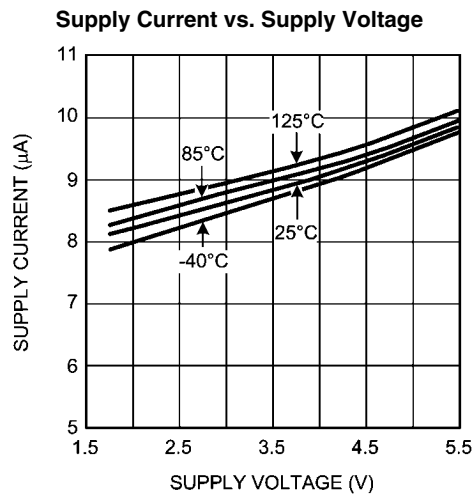
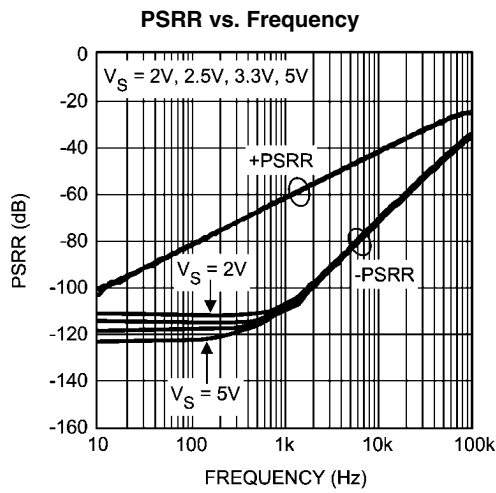
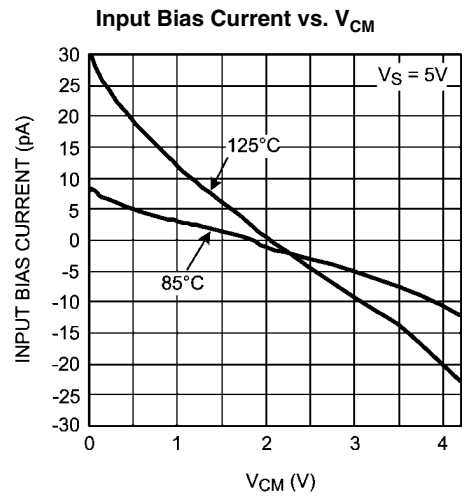
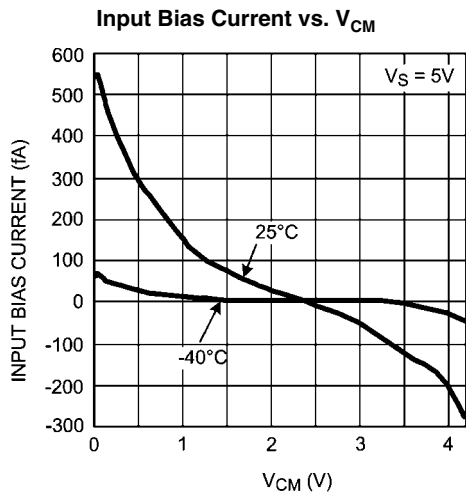

Output Swing High vs. Supply Voltage

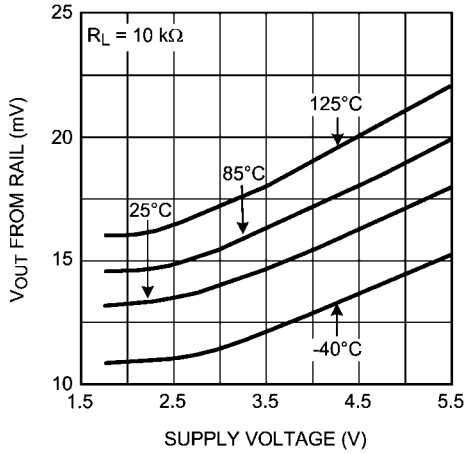

30033815

Output Swing Low vs. Supply Voltage

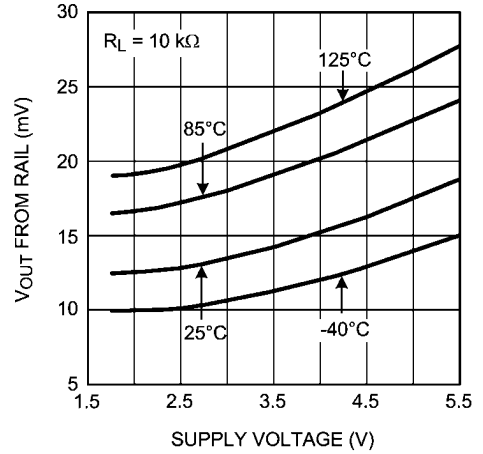

30033816

Open Loop Frequency Response

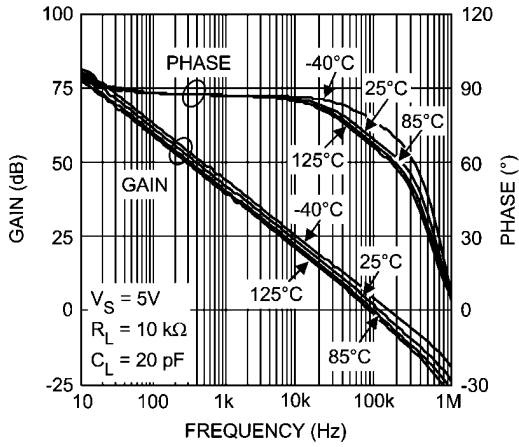

30033821

Open Loop Frequency Response

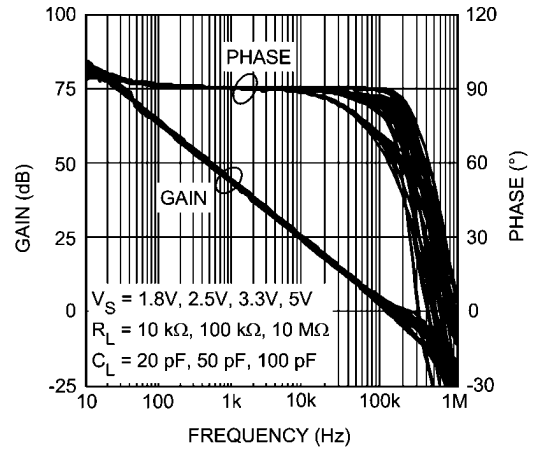

30033822

Phase Margin vs. Capacitive Load

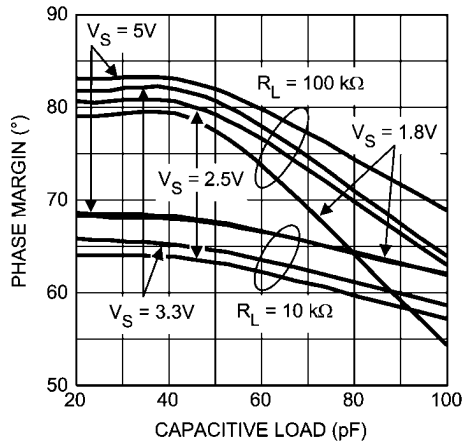

30033863

Slew Rate vs. Supply Voltage

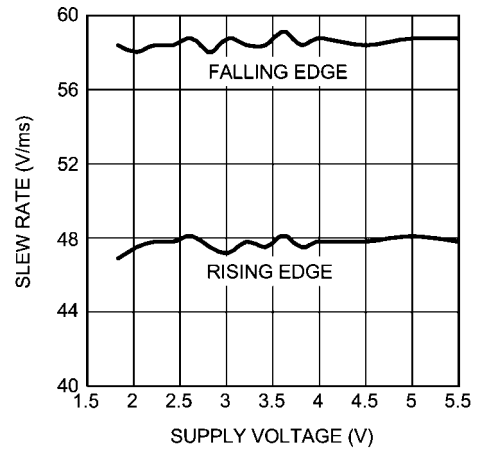

30033830

THD+N vs. Amplitude

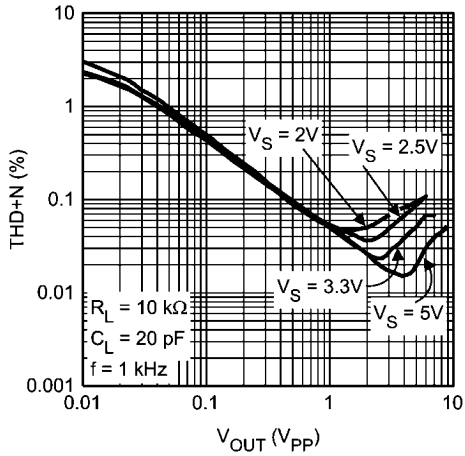

30033828

THD+N vs. Frequency

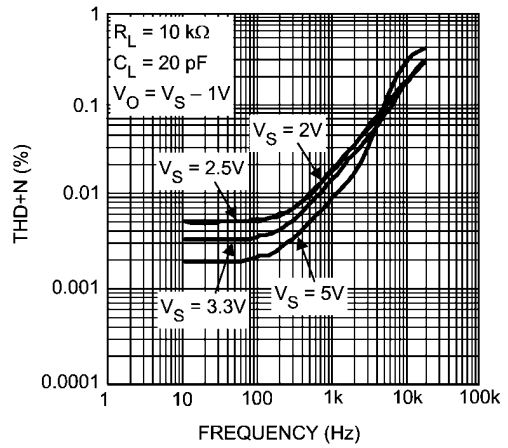

30033829

Large Signal Step Response

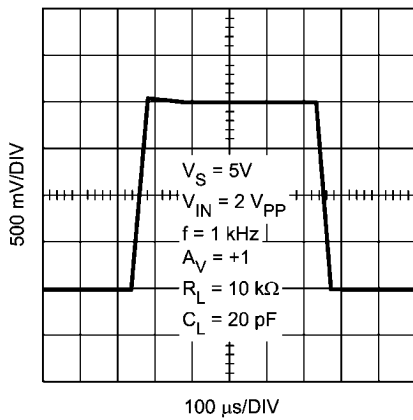

30033824

Small Signal Step Response

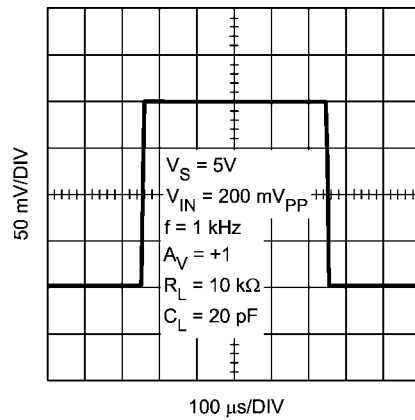

30033823

Large Signal Step Response

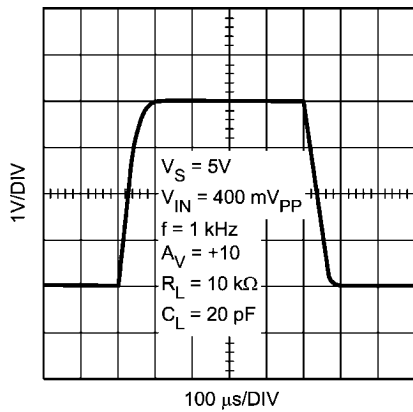

30033826

Small Signal Step Response

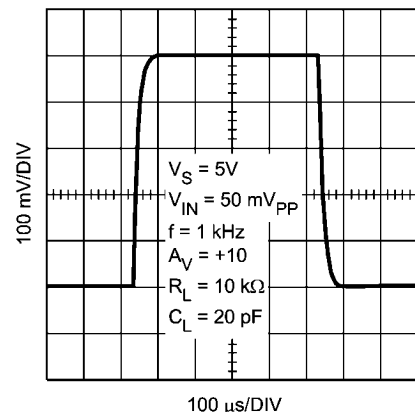

30033825

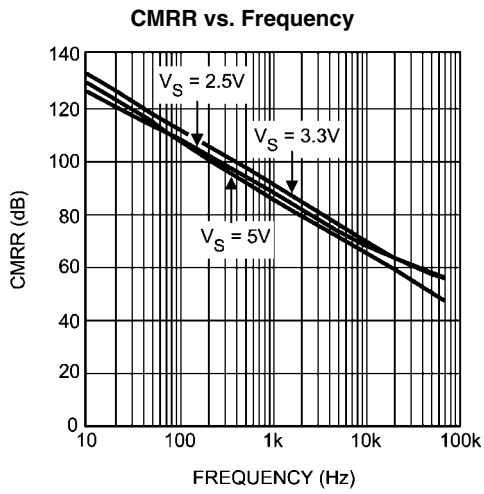

30033867

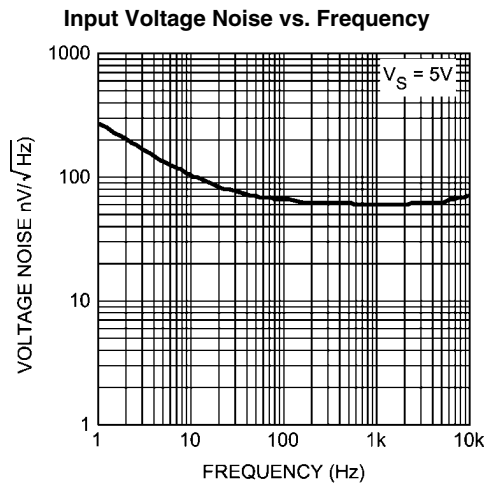

30033819

Application Information

LMP2231

The LMP2231 is a single CMOS precision amplifier that offer low offset voltage and low offset voltage drift, and high gain while only consuming 10 μ A of current per channel.

The LMP2231 is a micropower op amp, consuming only 10 μ A of current. Micropower op amps extend the run time of battery powered systems and reduce energy consumption in energy limited systems. The guaranteed supply voltage range of 1.8V to 5.0V along with the ultra-low supply current extend the battery run time in two ways. The extended guaranteed power supply voltage range of 1.8V to 5.0V enables the op amp to function when the battery voltage has depleted from its nominal value down to 1.8V. In addition, the lower power consumption increases the life of the battery.

The LMP2231 has an input referred offset voltage of only $\pm 150 \mu$ V maximum at room temperature. This offset is guaranteed to be less than $\pm 230 \mu$ V over temperature. This minimal offset voltage along with very low TCV_{OS} of only 0.3 μ V/ $^{\circ}$ C typical allows more accurate signal detection and amplification in precision applications.

The low input bias current of only ± 20 fA gives the LMP2231 superiority for use in high impedance sensor applications. Bias Current of an amplifier flows through source resistance of the sensor and the voltage resulting from this current flow appears as a noise voltage on the input of the amplifier. The low input bias current enables the LMP2231 to interface with high impedance sensors while generating negligible voltage noise. Thus the LMP2231 provides better signal fidelity and a higher signal-to-noise ration when interfacing with high impedance sensors.

National Semiconductor is heavily committed to precision amplifiers and the market segment they serve. Technical support and extensive characterization data is available for sensitive applications or applications with a constrained error budget.

The operating supply voltage range of 1.8V to 5.5V over the extensive temperature range of -40° C to 125° C makes the LMP2231 an excellent choice for low voltage precision applications with extensive temperature requirements.

The LMP2231 is offered in the space saving 5-Pin SOT23 and 8-pin SOIC package. These small packages are ideal solutions for area constrained PC boards and portable electronics.

TOTAL NOISE CONTRIBUTION

The LMP2231 has a very low input bias current, very low input current noise, and low input voltage noise for micropower amplifier. As a result, this amplifier makes a great choice for circuits with high impedance sensor applications.

Figure 1 shows the typical input noise of the LMP2231 as a function of source resistance where:

e_n denotes the input referred voltage noise

e_i is the voltage drop across source resistance due to input referred current noise or $e_i = R_S * i_n$

e_t shows the thermal noise of the source resistance

e_{ni} shows the total noise on the input.

Where:

$$e_{ni} = \sqrt{e_n^2 + e_i^2 + e_t^2}$$

The input current noise of the LMP2231 is so low that it will not become the dominant factor in the total noise unless source resistance exceeds 300 M Ω , which is an unrealistically high value. As is evident in Figure 1, at lower R_S values, total noise is dominated by the amplifier's input voltage noise. Once R_S is larger than a 100 k Ω , then the dominant noise factor becomes the thermal noise of R_S . As mentioned before, the current noise will not be the dominant noise factor for any practical application.

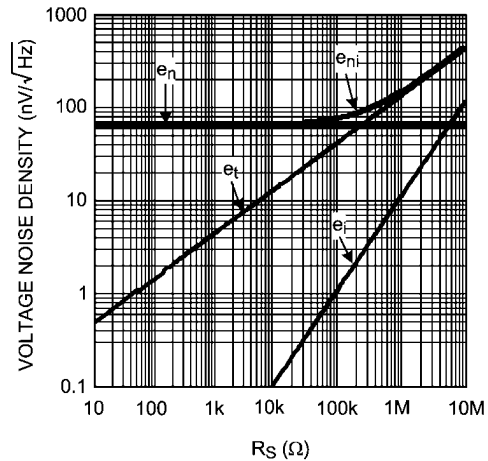

30033848

FIGURE 1. Total Input Noise

VOLTAGE NOISE REDUCTION

The LMP2231 has an input voltage noise of 60 nV/ $\sqrt{\text{Hz}}$. While this value is very low for micropower amplifiers, this input voltage noise can be further reduced by placing N amplifiers in parallel as shown in Figure 2. The total voltage noise on the output of this circuit is divided by the square root of the number of amplifiers used in this parallel combination. This is because each individual amplifier acts as an independent noise source, and the average noise of independent sources is the quadrature sum of the independent sources divided by the number of sources. For N identical amplifiers, this means:

$$\begin{aligned} \text{REDUCED INPUT VOLTAGE NOISE} &= \frac{1}{N} \sqrt{e_{n1}^2 + e_{n2}^2 + \dots + e_{nN}^2} \\ &= \frac{1}{N} \sqrt{N e_n^2} = \frac{\sqrt{N}}{N} e_n \\ &= \frac{1}{\sqrt{N}} e_n \end{aligned}$$

Figure 2 shows a schematic of this input voltage noise reduction circuit. Typical resistor values are: $R_G = 10\Omega$, $R_F = 1\text{ k}\Omega$, and $R_O = 1\text{ k}\Omega$.

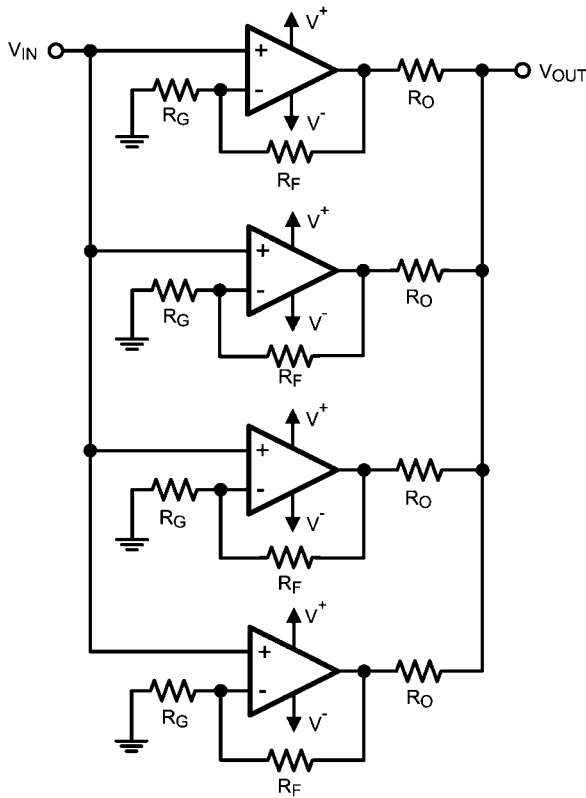

30033846

FIGURE 2. Noise Reduction Circuit

PRECISION INSTRUMENTATION AMPLIFIER

Measurement of very small signals with an amplifier requires close attention to the input impedance of the amplifier, gain of the overall signal on the inputs, and the gain on each input of the amplifier. This is because the difference of the input signal on the two inputs is of the interest and the common signal is considered noise. A classic circuit implementation is an instrumentation amplifier. Instrumentation amplifiers have a finite, accurate, and stable gain. They also have extremely high input impedances and very low output impedances. Finally they have an extremely high CMRR so that the amplifier can only respond to the differential signal. A typical instrumentation amplifier is shown in Figure 3.

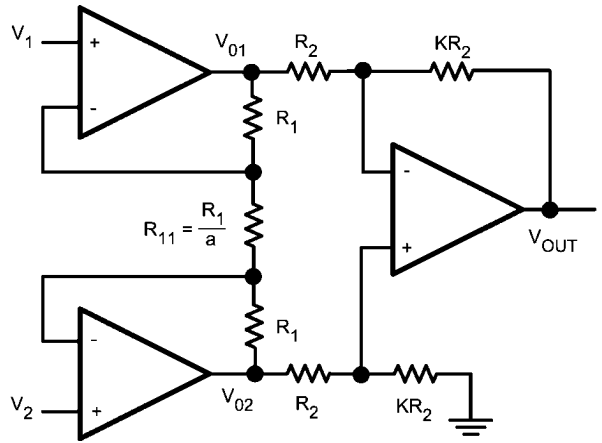

30033836

FIGURE 3. Instrumentation Amplifier

There are two stages in this amplifier. The last stage, output stage, is a differential amplifier. In an ideal case the two amplifiers of the first stage, input stage, would be set up as buffers to isolate the inputs. However they cannot be connected as followers because of mismatch of amplifiers. That is why there is a balancing resistor between the two. The product of the two stages of gain will give the gain of the instrumentation amplifier. Ideally, the CMRR should be infinite. However the output stage has a small non-zero common mode gain which results from resistor mismatch.

In the input stage of the circuit, current is the same across all resistors. This is due to the high input impedance and low input bias current of the LMP2231.

$$\text{GIVEN: } I_{R_1} = I_{R_{11}} \tag{1}$$

By Ohm's Law:

$$\begin{aligned} V_{O1} - V_{O2} &= (2R_1 + R_{11}) I_{R_{11}} \\ &= (2a + 1) R_{11} \cdot I_{R_{11}} \\ &= (2a + 1) V_{R_{11}} \end{aligned} \tag{2}$$

However:

$$V_{R_{11}} = V_1 - V_2 \tag{3}$$

So we have:

$$V_{O1} - V_{O2} = (2a+1)(V_1 - V_2) \tag{4}$$

Now looking at the output of the instrumentation amplifier:

$$\begin{aligned} V_O &= \frac{KR_2}{R_2} (V_{O2} - V_{O1}) \\ &= -K (V_{O1} - V_{O2}) \end{aligned} \tag{5}$$

Substituting from Equation 4:

$$V_O = -K (2a + 1) (V_1 - V_2) \tag{6}$$

This shows the gain of the instrumentation amplifier to be:

$$-K(2a+1)$$

Typical values for this circuit can be obtained by setting: $a = 12$ and $K = 4$. This results in an overall gain of -100 .

SINGLE SUPPLY STRAIN GAGE BRIDGE AMPLIFIER

Strain gauges are popular electrical elements used to measure force or pressure. Strain gauges are subjected to an unknown force which is measured as a the deflection on a previously calibrated scale. Pressure is often measured using the same technique; however this pressure needs to be converted into force using an appropriate transducer. Strain gauges are often resistors which are sensitive to pressure or to flexing. Sense resistor values range from tens of ohms to several hundred kilo ohms. The resistance change which is a result of applied force across the strain gauge might be 1% of its total value. An accurate and reliable system is needed to measure this small resistance change. Bridge configurations offer a reliable method for this measurement.

Bridge sensors are formed of four resistors, connected as a quadrilateral. A voltage source or a current source is used across one of the diagonals to excite the bridge while a voltage detector across the other diagonal measures the output voltage.

Bridges are mainly used as null circuits or to measure a differential voltages. Bridges will have no output voltage if the

ratios of two adjacent resistor values are equal. This fact is used in null circuit measurements. These are particularly used in feedback systems which involve electrochemical elements or human interfaces. Null systems force an active resistor, such as a strain gauge, to balance the bridge by influencing the measured parameter.

Often in sensor applications at least one of the resistors is a variable resistor, or a sensor. The deviation of this active element from its initial value is measured as an indication of change in the measured quantity. A change in output voltage represents the sensor value change. Since the sensor value change is often very small, the resulting output voltage is very small in magnitude as well. This requires an extensive and very precise amplification circuitry so that signal fidelity does not change after amplification.

Sensitivity of a bridge is the ratio of its maximum expected output change to the excitation voltage change.

Figure 4 (a) shows a typical bridge sensor and Figure 4(b) shows the bridge with four sensors. R in Figure 4(b) is the nominal value of the sense resistor and the deviations from R are proportional to the quantity being measured.

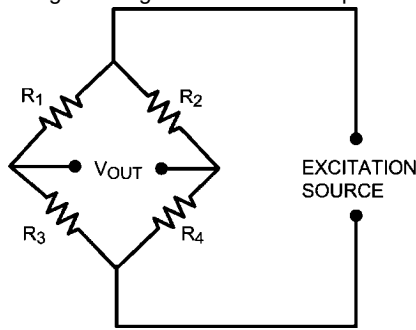

(a)

$$V_{OUT} = \frac{\frac{R_3}{R_1} - \frac{R_4}{R_2}}{\left(1 + \frac{R_3}{R_1}\right)\left(1 + \frac{R_4}{R_2}\right)} \times V_{SOURCE}$$

30033850

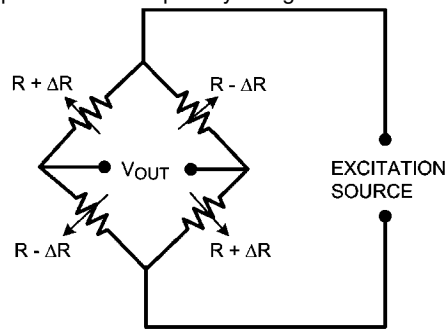

(b)

$$V_{OUT} = \frac{\Delta R}{R} \times V_{SOURCE}$$

30033851

FIGURE 4. Bridge Sensor

Instrumentation amplifiers are great for interfacing with bridge sensors. Bridge sensors often sense a very small differential signal in the presence of a larger common mode voltage. Instrumentation amplifiers reject this common mode signal.

Figure 5 shows a strain gauge bridge amplifier. In this application the LMP2231 is used to buffer the LM4140's precision output voltage. The LM4140A is a precision voltage refer-

ence. The other three LMP2231s are used to form an instrumentation amplifier. This instrumentation amplifier uses the LMP2231's high CMRR and low V_{OS} and TCV_{OS} to accurately amplify the small differential signal generated by the output of the bridge sensor. This amplified signal is then fed into the ADC121S021 which is a 12-bit analog to digital converter. This circuit works on a single supply voltage of 5V.

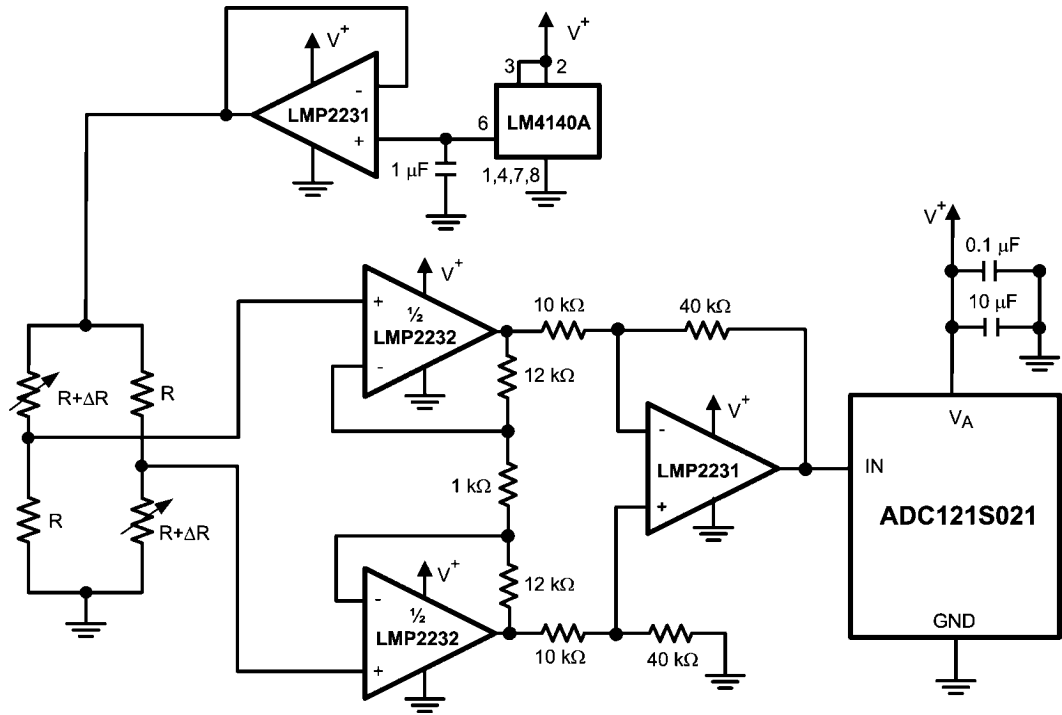

30033874

FIGURE 5. Strain Gauge Bridge Amplifier

PORTABLE GAS DETECTION SENSOR

Gas sensors are used in many different industrial and medical applications. They generate a current which is proportional to the percentage of a particular gas sensed in an air sample. This current goes through a load resistor and the resulting voltage drop is measured. Depending on the sensed gas and sensitivity of the sensor, the output current can be in the order of tens of microamperes to a few milliamperes. Gas sensor datasheets often specify a recommended load resistor value or they suggest a range of load resistors to choose from.

Oxygen sensors are used when air quality or oxygen delivered to a patient needs to be monitored. Fresh air contains 20.9% oxygen. Air samples containing less than 18% oxygen are considered dangerous. Oxygen sensors are also used in industrial applications where the environment must lack oxygen. An example is when food is vacuum packed. There are two main categories of oxygen sensors, those which sense oxygen when it is abundantly present (i.e. in air or near an oxygen tank) and those which detect traces of oxygen in ppm.

Figure 6 shows a typical circuit used to amplify the output of an oxygen detector. The LMP2231 makes an excellent choice for this application as it only draws 10 μA of current and operates on supply voltages down to 1.8V. This application detects oxygen in air. The oxygen sensor outputs a known current through the load resistor. This value changes with the amount of oxygen present in the air sample. Oxygen sensors usually recommend a particular load resistor value or specify a range of acceptable values for the load resistor. Oxygen

sensors typically have a life of one to two years. The use of the micropower LMP2231 means minimal power usage by the op amp and it enhances the battery life. Depending on other components present in the circuit design, the battery could last for the entire life of the oxygen sensor. The precision specifications of the LMP2231, such as its very low offset voltage, low TCV_{OS} , low input bias current, low CMRR, and low PSRR are other factors which make the LMP2231 a great choice for this application.

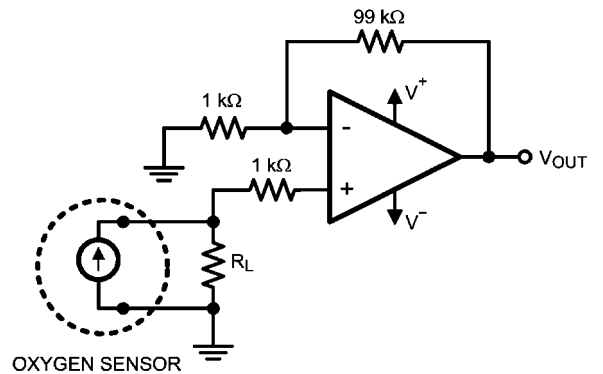

30033849

FIGURE 6. Precision Oxygen Sensor

Physical Dimensions inches (millimeters) unless otherwise noted

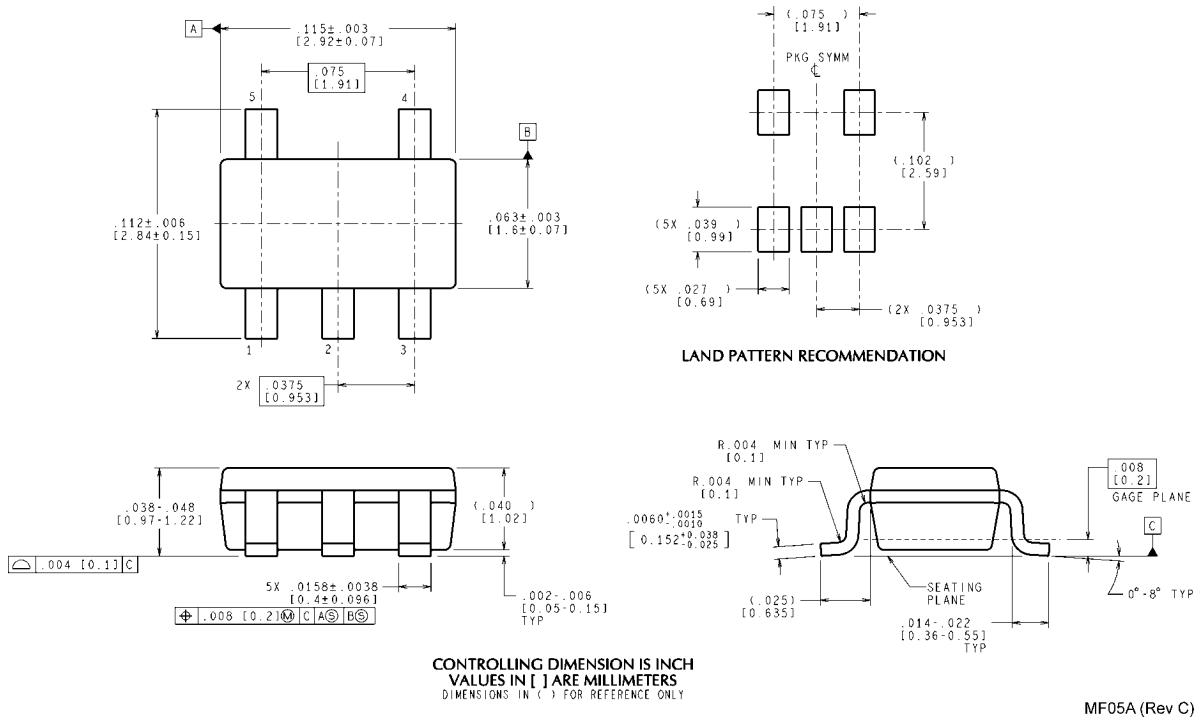

**5-Pin SOT23
NS Package Number MF0A5**

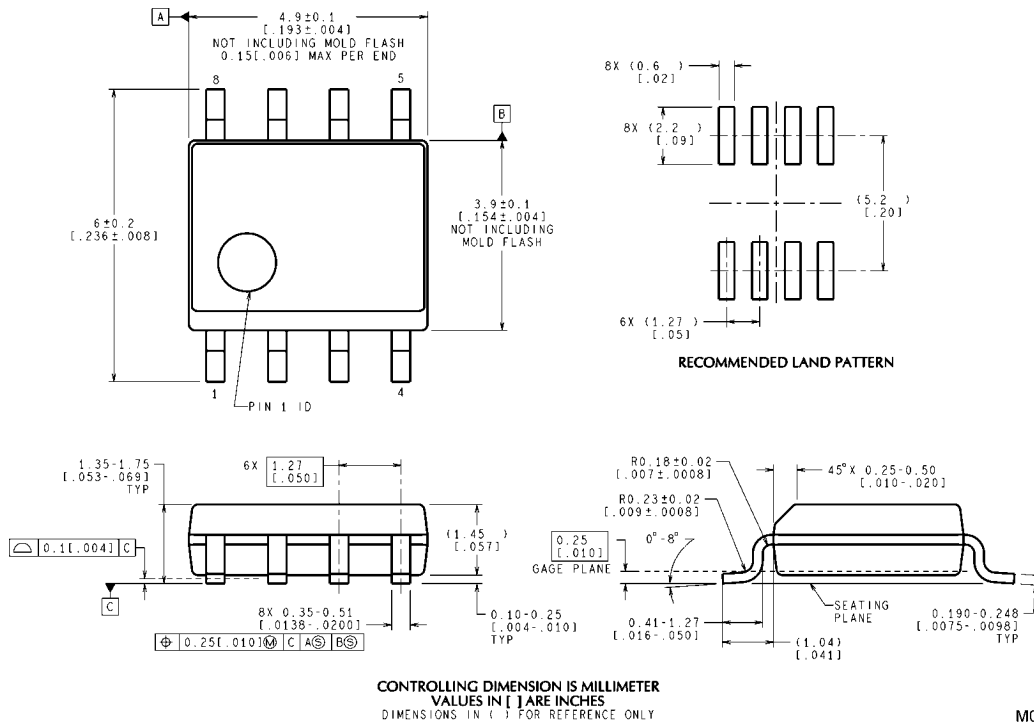

**8-Pin SOIC
NS Package Number M08A**

Notes

For more National Semiconductor product information and proven design tools, visit the following Web sites at:

Products		Design Support	
Amplifiers	www.national.com/amplifiers	WEBENCH	www.national.com/webench
Audio	www.national.com/audio	Analog University	www.national.com/AU
Clock Conditioners	www.national.com/timing	App Notes	www.national.com/appnotes
Data Converters	www.national.com/adc	Distributors	www.national.com/contacts
Displays	www.national.com/displays	Green Compliance	www.national.com/quality/green
Ethernet	www.national.com/ethernet	Packaging	www.national.com/packaging
Interface	www.national.com/interface	Quality and Reliability	www.national.com/quality
LVDS	www.national.com/lvds	Reference Designs	www.national.com/refdesigns
Power Management	www.national.com/power	Feedback	www.national.com/feedback
Switching Regulators	www.national.com/switchers		
LDOs	www.national.com/lido		
LED Lighting	www.national.com/led		
PowerWise	www.national.com/powerwise		
Serial Digital Interface (SDI)	www.national.com/sdi		
Temperature Sensors	www.national.com/tempsensors		
Wireless (PLL/VCO)	www.national.com/wireless		

THE CONTENTS OF THIS DOCUMENT ARE PROVIDED IN CONNECTION WITH NATIONAL SEMICONDUCTOR CORPORATION ("NATIONAL") PRODUCTS. NATIONAL MAKES NO REPRESENTATIONS OR WARRANTIES WITH RESPECT TO THE ACCURACY OR COMPLETENESS OF THE CONTENTS OF THIS PUBLICATION AND RESERVES THE RIGHT TO MAKE CHANGES TO SPECIFICATIONS AND PRODUCT DESCRIPTIONS AT ANY TIME WITHOUT NOTICE. NO LICENSE, WHETHER EXPRESS, IMPLIED, ARISING BY ESTOPPEL OR OTHERWISE, TO ANY INTELLECTUAL PROPERTY RIGHTS IS GRANTED BY THIS DOCUMENT.

TESTING AND OTHER QUALITY CONTROLS ARE USED TO THE EXTENT NATIONAL DEEMS NECESSARY TO SUPPORT NATIONAL'S PRODUCT WARRANTY. EXCEPT WHERE MANDATED BY GOVERNMENT REQUIREMENTS, TESTING OF ALL PARAMETERS OF EACH PRODUCT IS NOT NECESSARILY PERFORMED. NATIONAL ASSUMES NO LIABILITY FOR APPLICATIONS ASSISTANCE OR BUYER PRODUCT DESIGN. BUYERS ARE RESPONSIBLE FOR THEIR PRODUCTS AND APPLICATIONS USING NATIONAL COMPONENTS. PRIOR TO USING OR DISTRIBUTING ANY PRODUCTS THAT INCLUDE NATIONAL COMPONENTS, BUYERS SHOULD PROVIDE ADEQUATE DESIGN, TESTING AND OPERATING SAFEGUARDS.

EXCEPT AS PROVIDED IN NATIONAL'S TERMS AND CONDITIONS OF SALE FOR SUCH PRODUCTS, NATIONAL ASSUMES NO LIABILITY WHATSOEVER, AND NATIONAL DISCLAIMS ANY EXPRESS OR IMPLIED WARRANTY RELATING TO THE SALE AND/OR USE OF NATIONAL PRODUCTS INCLUDING LIABILITY OR WARRANTIES RELATING TO FITNESS FOR A PARTICULAR PURPOSE, MERCHANTABILITY, OR INFRINGEMENT OF ANY PATENT, COPYRIGHT OR OTHER INTELLECTUAL PROPERTY RIGHT.

LIFE SUPPORT POLICY

NATIONAL'S PRODUCTS ARE NOT AUTHORIZED FOR USE AS CRITICAL COMPONENTS IN LIFE SUPPORT DEVICES OR SYSTEMS WITHOUT THE EXPRESS PRIOR WRITTEN APPROVAL OF THE CHIEF EXECUTIVE OFFICER AND GENERAL COUNSEL OF NATIONAL SEMICONDUCTOR CORPORATION. As used herein:

Life support devices or systems are devices which (a) are intended for surgical implant into the body, or (b) support or sustain life and whose failure to perform when properly used in accordance with instructions for use provided in the labeling can be reasonably expected to result in a significant injury to the user. A critical component is any component in a life support device or system whose failure to perform can be reasonably expected to cause the failure of the life support device or system or to affect its safety or effectiveness.

National Semiconductor and the National Semiconductor logo are registered trademarks of National Semiconductor Corporation. All other brand or product names may be trademarks or registered trademarks of their respective holders.

Copyright© 2008 National Semiconductor Corporation

For the most current product information visit us at www.national.com



**National Semiconductor
Americas Technical
Support Center**
Email:
new.feedback@nsc.com
Tel: 1-800-272-9959

**National Semiconductor Europe
Technical Support Center**
Email: europe.support@nsc.com
German Tel: +49 (0) 180 5010 771
English Tel: +44 (0) 870 850 4288

**National Semiconductor Asia
Pacific Technical Support Center**
Email: ap.support@nsc.com

**National Semiconductor Japan
Technical Support Center**
Email: jpn.feedback@nsc.com