

LP2957/LP2957A

5V Low-Dropout Regulator for μ P Applications

General Description

The LP2957 is a 5V micropower voltage regulator with electronic shutdown, error flag, very low quiescent current (150 μ A typical at 1 mA load), and very low dropout voltage (470 mV typical at 250 mA load current).

Output can be wired for snap-on/snap-off operation to eliminate transition voltage states where μ P operation may be unpredictable.

Output crowbar (50 mA typical pull-down current) will bring down the output quickly when the regulator snaps off or when the shutdown function is activated.

The part has tight line and load regulation (0.04% typical) and low output temperature coefficient (20 ppm/ $^{\circ}$ C typical).

The accuracy of the 5V output is guaranteed at room temperature and over the full operating temperature range.

The LP2957 is available in the five-lead TO-220 and TO-263 packages.

Features

- 5V output within 1.4% over temperature (A grade)
- Easily programmed for snap-on/snap-off output
- Guaranteed 250 mA output current
- Extremely low quiescent current
- Low Input-Output voltage required for regulation
- Reverse battery protection
- Extremely tight line and load regulation
- Very low temperature coefficient
- Current and thermal limiting
- Error flag signals when output is out of regulation

Applications

- High-efficiency linear regulator
- Battery-powered regulator

Package Outline

Bent, Staggered Leads
5-Lead TO-220 (T)

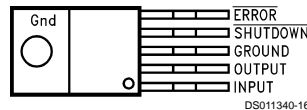

DS011340-16

Top View

Order Number LP2957AIT or LP2957IT
See NS Package Number T05D

Plastic Surface Mount Package
5-Lead TO-263 (S)

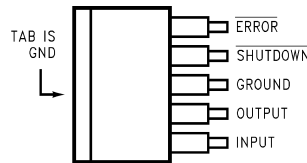

DS011340-17

Top View



DS011340-18

Side View

Order Number LP2957AIS or LP2957IS
See NS Package Number TS5B

Absolute Maximum Ratings (Note 1)

If Military/Aerospace specified devices are required, please contact the National Semiconductor Sales Office/Distributors for availability and specifications.

Operating Junction Temperature Range	-40°C to +125°C
Storage Temperature Range	-65°C to +150°C

Lead Temperature (Soldering, 5 Seconds)	260°C
Power Dissipation (Note 2)	Internally Limited
Input Supply Voltage	-20V to +30V
Shutdown Input	-0.3V to +30V
ESD Rating	2 kV

Electrical Characteristics

Limits in standard typeface are for $T_J = 25^\circ\text{C}$, and limits in **boldface type** apply over the full operating temperature range. Unless otherwise specified: $V_{IN} = 6\text{V}$, $I_L = 1\text{ mA}$, $C_L = 2.2\ \mu\text{F}$, $V_{SD} = 3\text{V}$.

Symbol	Parameter	Conditions	Typical	LP2957AI		LP2957I		Units
				Min	Max	Min	Max	
V_O	Output Voltage (Note 9)		5.0	4.975	5.025	4.950	5.050	V
		$1\text{ mA} \leq I_L \leq 250\text{ mA}$	5.0	4.940	5.060	4.900	5.100	
$\frac{\Delta V_O}{\Delta T}$	Output Voltage Temperature Coefficient	(Note 3)	20		100		150	ppm/°C
$\frac{\Delta V_O}{V_O}$	Line Regulation	$V_{IN} = 6\text{V to }30\text{V}$	0.03		0.10 0.20		0.20 0.40	%
$\frac{\Delta V_O}{V_O}$	Load Regulation	$I_L = 1\text{ mA to }250\text{ mA}$ $I_L = 0.1\text{ mA to }1\text{ mA}$ (Note 4)	0.04		0.16 0.20		0.20 0.30	%
$V_{IN}-V_O$	Dropout Voltage (Note 5)	$I_L = 1\text{ mA}$	60		100 150		100 150	mV
		$I_L = 50\text{ mA}$	240		300 420		300 420	
		$I_L = 100\text{ mA}$	310		400 520		400 520	
		$I_L = 250\text{ mA}$	470		600 800		600 800	
I_{GND}	Ground Pin Current (Note 6)	$I_L = 1\text{ mA}$	150		200 230		200 230	μA
		$I_L = 50\text{ mA}$	1.1		2 2.5		2 2.5	mA
		$I_L = 100\text{ mA}$	3		6 8		6 8	
		$I_L = 250\text{ mA}$	16		28 33		28 33	
I_{GND}	Ground Pin Current in Shutdown (Note 6)	$I_L = 0$ $V_{SD} = 0.4\text{V}$	130		180 200		180 200	μA
I_{GND}	Ground Pin Current at Dropout (Note 6)	$V_{IN} = 4.5\text{V}$ $I_L = 0.1\text{ mA}$	180		230 250		230 250	μA
I_O (Sink)	Off-State Output Pulldown Current	$V_{IN} = 5.3\text{V}$ $V_O = 5\text{V}$, $V_{SD} = 0.4\text{V}$	50	30 20		30 20		mA
I_O (Off)	Output Leakage in Shutdown	$I_{(SD\ IN)} \geq 1\ \mu\text{A}$ $V_{IN} = 30\text{V}$, $V_{OUT} = 0\text{V}$	3		10 20		10 20	μA
I_{LIMIT}	Current Limit	$R_L = 1\ \Omega$	400		500 530		500 530	mA
$\frac{\Delta V_O}{\Delta P_d}$	Thermal Regulation	(Note 7)	0.05		0.2		0.2	%/W

Electrical Characteristics (Continued)

Limits in standard typeface are for $T_J = 25^\circ\text{C}$, and limits in **boldface type** apply over the full operating temperature range. Unless otherwise specified: $V_{IN} = 6\text{V}$, $I_L = 1\text{ mA}$, $C_L = 2.2\ \mu\text{F}$, $V_{SD} = 3\text{V}$.

Symbol	Parameter	Conditions	Typical	LP2957AI		LP2957I		Units
				Min	Max	Min	Max	
e_n	Output Noise Voltage (10 Hz to 100 kHz) $I_L = 100\text{ mA}$	$C_L = 2.2\ \mu\text{F}$	500					μV RMS
		$C_L = 33\ \mu\text{F}$	320					
SHUTDOWN INPUT								
$V_{SD}(\text{ON})$	Output Turn-On Threshold Voltage			1.155 1.140	1.305 1.320	1.155 1.140	1.305 1.320	V
HYST	Hysteresis		6					mV
I_B	Input Bias Current	$V_{IN(\text{SD})} = 0\text{V to }5\text{V}$	10	-30 -50	30 50	-30 -50	30 50	nA
DROPOUT DETECTION COMPARATOR								
I_{OH}	Output "HIGH" Leakage	$V_{OH} = 30\text{V}$	0.01		1 2		1 2	μA
V_{OL}	Output "LOW" Voltage	$V_{IN} = 4\text{V}$ $I_O(\text{COMP}) = 400\ \mu\text{A}$	150		250 400		250 400	mV
V_{THR} (Max)	Upper Threshold Voltage	(Note 8)	-240	-320 -380	-150 -100	-320 -380	-150 -100	mV
V_{THR} (Min)	Lower Threshold Voltage	(Note 8)	-350	-450 -640	-230 -160	-450 -640	-230 -160	mV
HYST	Hysteresis	(Note 8)	60					mV

Note 1: Absolute maximum ratings indicate limits beyond which damage to the component may occur. Electrical specifications do not apply when operating the device outside of its rated operating conditions.

Note 2: The maximum allowable power dissipation is a function of the maximum junction temperature, $T_J(\text{MAX})$, the junction-to-ambient thermal resistance, θ_{JA} , and the ambient temperature, T_A . The maximum allowable power dissipation at any ambient temperature is calculated using:

$$P(\text{MAX}) = \frac{T_J(\text{MAX}) - T_A}{\theta_{JA}}$$

Exceeding the maximum allowable power dissipation will result in excessive die temperature, and the regulator will go into thermal shutdown. The junction-to-ambient thermal resistance of the TO-220 (without heatsink) is 60°C/W and 73°C/W for the TO-263. If the TO-263 package is used, the thermal resistance can be reduced by increasing the P.C. board copper area thermally connected to the package: Using 0.5 Square inches of copper area, θ_{JA} is 50°C/W , with 1 square inch of copper area, θ_{JA} is 37°C/W ; and with 1.6 or more square inches of copper area, θ_{JA} is 32°C/W . The junction-to-case thermal resistance is 3°C/W . If an external heatsink is used, the effective junction-to-ambient thermal resistance is the sum of the junction-to-case resistance (3°C/W), the specified thermal resistance of the heatsink selected, and the thermal resistance of the interface between the heatsink and the LP2957 (see Application Hints).

Note 3: Output voltage temperature coefficient is defined as the worst case voltage change divided by the total temperature range.

Note 4: Regulation is measured at constant junction temperature using low duty cycle pulse testing. Parts are tested separately for load regulation in the load ranges 0.1 mA–1 mA and 1 mA–250 mA. Changes in output voltage due to heating effects are covered by the thermal regulation specification.

Note 5: Dropout voltage is defined as the input to output voltage differential at which the output voltage drops 100 mV below the value measured with a 1V input to output differential.

Note 6: Ground pin current is the regulator quiescent current. The total current drawn from the source is the sum of the load current plus the ground pin current.

Note 7: Thermal regulation is defined as the change in output voltage at a time T after a change in power dissipation is applied, excluding load or line regulation effects. Specifications are for a 200 mA load pulse at $V_{IN} = 20\text{V}$ (3W pulse) for $T = 10\text{ ms}$.

Note 8: Voltages are referenced to the nominal regulated output voltage.

Note 9: When used in dual-supply systems where the regulator load is returned to a negative supply, the output voltage must be diode-clamped to ground.

Typical Performance Characteristics Unless otherwise specified: $V_{IN} = 6V$, $I_L = 1\text{ mA}$, $C_L = 2.2\ \mu\text{F}$, $V_{SD} = 3V$, $T_A = 25^\circ\text{C}$

Ground Pin Current

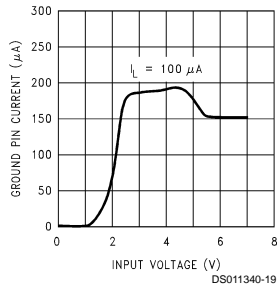

Ground Pin Current

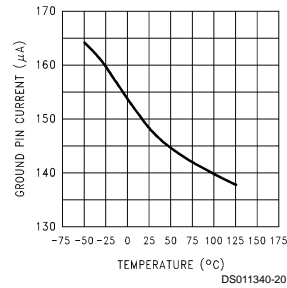

Ground Pin Current vs Load

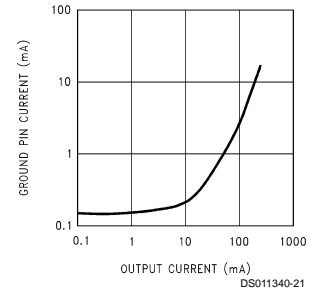

Ground Pin Current

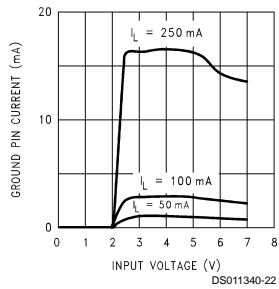

Ground Pin Current

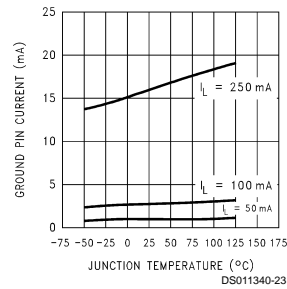

Output Noise Voltage

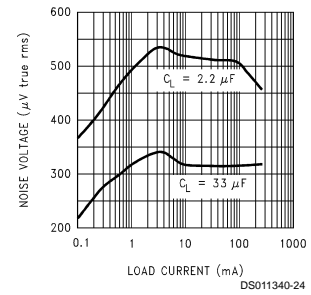

Ripple Rejection

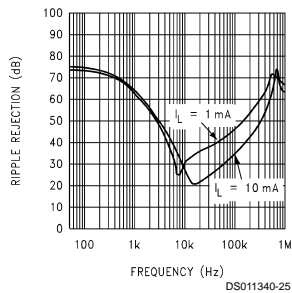

Ripple Rejection

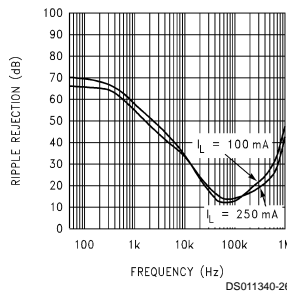

Ripple Rejection

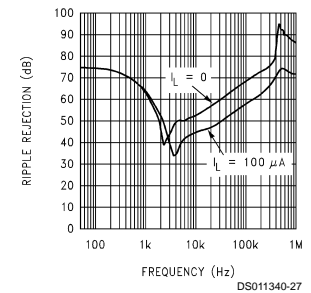

Line Transient Response

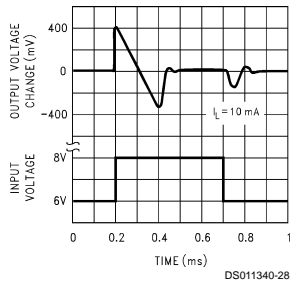

Line Transient Response

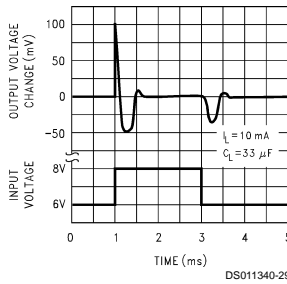

Output Impedance

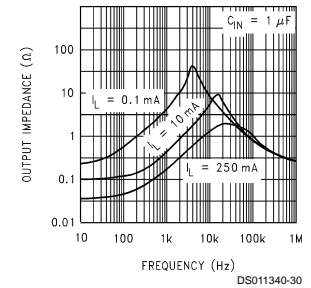

Typical Performance Characteristics Unless otherwise specified: $V_{IN} = 6V$, $I_L = 1\text{ mA}$, $C_L = 2.2\text{ }\mu\text{F}$, $V_{SD} = 3V$, $T_A = 25^\circ\text{C}$ (Continued)

Load Transient Response

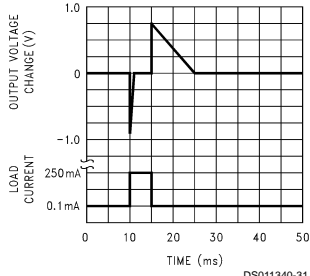

DS011340-31

Load Transient Response

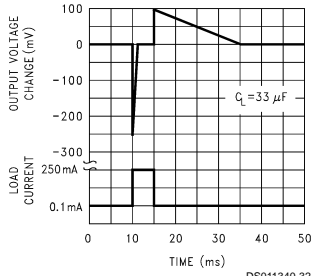

DS011340-32

Dropout Characteristics

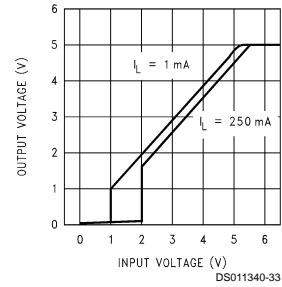

DS011340-33

Enable Transient

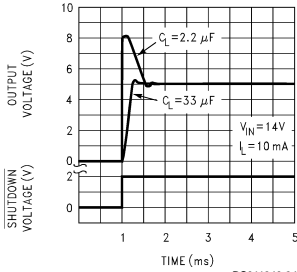

DS011340-34

Enable Transient

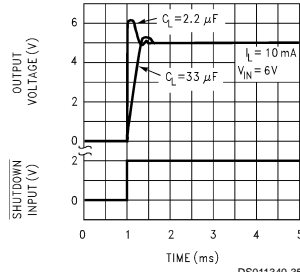

DS011340-35

Short-Circuit Output Current and Maximum Output Current

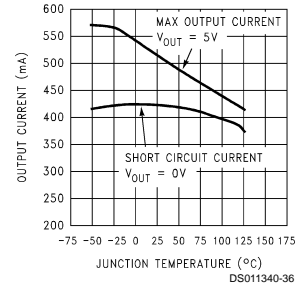

DS011340-36

Thermal Regulation

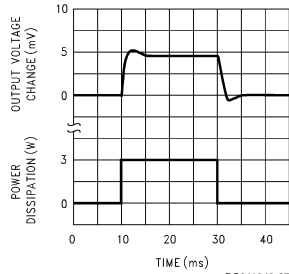

DS011340-37

Error Output Sink Current

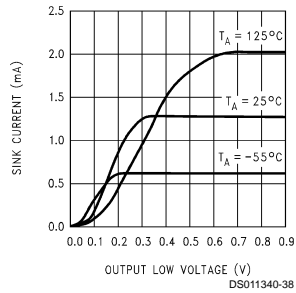

DS011340-38

Dropout Detection Threshold Voltages

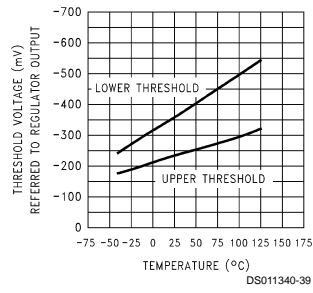

DS011340-39

Typical Performance Characteristics Unless otherwise specified: $V_{IN} = 6V$, $I_L = 1\text{ mA}$, $C_L = 2.2\ \mu F$, $V_{SD} = 3V$, $T_A = 25^\circ C$ (Continued)

Maximum Power Dissipation (TO-263) (Note 2)

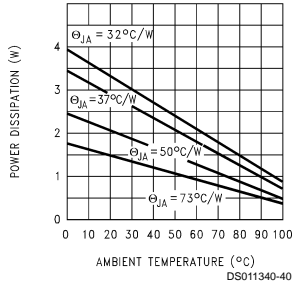

Error Output Voltage

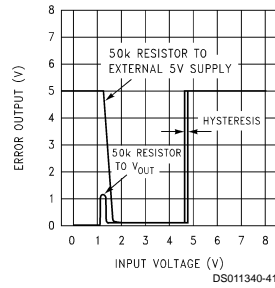

Dropout Voltage

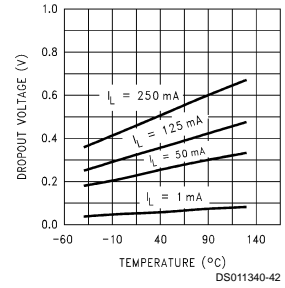

Block Diagram

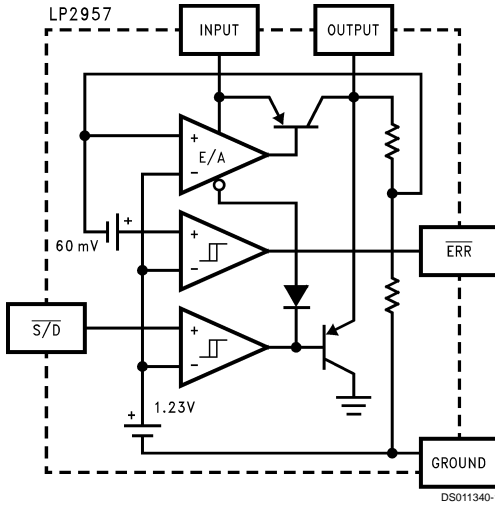

Typical Application Circuits

LP2957 Basic Application

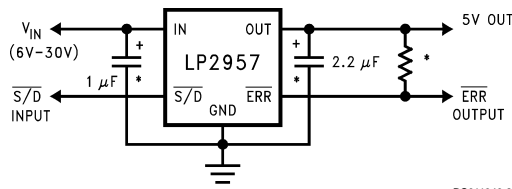

Typical Application Circuits (Continued)

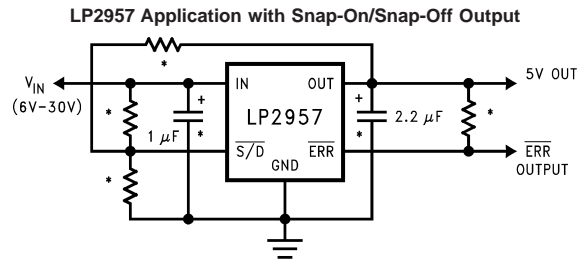

*See Application Hints

Application Hints

EXTERNAL CAPACITORS

A 2.2 μF (or greater) capacitor is required between the output pin and ground to assure stability (refer to *Figure 1*). Without this capacitor, the part may oscillate. Most type of tantalum or aluminum electrolytics will work here. Film types will work, but are more expensive. Many aluminum electrolytics contain electrolytes which freeze at -30°C , which requires the use of solid tantalums below -25°C . The important parameters of the capacitor are an ESR of about 5Ω or less and a resonant frequency above 500 kHz (the ESR may increase by a factor of **20** or **30** as the temperature is reduced from 25°C to -30°C). The value of this capacitor may be increased without limit. At lower values of output current, less output capacitance is required for stability. The capacitor can be reduced to 0.68 μF for currents below 10 mA or 0.22 μF for currents below 1 mA.

A 1 μF capacitor should be placed from the input pin to ground if there is more than 10 inches of wire between the input and the AC filter capacitor or if a battery input is used. This capacitor may have to be increased if the regulator is wired for snap-on/snap-off output and the source impedance is high (see *Snap-On/Snap-Off Operation* section).

SHUTDOWN INPUT

A logic-level signal will shut off the regulator output when a "LOW" ($< 1.2\text{V}$) is applied to the Shutdown input.

To prevent possible mis-operation, the Shutdown input must be actively terminated. If the input is driven from open-collector logic, a pull-up resistor (20 k Ω to 100 k Ω recommended) must be connected from the Shutdown input to the regulator input.

If the Shutdown input is driven from a source that actively pulls high and low (like an op-amp), the pull-up resistor is not required, but may be used.

If the shutdown function is not to be used, the cost of the pull-up resistor can be saved by tying the Shutdown input directly to the regulator input.

IMPORTANT: Since the Absolute Maximum Ratings state that the Shutdown input can not go more than 0.3V below ground, the reverse-battery protection feature which protects the regulator input is sacrificed if the Shutdown input is tied directly to the regulator input.

If reverse-battery protection is required in an application, the pull-up resistor between the Shutdown input and the regulator input must be used.

MINIMUM LOAD

It should be noted that a minimum load current is specified in several of the electrical characteristic test conditions, so the value listed must be used to obtain correlation on these tested limits. The part is parametrically tested down to 100 μA , but is functional with no load.

DROPOUT VOLTAGE

The dropout voltage of the regulator is defined as the minimum input-to-output voltage differential required for the output voltage to stay within 100 mV of the output voltage measured with a 1V differential. The dropout voltages for various values of load current are listed under Electrical Characteristics.

If the regulator is powered from a transformer connected to the AC line, the **minimum AC line voltage** and **maximum load current** must be used to measure the minimum voltage at the input of the regulator. The minimum input voltage is the lowest voltage level **including ripple on the filter capacitor**. It is also advisable to verify operation at **minimum operating ambient temperature**, since the increasing ESR of the filter capacitor makes this a worst-case test due to increased ripple amplitude.

HEATSINK REQUIREMENTS

A heatsink may be required with the LP2957 depending on the maximum power dissipation and maximum ambient temperature of the application. Under all possible operating conditions, the junction temperature must be within the range specified under Absolute Maximum Ratings.

To determine if a heatsink is required, the maximum power dissipated by the regulator, $P(\text{max})$, must be calculated. It is important to remember that if the regulator is powered from a transformer connected to the AC line, the **maximum specified AC input voltage** must be used (since this produces the maximum DC input voltage to the regulator), and the **maximum load current** must also be used. *Figure 1* shows the voltages and currents which are present in the circuit. The formula for calculating the power dissipated in the regulator is also shown in *Figure 1*.

Application Hints (Continued)

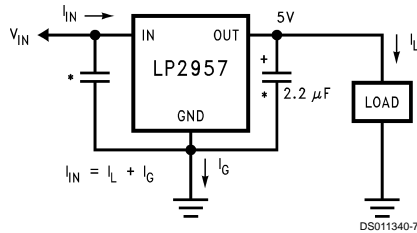

$P_{TOTAL} = (V_{IN} - 5V) I_L + (V_{IN}) I_G$
 *See EXTERNAL CAPACITORS

FIGURE 1. Basic 5V Regulator Circuit

The next parameter which must be calculated is the maximum allowable temperature rise, $T_R(\text{Max})$. This is calculated by using the formula:

$$T_R(\text{Max}) = T_J(\text{Max}) - T_A(\text{Max})$$

where: $T_J(\text{Max})$ is the maximum allowable junction temperature

$T_A(\text{Max})$ is the maximum ambient temperature

Using the calculated values for $T_R(\text{Max})$ and $P(\text{Max})$, the required value for junction-to-ambient thermal resistance, $\theta_{(JA)}$, can now be found:

$$\theta_{(JA)} = T_R(\text{Max})/P(\text{Max})$$

If the calculated value is **60°C/W or higher**, the regulator may be operated without an external heatsink. If the calculated value is **below 60°C/W**, an external heatsink is required. The required thermal resistance for this heatsink, $\theta_{(HA)}$, can be calculated using the formula:

$$\theta_{(HA)} = \theta_{(JA)} - \theta_{(JC)} - \theta_{(CH)}$$

where:

$\theta_{(JC)}$ is the junction-to-case thermal resistance, which is specified as 3°C/W for the LP2957.

$\theta_{(CH)}$ is the case-to-heatsink thermal resistance, which is dependent on the interfacing material (see *Table 1* and *Table 2*).

Typical TO-220 Case-To-Heatsink Thermal Resistance in °C/W

TABLE 1. (From AAVID)

Silicone Grease	1.0
Dry Interface	1.3
Mica with Grease	1.4

TABLE 2. (From Thermalloy)

Thermasil III	1.3
Thermasil II	1.5
Thermalfilm (0.002) with Grease	2.2

$\theta_{(HA)}$ is the heatsink-to-ambient thermal resistance. It is this specification (listed on the heatsink manufacturers data sheet) which defines the effectiveness of the heatsink. The heatsink selected must have a thermal resistance which is **equal to or lower** than the value of $\theta_{(HA)}$ calculated from the above listed formula.

ERROR COMPARATOR

This comparator produces a logic "LOW" whenever the output falls out of regulation by more than about 5%. This figure results from the comparator's built-in offset of 60 mV divided by the 1.23V reference. An out-of-regulation condition can result from low input voltage, current limiting, or thermal limiting.

Figure 2 gives a timing diagram showing the relationship between the output voltage, the $\overline{\text{ERROR}}$ output, and input voltage as the input voltage is ramped up and down to the regulator **without snap-on/snap-off output**. The $\overline{\text{ERROR}}$ signal becomes low at about 1.3V input. It goes high at about 5V input, where the output equals 4.75V. Since the dropout voltage is load dependent, the **input** voltage trip points will vary with load current. The **output** voltage trip point does not vary.

The comparator has an open-collector output which requires an external pull-up resistor. This resistor may be connected to the regulator output or some other supply voltage. Using the regulator output prevents an invalid "HIGH" on the comparator output which occurs if it is pulled up to an external voltage while the regulator input voltage is reduced below 1.3V. In selecting a value for the pull-up resistor, note that while the output can sink 400 μA , this current adds to battery drain. Suggested values range from 100k to 1 M Ω . The resistor is not required if the output is unused.

Application Hints (Continued)

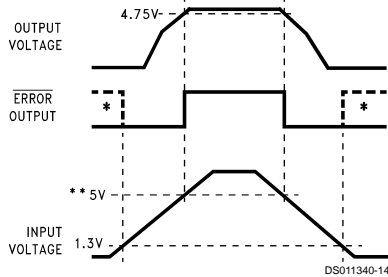

*In shutdown mode, **ERROR** will go high if it has been pulled up to an external supply. To avoid this invalid response, pull up to regulator output.
**Exact value depends on dropout voltage, which varies with load current.

FIGURE 2. ERROR Output Timing

If a single pull-up resistor is connected to the regulator output, the error flag may briefly rise up to about 1.3V as the input voltage ramps up or down through the 0V to 1.3V region. In some cases, this 1.3V signal may be mis-interpreted as a false high by a μ P which is still "alive" with 1.3V applied to it. To prevent this, the user may elect to use **two** resistors which are equal in value on the error output (one connected to ground and the other connected to the regulator output). If this two-resistor divider is used, the error output will only be pulled up to about 0.6V (not 1.3V) during power-up or power-down, so it can not be interpreted as a high signal. When the regulator output is in regulation (4.8V to 5V), the error output voltage will be 2.4V to 2.5V, which is clearly a high signal.

OUTPUT ISOLATION

The regulator output can be connected to an active voltage source (such as a battery) with the regulator input turned off, **as long as the regulator ground pin is connected to ground**. If the ground pin is left floating, **damage to the regulator can occur** if the output is pulled up by an external voltage source.

SNAP-ON/SNAP-OFF OPERATION

The LP2957 output can be wired for snap-on/snap-off operation using three external resistors:

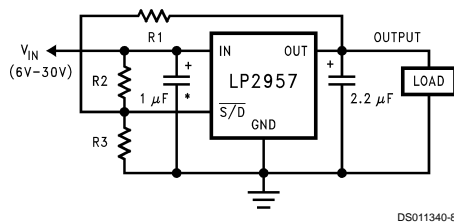

*Minimum value (increase as required for smooth turn-on characteristic).

FIGURE 3. Snap-On/Snap-Off Output

When connected as shown, the shutdown input holds the regulator off until the input voltage rises up to the turn-on threshold (V_{ON}), at which point the output "snaps on".

When the input power is shut off (and the input voltage starts to decay) the output voltage will snap off when the input voltage reaches the turn-off threshold, V_{OFF} .

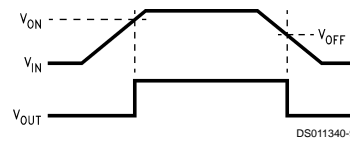

FIGURE 4. Snap-On/Snap-Off Input and Output Voltage Diagram

It is important to note that the voltage V_{OFF} must always be lower than V_{ON} (the difference in these voltage levels is called the hysteresis).

Hysteresis is **required** when using snap-on/snap-off output, with the minimum amount of hysteresis required for a specific application being dependent on the source impedance of whatever is supplying V_{IN} .

Caution: A type of **low-frequency oscillation** can occur if V_{ON} and V_{OFF} are too close together (**insufficient hysteresis**). When the output snaps on, the regulator must draw sufficient current to power the load and charge up the output capacitor (in most cases, the regulator will briefly draw the maximum current allowed by its internal limiter).

For this reason, it is best to assume the LP2957 may pull a peak current of about **600 mA** from the source (which is the listed maximum short-circuit load current of **530 mA** plus the ground pin current of **70 mA**).

This high peak current causes V_{IN} to drop by an amount equal to the source impedance multiplied by the current. If V_{IN} drops below V_{OFF} , the regulator will turn off and stop drawing current from the source. This will allow V_{IN} to rise back up above V_{ON} , and the cycle will start over. The regulator will stay in this oscillating mode and never come into regulation.

HYSTERESIS IN TRANSFORMER-POWERED APPLICATIONS:

If the unregulated DC input voltage to the regulator comes from a transformer, the required hysteresis is easily measured by loading the source with a resistive load.

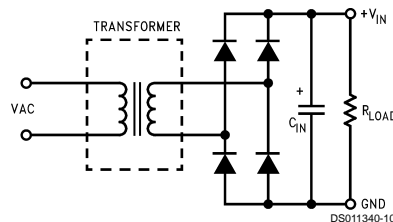

FIGURE 5. Transformer Powered Input Supply

If the regulator is powered from a battery, the source impedance will probably be low enough that other considerations will determine the optimum values for hysteresis (see Design Example #2).

For best results, the load resistance used to test the transformer should be selected to draw about **600 mA** for the maximum load current test, since this is the maximum peak current the LP2957 could be expected to draw from the source.

Application Hints (Continued)

The difference in input voltage measured at no load and full load defines the amount of hysteresis required for proper snap-on/snap-off operation (the programmed hysteresis must be greater than the difference in voltages).

CALCULATING RESISTOR VALUES:

The values of R1, R2 and R3 can be calculated assuming the designer knows the hysteresis.

In most transformer-powered applications, it can be assumed that V_{OFF} (the input voltage at turn-off) should be set for about 5.5V, since this allows about 500 mV across the LP2957 to keep the output in regulation until it snaps off. V_{ON} (the input voltage at turn on) is found by adding the hysteresis voltage to V_{OFF} .

R1, R2 and R3 are found by solving the node equations for the currents entering the node nearest the shutdown pin (written at the turn-on and turn-off thresholds).

The shutdown pin bias current (10 nA typical) is not included in the calculations:

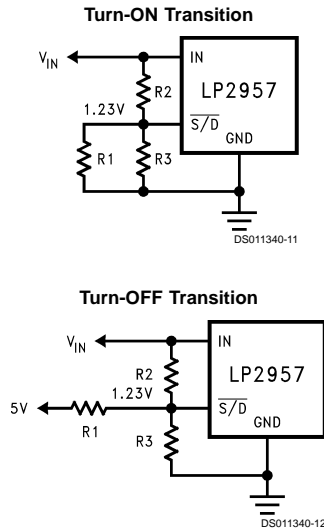

FIGURE 6. Equivalent Circuits

$$\left(\frac{V_{ON} - 1.23}{R2} \right) = \frac{1.23}{R1} + \frac{1.23}{R3} \quad (\text{TURN-ON})$$

$$\frac{V_{OFF} - 1.23}{R2} + \frac{5 - 1.23}{R1} = \frac{1.23}{R3} \quad (\text{TURN-OFF})$$

Since these two equations contain three unknowns (R1, R2 and R3) one resistor value must be assumed and then the remaining two values can be obtained by solving the equations.

The node equations will be simplified by solving both equations for R2, and then equating the two to generate an expression in terms of R1 and R3.

$$R2 = \frac{(R1 \times R3) \times (V_{ON} - 1.23)}{1.23 \times (R1 + R3)} \quad (\text{TURN-ON})$$

$$R2 = \frac{(R1 \times R3) \times (V_{OFF} - 1.23)}{(1.23R1 - 3.77R3)} \quad (\text{TURN-OFF})$$

Setting these equal to each other and solving for R1 yields:

$$R1 = \frac{R3 \times (V_{OFF} + 3.07V_{ON} - 5)}{V_{ON} - V_{OFF}}$$

The same equation solved for R3 is:

$$R3 = \frac{R1 \times (V_{ON} - V_{OFF})}{V_{OFF} + 3.07V_{ON} - 5}$$

A value for R1 or R3 can be derived using either one of the above equations, if the designer assumes a value for one of the resistors.

The simplest approach is to assume a value for R3. Best results will typically be obtained using values between about 20 kΩ and 100 kΩ (this keeps the current drain low, but also generates realistic values for the other resistors).

There is no limit on the minimum value of R3, but current should be minimized as it generates power that drains the source and does not power the load.

SUMMARY: TO SOLVE FOR R1, R2 AND R3:

1. Assume a value for either R1 or R3.
2. Solve for the other variable using the equation for R1 or R3.
3. Take the values for R1 and R3 and plug them back into either equation for R2 and solve for this value.

DESIGN EXAMPLE #1:

A 5V regulated output is to be powered from a transformer secondary which is rectified and filtered. The voltage V_{IN} is measured at zero current and maximum current (600 mA) to determine the minimum allowable hysteresis.

V_{IN} is measured using an oscilloscope (both traces are shown on the same grid for clarity):

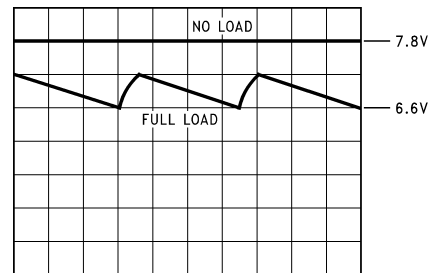

FIGURE 7. V_{IN} VOLTAGE WAVEFORMS

The full-load voltage waveform from a transformer-powered supply will have ripple voltage as shown. The correct point to measure is the lowest value of the waveform.

The 1.2V differential between no-load and full-load conditions means that at least 1.2V of hysteresis is required for proper snap-on/snap-off operation (for this example, we will use 1.5V).

As a starting point, we will assume:

$$V_{OFF} = 5.5V$$

$$V_{ON} = V_{OFF} + HYST = 5.5 + 1.5 = 7V$$

$$R3 = 49.9k$$

Solving for R1:

Application Hints (Continued)

$$R1 = \frac{R3 \times (V_{OFF} + 3.07V_{ON} - 5)}{V_{ON} - V_{OFF}}$$

$$R1 = \frac{49.9k \times (5.5 + (3.07 \times 7) - 5)}{7 - 5.5}$$

$$\mathbf{R1 = 731k \text{ (standard size 732k)}}$$

Solving for R2:

$$R2 = \frac{(R1 \times R3) \times V_{ON} - 1.23}{1.23 \times (R1 + R3)}$$

$$R2 = \frac{(732k \times 49.9k) \times (7 - 1.23)}{1.23 \times (732k + 49.9k)}$$

$$\mathbf{R2 = 219k \text{ (standard size 221k)}}$$

DESIGN EXAMPLE #2:

A 5V regulated output is to be powered from a battery made up of six NiCad cells. The cell data is:

cell voltage (full charged): 1.4V

cell voltage (90% discharged): 1.0V

The internal impedance of a typical battery is low enough that source loading during regulator turn-on is not usually a problem.

In a battery-powered application, the turn-off voltage V_{OFF} should be selected so that the regulator is shut down when the batteries are about 90% discharged (over discharge can damage rechargeable batteries).

In this case, the battery voltage will be **6.0V** at the 90% discharge point (since there are six cells at 1.0V each). That means for this application, V_{OFF} will be set to 6.0V.

Selecting the optimum voltage for V_{ON} requires understanding battery behavior. If a Ni-Cad battery is nearly discharged

(cell voltage 1.0V) **and the load is removed**, the cell voltage will drift back up. The voltage where the regulator turns on must be set high enough to keep the regulator from re-starting during this time, or an on-off pulsing mode can occur.

If the regulator restarts when the discharged cell voltage drifts up, the load on the battery will cause the cell voltage to fall below the turn-off level, which causes the regulator to shut down. The cell voltage will again float up and the on-off cycling will continue.

For NiCad batteries, a good cell voltage to use to calculate V_{ON} is about 1.2V per cell. In this application, this will yield a value for V_{ON} of 7.2V.

We can now find R1, R2 and R3 assuming:

$$\mathbf{V_{OFF} = 6.0V \quad V_{ON} = 7.2V \quad R3 = 49.9k}$$

Solving for R1:

$$R1 = \frac{R3 \times (V_{OFF} + 3.07V_{ON} - 5)}{V_{ON} - V_{OFF}}$$

$$R1 = \frac{49.9k \times (6 + (3.07 \times 7.2) - 5)}{7.2 - 6}$$

$$\mathbf{R1 = 961k \text{ (standard size 953k)}}$$

Solving for R2:

$$R2 = \frac{(R1 \times R3) \times (V_{ON} - 1.23)}{1.23 \times (R1 + R3)}$$

$$R2 = \frac{(953k \times 49.9k) \times (7.2 - 1.23)}{1.23 \times (953k + 49.9k)}$$

$$\mathbf{R2 = 230k \text{ (standard size 232k)}}$$

Schematic Diagram

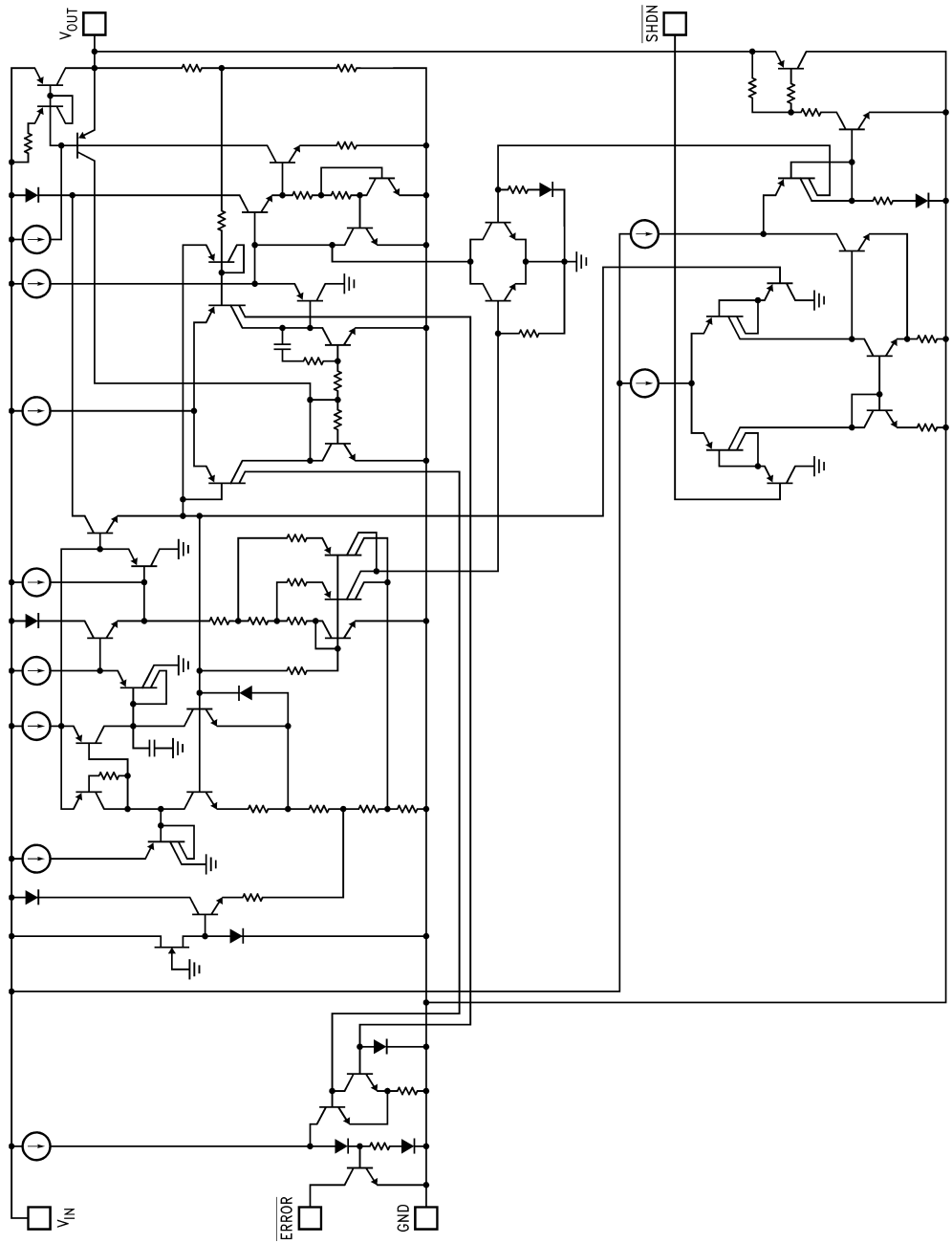

DS011340-15

Physical Dimensions inches (millimeters) unless otherwise noted

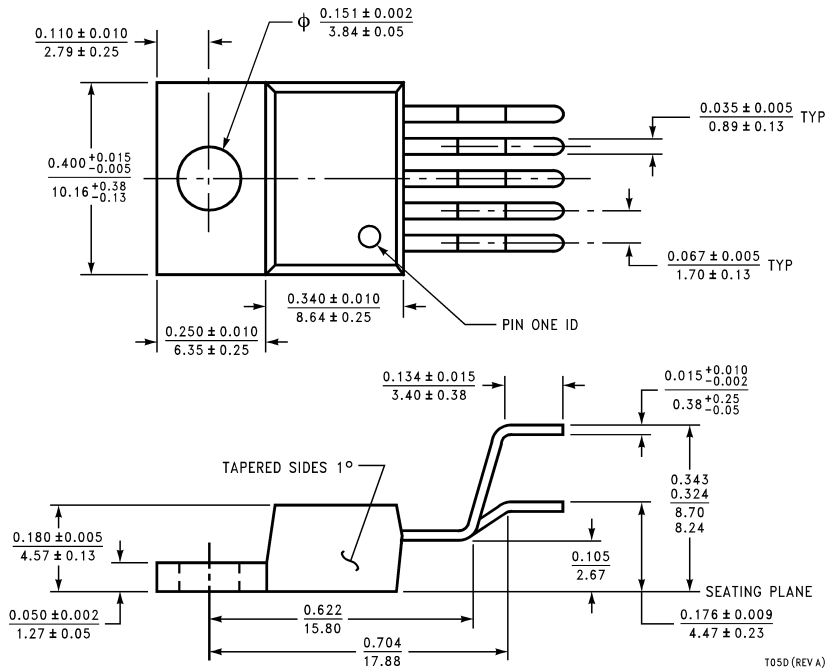

Bent, Staggered 5-Lead TO-220 (T)
Order Number LP2957AIT or LP2957IT
NS Package Number T05D

Physical Dimensions inches (millimeters) unless otherwise noted (Continued)

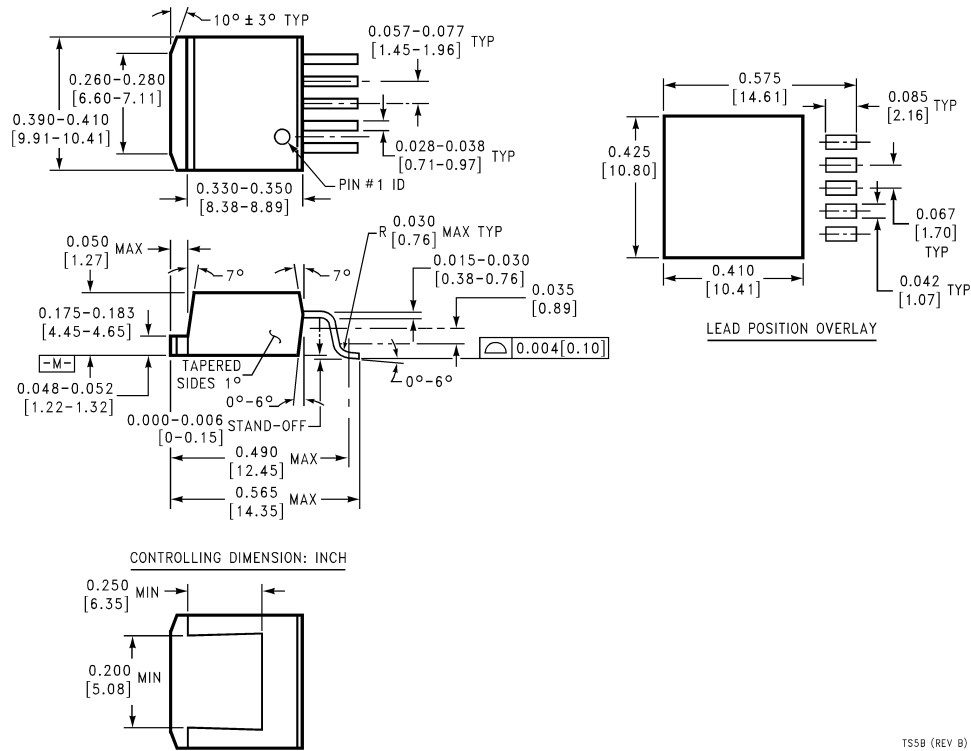

TO-263 5-Lead Plastic Surface Mount Package
 Order Number LP2957AIS or LP2957IS
 NS Package Number TS5B

TS5B (REV B)

LIFE SUPPORT POLICY

NATIONAL'S PRODUCTS ARE NOT AUTHORIZED FOR USE AS CRITICAL COMPONENTS IN LIFE SUPPORT DEVICES OR SYSTEMS WITHOUT THE EXPRESS WRITTEN APPROVAL OF THE PRESIDENT AND GENERAL COUNSEL OF NATIONAL SEMICONDUCTOR CORPORATION. As used herein:

1. Life support devices or systems are devices or systems which, (a) are intended for surgical implant into the body, or (b) support or sustain life, and whose failure to perform when properly used in accordance with instructions for use provided in the labeling, can be reasonably expected to result in a significant injury to the user.
2. A critical component is any component of a life support device or system whose failure to perform can be reasonably expected to cause the failure of the life support device or system, or to affect its safety or effectiveness.



National Semiconductor Corporation
 Americas
 Tel: 1-800-272-9959
 Fax: 1-800-737-7018
 Email: support@nsc.com

www.national.com

National Semiconductor Europe

Fax: +49 (0) 1 80-530 85 86
 Email: europe.support@nsc.com
 Deutsch Tel: +49 (0) 1 80-530 85 85
 English Tel: +49 (0) 1 80-532 78 32
 Français Tel: +49 (0) 1 80-532 93 58
 Italiano Tel: +49 (0) 1 80-534 16 80

National Semiconductor Asia Pacific Customer Response Group

Tel: 65-2544466
 Fax: 65-2504466
 Email: sea.support@nsc.com

National Semiconductor Japan Ltd.

Tel: 81-3-5639-7560
 Fax: 81-3-5639-7507