

## 12-BIT, 200-KSPS, 11-CHANNEL, LOW-POWER, SERIAL ADC

### FEATURES

- 12-Bit-Resolution A/D Converter
- Up to 200 KSPS (150 KSPS for 3 V) Throughput Over Operating Temperature Range With 12-Bit Output Mode
- 11 Analog Input Channels
- 3 Built-In Self-Test Modes
- Inherent Sample and Hold Function
- Linearity Error . . .  $\pm 1$  LSB Max
- On-Chip Conversion Clock
- Unipolar or Bipolar Output Operation
- Programmable MSB or LSB First
- Programmable Power Down
- Programmable Output Data Length
- SPI Compatible Serial Interface With I/O Clock Frequencies up to 15 MHz (CPOL=0, CPHA=0)

### APPLICATIONS

- Process Control
- Portable Data Logging
- Battery-Powered Instruments
- Automotive

### DESCRIPTION

The TLV2553 is a 12-bit, switched-capacitor, successive-approximation, analog-to-digital converter. The ADC has three control inputs [chip select ( $\overline{CS}$ ), the input-output clock, and the address/control input (DATAIN)], designed for communication with the serial port of a host processor or peripheral through a serial 3-state output.

In addition to the high-speed converter and versatile control capability, the device has an on-chip 14-channel multiplexer that can select any one of 11 inputs or any one of three internal self-test voltages using configuration register 1. The sample-and-hold function is automatic. At the end of conversion, when programmed as EOC, the pin 19 output goes high to indicate that conversion is complete. The converter incorporated in the device features differential, high-impedance reference inputs that facilitate ratiometric conversion, scaling, and isolation of analog circuitry from logic and supply noise. A switched-capacitor design allows low-error conversion over the full operating temperature range.

The TLV2553I is characterized for operation from  $T_A = -40^\circ\text{C}$  to  $85^\circ\text{C}$ . See available options table for package options.

DW AND PW PACKAGE  
(TOP VIEW)

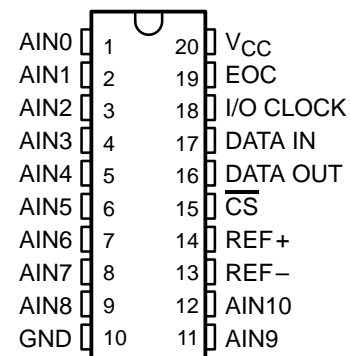

Please be aware that an important notice concerning availability, standard warranty, and use in critical applications of Texas Instruments semiconductor products and disclaimers thereto appears at the end of this data sheet.

PRODUCTION DATA information is current as of publication date. Products conform to specifications per the terms of Texas Instruments standard warranty. Production processing does not necessarily include testing of all parameters.

Copyright © 2002, Texas Instruments Incorporated

# TLV2553

SLAS354B – SEPTEMBER 2001 – REVISED SEPTEMBER 2002

## AVAILABLE OPTIONS

T <sub>A</sub>	PACKAGE	
	SMALL OUTLINE	
	20-TSSOP (PW)	20-SOWB (DW)
-40°C to 85°C	TLV2553IPW	TLV2553IDW

## functional block diagram

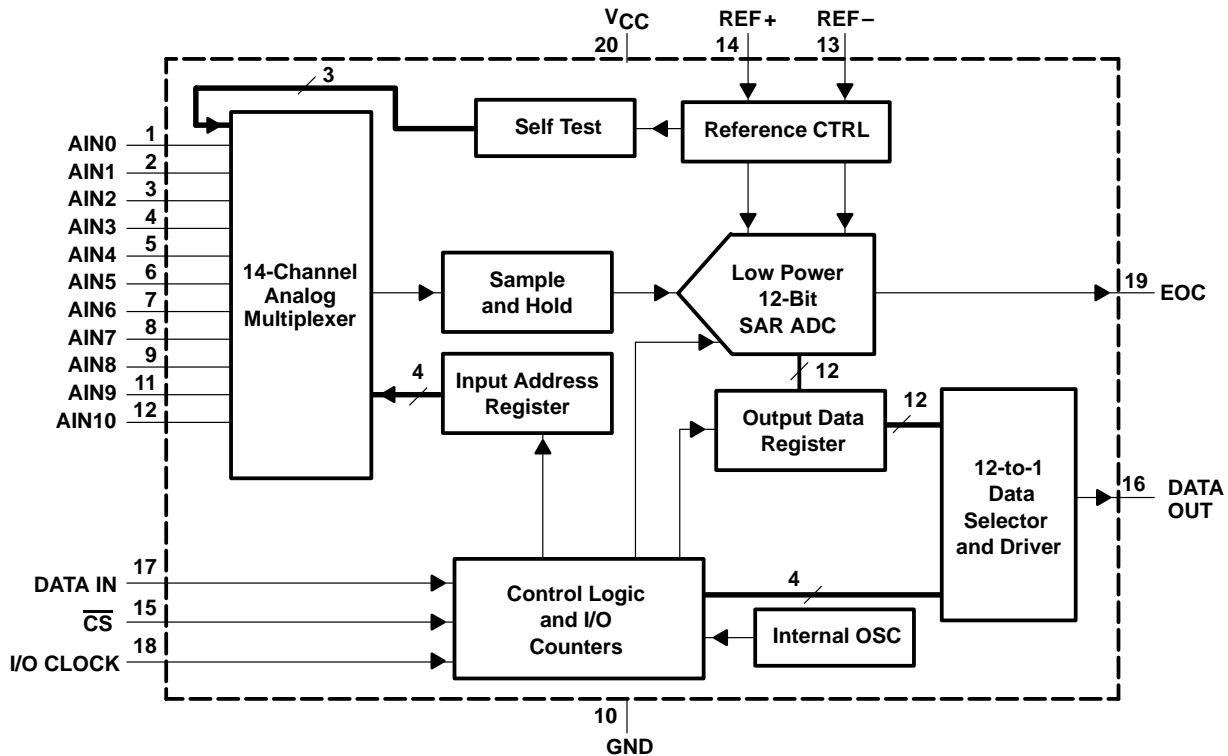

## Terminal Functions

TERMINAL NAME	NO.	I/O	DESCRIPTION
AIN0 – AIN10	1–9, 11, 12	I	Analog input. These 11 analog-signal inputs are internally multiplexed.
$\overline{\text{CS}}$	15	I	Chip select. A high-to-low transition on $\overline{\text{CS}}$ resets the internal counters and controls and enables DATA OUT, DATA IN, and I/O CLOCK. A low-to-high transition disables DATA IN and I/O CLOCK within a setup time.
DATA IN	17	I	Serial data input. The 4-bit serial data can be used as address selects the desired analog input channel or test voltage to be converted next, or a command to activate other other features. The input data is presented with the MSB (D7) first and is shifted in on the first four rising edges of the I/O CLOCK. After the four address/command bits are read into the command register CMR, I/O CLOCK clocks the remaining four bits of configuration in.
DATA OUT	16	O	The 3-state serial output for the A/D conversion result. DATA OUT is in the high-impedance state when $\overline{\text{CS}}$ is high and active when $\overline{\text{CS}}$ is low. With a valid $\overline{\text{CS}}$ , DATA OUT is removed from the high-impedance state and is driven to the logic level corresponding to the MSB(most significant bit)/LSB(least significant bit) value of the previous conversion result. The next falling edge of I/O CLOCK drives DATA OUT to the logic level corresponding to the next MSB/LSB, and the remaining bits are shifted out in order.
EOC	19	O	Status output, used to indicate the end of conversion (EOC) to the host processor. EOC goes from a high to a low logic level after the falling edge of the last I/O CLOCK and remains low until the conversion is complete and the data is ready for transfer.
GND	10		Ground. GND is the ground return terminal for the internal circuitry. Unless otherwise noted, all voltage measurements are with respect to GND.
I/O CLOCK	18	I	Input/output clock. I/O CLOCK receives the serial input and performs the following four functions: 1. It clocks the eight input data bits into the input data register on the first eight rising edges of I/O CLOCK with the multiplexer address available after the fourth rising edge. 2. On the fourth falling edge of I/O CLOCK, the analog input voltage on the selected multiplexer input begins charging the capacitor array and continues to do so until the last falling edge of I/O CLOCK. 3. The remaining 11 bits of the previous conversion data are shifted out on DATA OUT. Data changes on the falling edge of I/O CLOCK. 4. Control of the conversion is transferred to the internal state controller on the falling edge of the last I/O CLOCK.
REF+	14	I/O	Positive reference voltage The upper reference voltage value (nominally $V_{\text{CC}}$ ) is applied to REF+. The maximum analog input voltage range is determined by the difference between the voltage applied to terminals REF+ and REF–.
REF–	13	I/O	Negative reference voltage. The lower reference voltage value (nominally ground) is applied to REF–. This pin is connected to analog ground (GND of the ADC) when internal reference is used.
VCC	20		Positive supply voltage

# TLV2553

SLAS354B – SEPTEMBER 2001 – REVISED SEPTEMBER 2002

## absolute maximum ratings over operating free-air temperature range (unless otherwise noted)†

Supply voltage range, $V_{CC}$ (see Note 1)	–0.5 V to 6.5 V
Input voltage range, $V_I$ (any input)	–0.3 V to $V_{CC} + 0.3$ V
Output voltage range, $V_O$	–0.3 V to $V_{CC} + 0.3$ V
Positive reference voltage, $V_{ref+}$	–0.3 V to $V_{CC} + 0.3$ V
Negative reference voltage, $V_{ref-}$	–0.3 V to $V_{CC} + 0.3$ V
Peak input current, $I_I$ (any input)	±20 mA
Peak total input current (all inputs)	±30 mA
Operating virtual junction temperature range, $T_J$	–40°C to 150°C
Operating free-air temperature range, $T_A$ : I	–40°C to 85°C
Storage temperature range, $T_{stg}$	–65°C to 150°C
Lead temperature 1,6 mm (1/16 inch) from the case for 10 seconds	260°C

† Stresses beyond those listed under “absolute maximum ratings” may cause permanent damage to the device. These are stress ratings only, and functional operation of the device at these or any other conditions beyond those indicated under “recommended operating conditions” is not implied. Exposure to absolute-maximum-rated conditions for extended periods may affect device reliability.

NOTE 1: All voltage values are with respect to the GND terminal with REF– and GND wired together (unless otherwise noted).

## recommended operating conditions

PARAMETERS		MIN	NOM	MAX	UNIT
Supply voltage, $V_{CC}$		2.7		5.5	V
I/O CLOCK frequency	$V_{CC} = 4.5$ V to 5.5 V	16-bit I/O	0.01	15	MHz
		12-bit I/O	0.01	15	
		8-bit I/O	0.01	15	
	$V_{CC} = 2.7$ V to 3.6 V	0.01	10		
Tolerable clock jitter, I/O CLOCK	$V_{CC} = 4.5$ V to 5.5 V			0.38	ns
Aperture jitter	$V_{CC} = 4.5$ V to 5.5 V		100		ps
Analog input voltage (see Note 2)	$V_{CC} = 4.5$ V to 5.5 V	0	(REF+) – (REF–)		V
	$V_{CC} = 3.0$ V to 3.6 V	0	(REF+) – (REF–)		
	$V_{CC} = 2.7$ V to 3.0 V	0	(REF+) – (REF–)		
High-level control input voltage, $V_{IH}$	$V_{CC} = 4.5$ V to 5.5 V	2.0			V
	$V_{CC} = 2.7$ V to 3.6 V	2.1			
Low-level control input voltage, $V_{IL}$	$V_{CC} = 4.5$ V to 5.5 V			0.8	V
	$V_{CC} = 2.7$ V to 3.6 V			0.6	
Operating free-air temperature, $T_A$	TLV2553I	–40		85	°C

NOTE 2: Analog input voltages greater than the voltage applied to REF+ convert as all ones (1111111111), while input voltages less than the voltage applied to REF– convert as all zeros (000000000000).

electrical characteristics over recommended operating free-air temperature range,  $V_{REF+} = 5\text{ V}$ , I/O CLOCK frequency = 15 MHz when  $V_{CC} = 5\text{ V}$ ,  $V_{REF+} = 2.5\text{ V}$ , I/O CLOCK frequency = 10 MHz when  $V_{CC} = 2.7\text{ V}$  (unless otherwise noted)

PARAMETER		TEST CONDITIONS	MIN	TYP†	MAX	UNIT
V <sub>OH</sub>	High-level output voltage	V <sub>CC</sub> = 4.5 V, I <sub>OH</sub> = -1.6 mA V <sub>CC</sub> = 2.7 V, I <sub>OH</sub> = -0.2 mA	30 pF	2.4		V
		V <sub>CC</sub> = 4.5 V, I <sub>OH</sub> = -20 μA V <sub>CC</sub> = 2.7 V, I <sub>OH</sub> = -20 μA	30 pF	V <sub>CC</sub> - 0.1		
V <sub>OL</sub>	Low-level output voltage	V <sub>CC</sub> = 5.5 V, I <sub>OL</sub> = 1.6 mA V <sub>CC</sub> = 3.6 V, I <sub>OH</sub> = 0.8 mA	30 pF		0.4	V
		V <sub>CC</sub> = 5.5 V, I <sub>OL</sub> = -20 μA V <sub>CC</sub> = 3.6 V, I <sub>OH</sub> = -20 μA	30 pF		0.1	
I <sub>OZ</sub>	High-impedance off-state output current	V <sub>O</sub> = V <sub>CC</sub> , $\overline{\text{CS}}$ at V <sub>CC</sub>		1	2.5	μA
		V <sub>O</sub> = 0 V, $\overline{\text{CS}}$ at V <sub>CC</sub>		-1	-2.5	
I <sub>CC</sub>	Operating supply current	CS at 0 V, Ext. Ref	V <sub>CC</sub> = 5 V		1.2	mA
			V <sub>CC</sub> = 2.7 V		0.9	
I <sub>CC(PD)</sub>	Power-down current	For all digital inputs, 0 ≤ V <sub>I</sub> ≤ 0.5 V or V <sub>I</sub> ≥ V <sub>CC</sub> - 0.5 V, I/O CLOCK = 0 V	Software power down	0.1	1	μA
			Auto power down	0.1	10	
I <sub>IH</sub>	High-level input current	V <sub>I</sub> = V <sub>CC</sub>		0.005	2.5	μA
I <sub>IL</sub>	Low-level input current	V <sub>I</sub> = 0 V		-0.005	-2.5	μA
I <sub>Ikg</sub>	Selected channel leakage current	Selected channel at V <sub>CC</sub> , Unselected channel at 0 V			1	μA
		Selected channel at 0 V, Unselected channel at V <sub>CC</sub>			-1	
f(OSC)	Internal oscillator frequency	V <sub>CC</sub> = 4.5 V to 5.5 V		3.27		MHz
		V <sub>CC</sub> = 2.7 V to 3.6 V		2.56		
t <sub>convert</sub>	Conversion time = 13.5X [f(OSC)] + 25 ns	V <sub>CC</sub> = 4.5 V to 5.5 V			4.15	μs
		V <sub>CC</sub> = 2.7 V to 3.6 V			5.54	
	Internal oscillator frequency voltage			3.6	4.1	V
Z <sub>i</sub>	Input impedance‡	Analog inputs	V <sub>CC</sub> = 4.5 V		500	Ω
			V <sub>CC</sub> = 2.7 V		600	
C <sub>i</sub>	Input capacitance	Analog inputs		45	55	pF
		Control inputs		5	15	

† All typical values are at V<sub>CC</sub> = 5 V, T<sub>A</sub> = 25°C.

‡ The switch resistance is very nonlinear and varies with input voltage and supply voltage. This is the worst case.

**external reference specifications**

PARAMETER	TEST CONDITIONS	MIN	TYP†	MAX	UNIT
Reference input voltage, REF-	V <sub>CC</sub> = 4.5 V to 5.5 V	-0.1	0	0.1	V
	V <sub>CC</sub> = 2.7 V to 3.6 V	-0.1	0	0.1	
Reference input voltage, REF+	V <sub>CC</sub> = 4.5 V to 5.5 V	2		V <sub>CC</sub>	V
	V <sub>CC</sub> = 2.7 V to 3.6 V	2		V <sub>CC</sub>	
External reference input voltage difference, (REF+) – (REF-)	V <sub>CC</sub> = 4.5 V to 5.5 V	1.9		V <sub>CC</sub>	V
	V <sub>CC</sub> = 2.7 V to 3.6 V	1.9		V <sub>CC</sub>	
External reference supply current	CS at 0 V	V <sub>CC</sub> = 4.5 V to 5.5 V		0.94	mA
		V <sub>CC</sub> = 2.7 V to 3.6 V		0.62	
Reference input impedance	V <sub>CC</sub> = 5 V	Static		1	MΩ
		During sampling/conversion		6	9
	V <sub>CC</sub> = 2.7 V	Static		1	MΩ
		During sampling/conversion		6	9

† All typical values are at T<sub>A</sub> = 25°C.

NOTE: Add a 0.1-μF capacitor between REF+ and REF- pins when external reference is used.

**operating characteristics over recommended operating free-air temperature range, V<sub>REF+</sub> = 5 V, I/O CLOCK frequency = 15 MHz when V<sub>CC</sub> = 5 V, V<sub>REF+</sub> = 2.5 V, I/O CLOCK frequency = 10 MHz when V<sub>CC</sub> = 2.7 V (unless otherwise noted)**

PARAMETER	TEST CONDITIONS	MIN	TYP†	MAX	UNIT
INL Integral linearity error (see Note 3)		-1		1	LSB
DNL Differential linearity error		-1		1	LSB
E <sub>O</sub> Offset error (see Note 4)	See Note 2	-2		2	mV
E <sub>G</sub> Gain error (see Note 4)	See Note 2	-3		3	mV
E <sub>T</sub> Total unadjusted error (see Note 5)			±1.5		LSB
Self-test output code (see Table 2 and Note 6)	Address data input = 1011		2048		
	Address data input = 1100		0		
	Address data input = 1101		4095		

† All typical values are at T<sub>A</sub> = 25°C.

- NOTES:
- Analog input voltages greater than the voltage applied to REF+ convert as all ones (1111111111), while input voltages less than the voltage applied to REF- convert as all zeros (0000000000).
  - Linearity error is the maximum deviation from the best straight line through the A/D transfer characteristics.
  - Gain error is the difference between the actual midstep value and the nominal midstep value in the transfer diagram at the specified gain point after the offset error has been adjusted to zero. Offset error is the difference between the actual midstep value and the nominal midstep value at the offset point.
  - Total unadjusted error comprises linearity, zero-scale, and full-scale errors.
  - Both the input address and the output codes are expressed in positive logic.

timing characteristics over recommended operating free-air temperature range,  $V_{REF+} = 5\text{ V}$ , I/O CLOCK frequency = 15 MHz,  $V_{CC} = 5\text{ V}$ , load = 25 pF (unless otherwise noted)

PARAMETER		MIN	TYP	MAX	UNIT
$t_{w1}$	Pulse duration I/O CLOCK high or low	26.7		100000	ns
$t_{su1}$	Setup time DATA IN valid before I/O CLOCK rising edge (see Figure 26)	12			ns
$t_{h1}$	Hold time DATA IN valid after I/O CLOCK rising edge (see Figure 26)	0			ns
$t_{su2}$	Setup time $\overline{CS}$ low before first rising I/O CLOCK edge (see Note 7 and Figure 27)	25			ns
$t_{h2}$	Hold time $\overline{CS}$ pulse duration high time (see Figure 27)	100			ns
$t_{h3}$	Hold time $\overline{CS}$ low after last I/O CLOCK falling edge (see Figure 27)	0			ns
$t_{h4}$	Hold time DATA OUT valid after I/O CLOCK falling edge (see Figure 28)	2			ns
$t_{h5}$	Hold time $\overline{CS}$ high after EOC rising edge when $\overline{CS}$ is toggled (see Figure 31)	0			ns
$t_{d1}$	Delay time CS falling edge to DATA OUT valid (MSB or LSB) (see Figure 25)	Load = 25 pF		28	ns
		Load = 10 pF		20	ns
$t_{d2}$	Delay time $\overline{CS}$ rising edge to DATA OUT high impedance (see Figure 25)			10	ns
$t_{d3}$	Delay time I/O CLOCK falling edge to next DATA OUT bit valid (see Figure 28)	2		20	ns
$t_{d4}$	Delay time Last I/O CLOCK falling edge to EOC falling edge			55	ns
$t_{d5}$	Delay time last I/O CLOCK falling edge to $\overline{CS}$ falling edge to abort conversion			1.5	$\mu\text{s}$
$t_{t1}$	Transition time I/O CLOCK (see Note 7 and Figure 28)			1	$\mu\text{s}$
$t_{t2}$	Transition time DATA OUT (see Figure 28)			5	ns
$t_{t3}$	Transition time $\overline{INT}/\text{EOC}$ , $C_L$ at 7 pF (see Figure 30)			2.4	ns
$t_{t4}$	Transition time DATA IN, $\overline{CS}$			10	$\mu\text{s}$
$t_{\text{cycle}}$	Total cycle time (sample, conversion and delays) (see Note 7)			$\text{MAX}(t_{\text{convert}}) +$ I/O period (8/12/16 CLKs)	$\mu\text{s}$
$t_{\text{sample}}$	Channel acquisition time (sample), at 1 k $\Omega$ See Figures 33–38 and Note 7	Source impedance = 25 $\Omega$	600		ns
		Source impedance = 100 $\Omega$	650		
		Source impedance = 500 $\Omega$	700		
		Source impedance = 1 k $\Omega$	1000		

NOTE 7: I/O CLOCK period = 8X [1/(I/O CLOCK frequency)] or 12X [1/(I/O CLOCK frequency)] or 16X [1/(I/O CLOCK frequency)] depends on I/O format selected.

# TLV2553

SLAS354B – SEPTEMBER 2001 – REVISED SEPTEMBER 2002

**timing characteristics over recommended operating free-air temperature range,  $V_{REF+} = 2.5 V$ , I/O CLOCK frequency = 10 MHz,  $V_{CC} = 2.7 V$ , load = 25 pF (unless otherwise noted)**

PARAMETER		MIN	TYP	MAX	UNIT
$t_{w1}$	Pulse duration I/O CLOCK high or low	40		100000	ns
$t_{su1}$	Setup time DATA IN valid before I/O CLOCK rising edge (see Figure 26)	22			ns
$t_{h1}$	Hold time DATA IN valid after I/O CLOCK rising edge (see Figure 26)	0			ns
$t_{su2}$	Setup time $\overline{CS}$ low before first rising I/O CLOCK edge (see Note 7 and Figure 27)	33			ns
$t_{h2}$	Hold time $\overline{CS}$ pulse duration high time (see Figure 27)	100			ns
$t_{h3}$	Hold time $\overline{CS}$ low after last I/O CLOCK falling edge (see Figure 27)	0			ns
$t_{h4}$	Hold time DATA OUT valid after I/O CLOCK falling edge (see Figure 28)	2			ns
$t_{h5}$	Hold time $\overline{CS}$ high after EOC rising edge when $\overline{CS}$ is toggled (see Figure 31)	0			ns
$t_{d1}$	Delay time CS falling edge to DATA OUT valid (MSB or LSB) (see Figure 25)	Load = 25 pF		30	ns
		Load = 10 pF		22	ns
$t_{d2}$	Delay time $\overline{CS}$ rising edge to DATA OUT high impedance (see Figure 25)			10	ns
$t_{d3}$	Delay time I/O CLOCK falling edge to next DATA OUT bit valid (see Figure 28)	2		33	ns
$t_{d4}$	Delay time Last I/O CLOCK falling edge to EOC falling edge			75	ns
$t_{d5}$	Delay time last I/O CLOCK falling edge to $\overline{CS}$ falling edge to abort conversion			1.5	$\mu s$
$t_{t1}$	Transition time I/O CLOCK (see Note 7 and Figure 28)			1	$\mu s$
$t_{t2}$	Transition time DATA OUT (see Figure 28)			5	ns
$t_{t3}$	Transition time $\overline{INT}/EOC$ , $C_L$ at 7 pF (see Figure 30)			4	ns
$t_{t4}$	Transition time DATA IN, $\overline{CS}$			10	$\mu s$
$t_{cycle}$	Total cycle time (sample, conversion and delays) (see Note 7)			$MAX(t_{convert}) +$ I/O period (8/12/16 CLKs)	$\mu s$
$t_{sample}$	Channel acquisition time (sample), at 1 k $\Omega$ See Figures 33–38 and Note 7	Source impedance = 25 $\Omega$	800		ns
		Source impedance = 100 $\Omega$	850		
		Source impedance = 500 $\Omega$	1000		
		Source impedance = 1 k $\Omega$	1600		

NOTE 7: I/O CLOCK period = 8X [1/(I/O CLOCK frequency)] or 12X [1/(I/O CLOCK frequency)] or 16X [1/(I/O CLOCK frequency)] depends on I/O format selected.



TYPICAL CHARACTERISTICS

SUPPLY CURRENT  
vs  
FREE-AIR TEMPERATURE

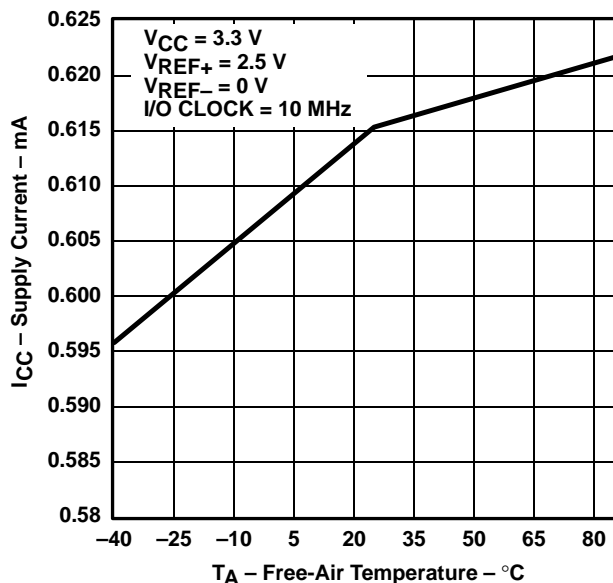

Figure 1

EXTERNAL REFERENCE CURRENT  
vs  
FREE-AIR TEMPERATURE

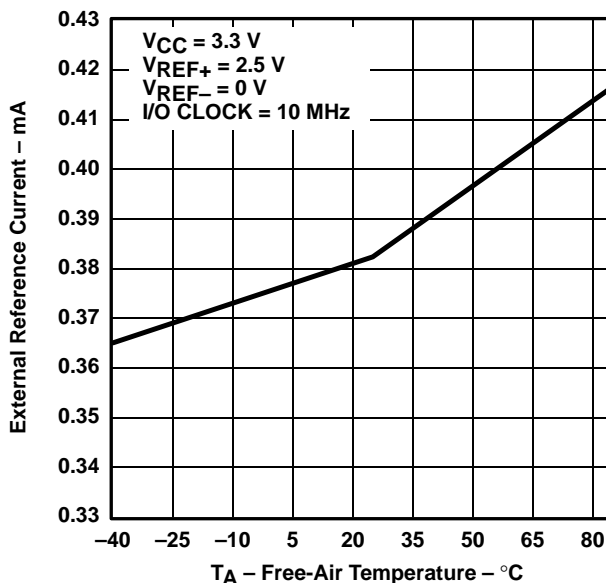

Figure 2

SOFTWARE POWER DOWN  
vs  
FREE-AIR TEMPERATURE

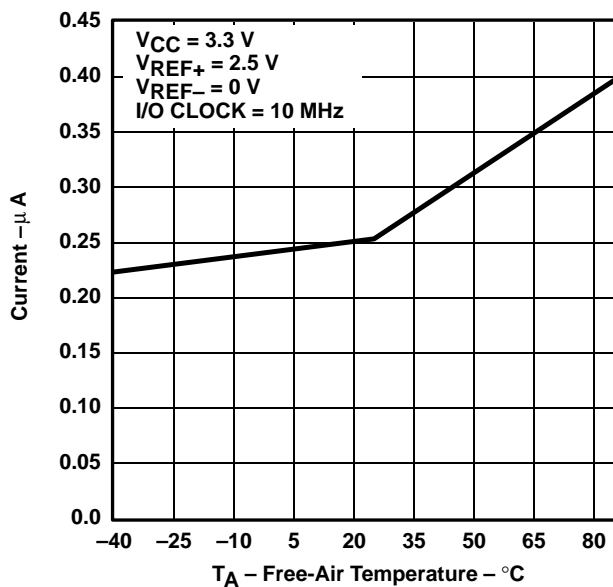

Figure 3

AUTO POWER DOWN  
vs  
FREE-AIR TEMPERATURE

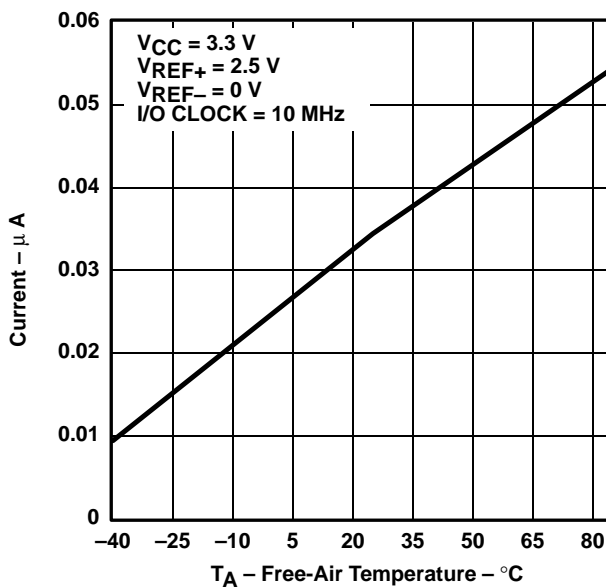

Figure 4

TYPICAL CHARACTERISTICS

MAXIMUM DIFFERENTIAL NONLINEARITY  
vs  
FREE-AIR TEMPERATURE

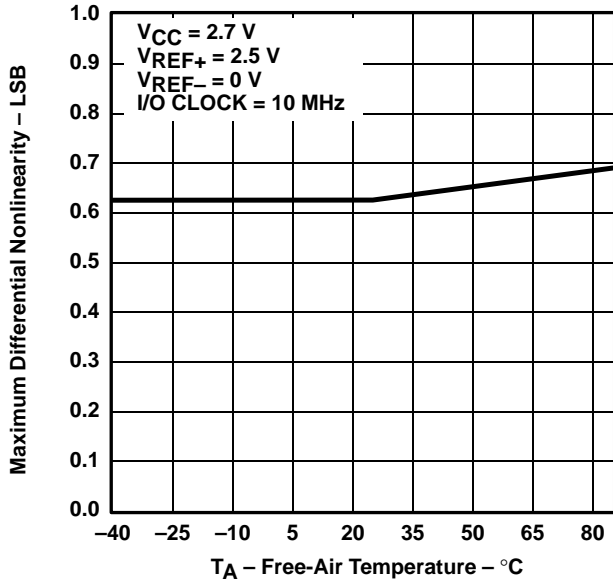

Figure 5

MINIMUM DIFFERENTIAL NONLINEARITY  
vs  
FREE-AIR TEMPERATURE

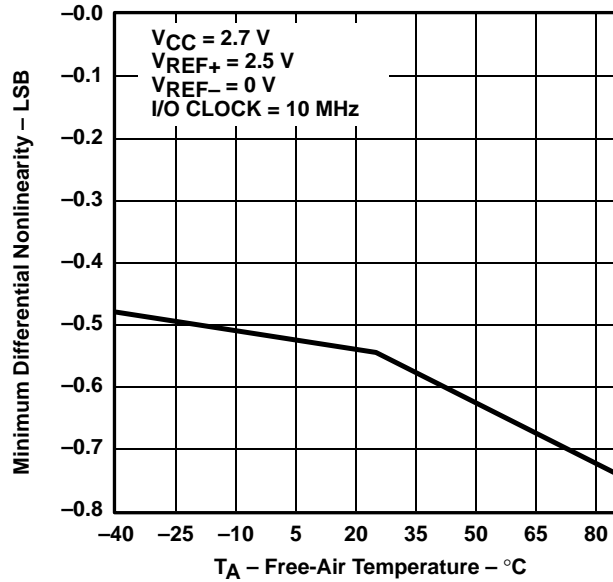

Figure 6

MAXIMUM INTEGRAL NONLINEARITY  
vs  
FREE-AIR TEMPERATURE

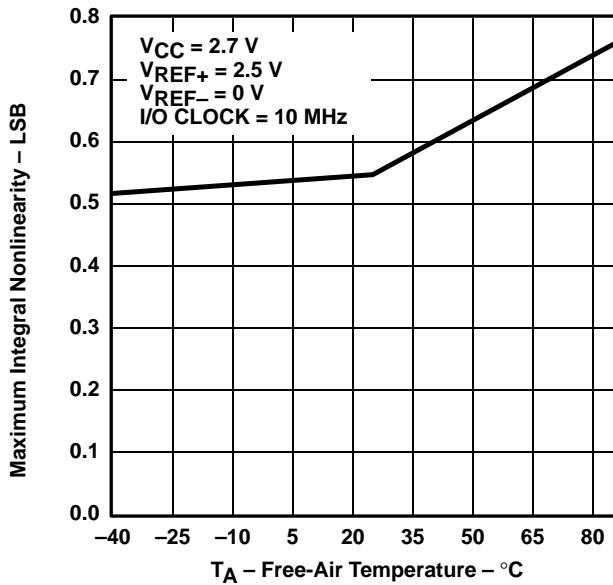

Figure 7

MINIMUM INTEGRAL NONLINEARITY  
vs  
FREE-AIR TEMPERATURE

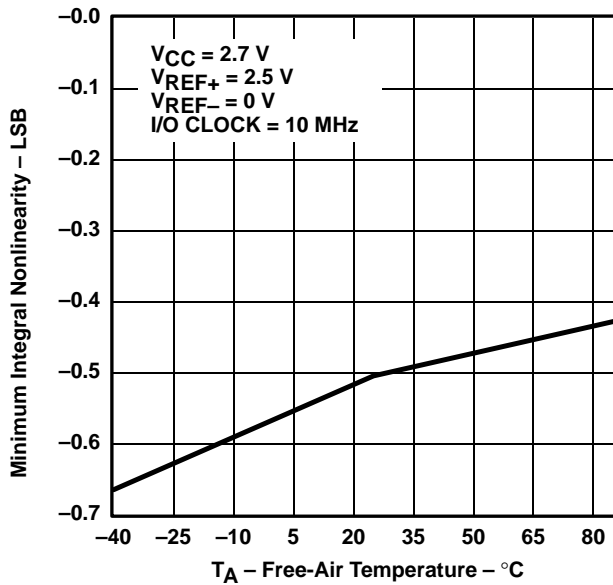

Figure 8

TYPICAL CHARACTERISTICS

DIFFERENTIAL NONLINEARITY  
vs  
DIGITAL OUTPUT CODE

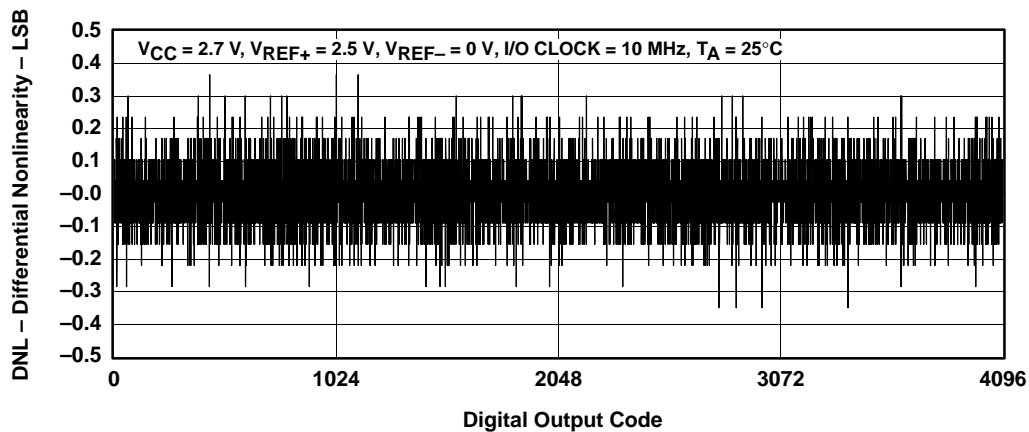

Figure 9

INTEGRAL NONLINEARITY  
vs  
DIGITAL OUTPUT CODE

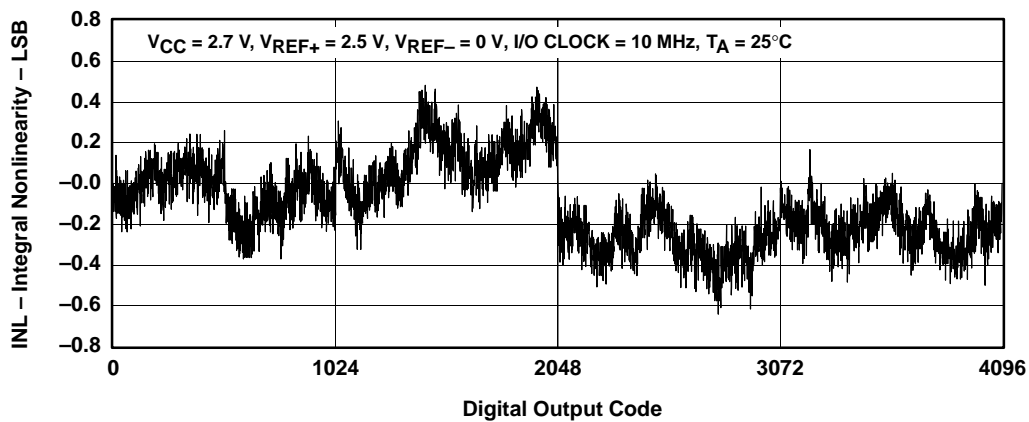

Figure 10

TYPICAL CHARACTERISTICS

OFFSET ERROR  
vs  
FREE-AIR TEMPERATURE

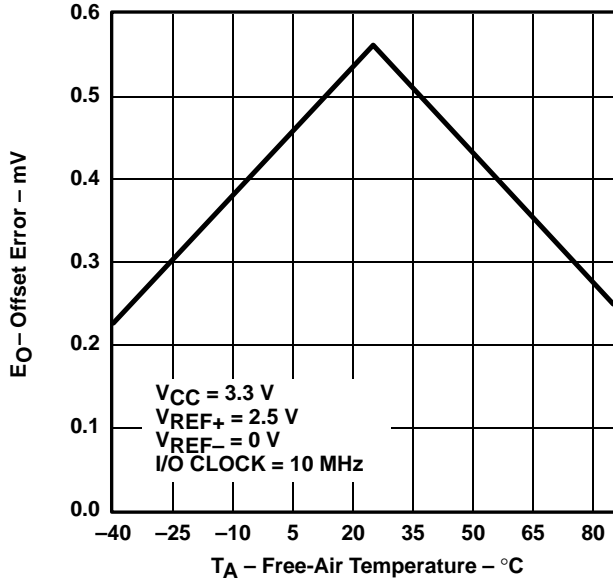

Figure 11

GAIN ERROR  
vs  
FREE-AIR TEMPERATURE

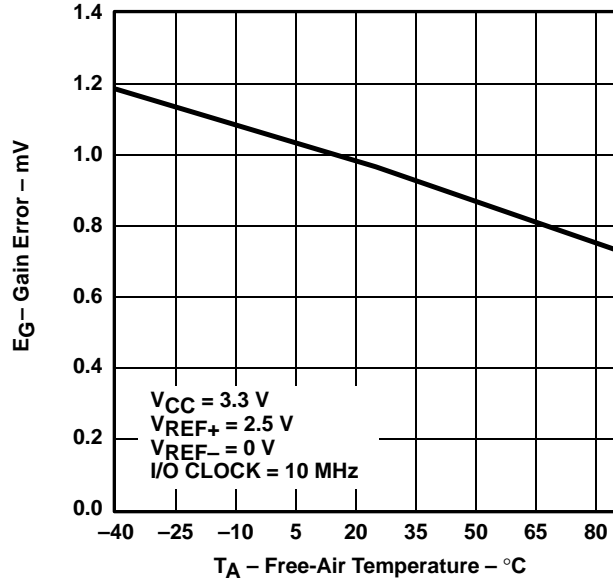

Figure 12

SUPPLY CURRENT  
vs  
FREE-AIR TEMPERATURE

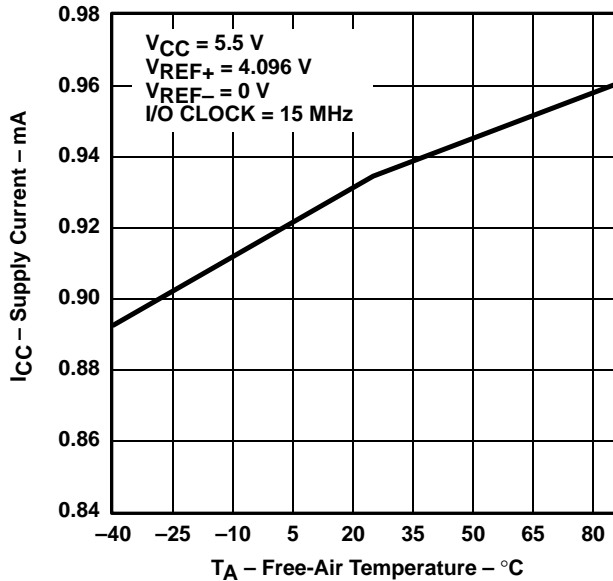

Figure 13

EXTERNAL REFERENCE CURRENT  
vs  
FREE-AIR TEMPERATURE

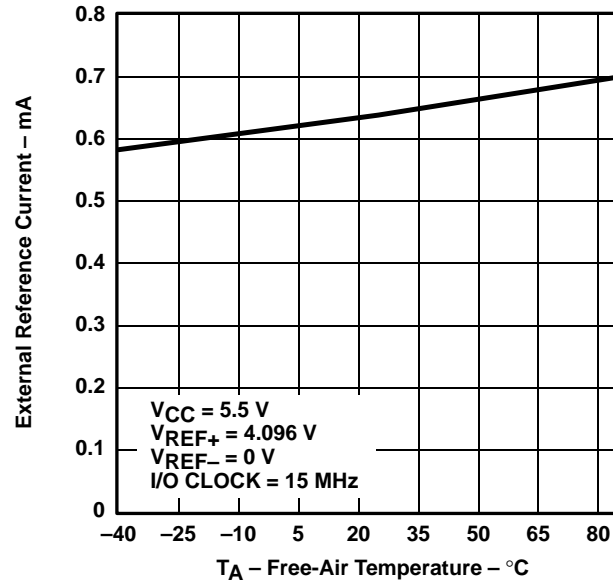

Figure 14

TYPICAL CHARACTERISTICS

SOFTWARE POWER DOWN  
vs  
FREE-AIR TEMPERATURE

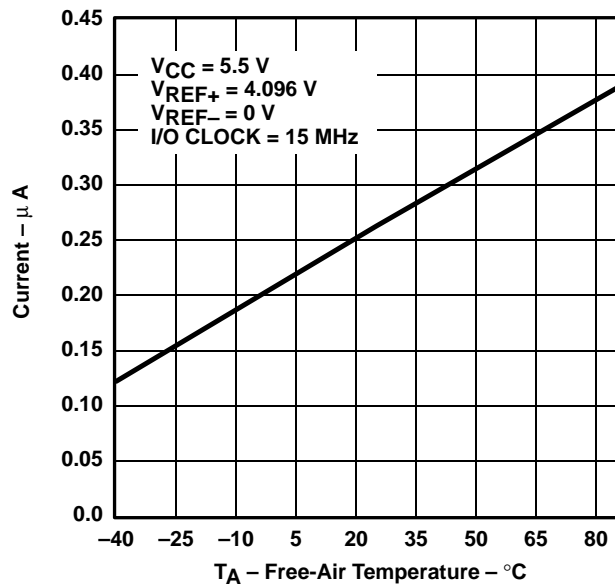

Figure 15

AUTO POWER DOWN  
vs  
FREE-AIR TEMPERATURE

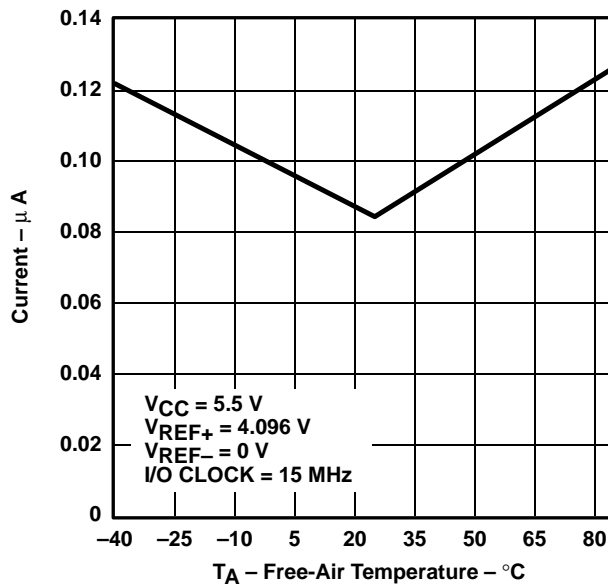

Figure 16

MAXIMUM DIFFERENTIAL NONLINEARITY  
vs  
FREE-AIR TEMPERATURE

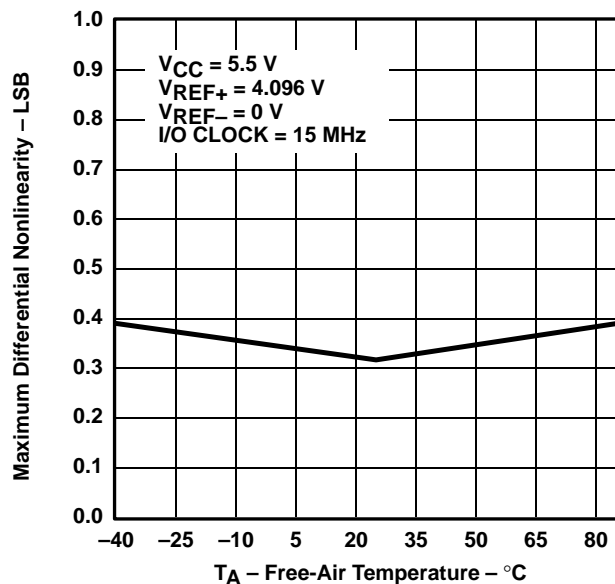

Figure 17

MINIMUM DIFFERENTIAL NONLINEARITY  
vs  
FREE-AIR TEMPERATURE

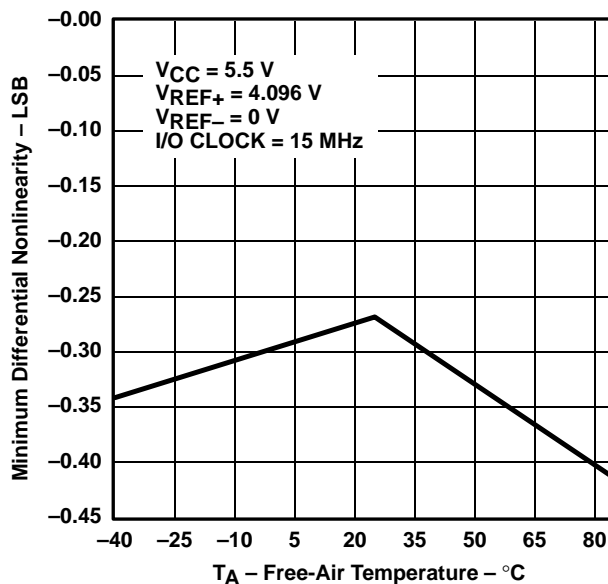

Figure 18

TYPICAL CHARACTERISTICS

MAXIMUM INTEGRAL NONLINEARITY  
vs  
FREE-AIR TEMPERATURE

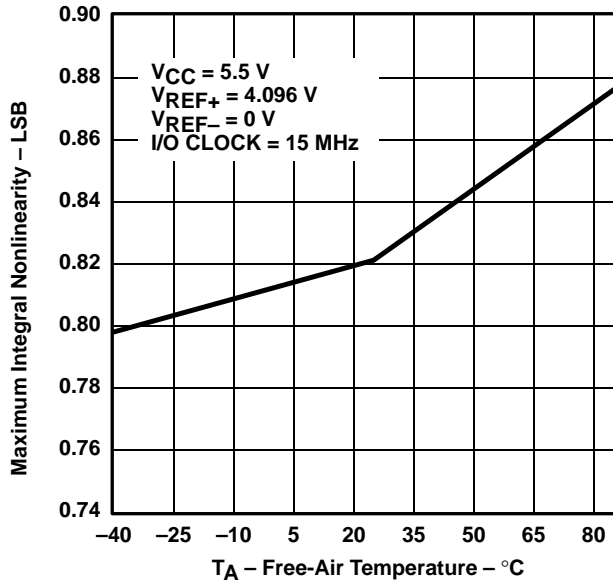

Figure 19

MINIMUM INTEGRAL NONLINEARITY  
vs  
FREE-AIR TEMPERATURE

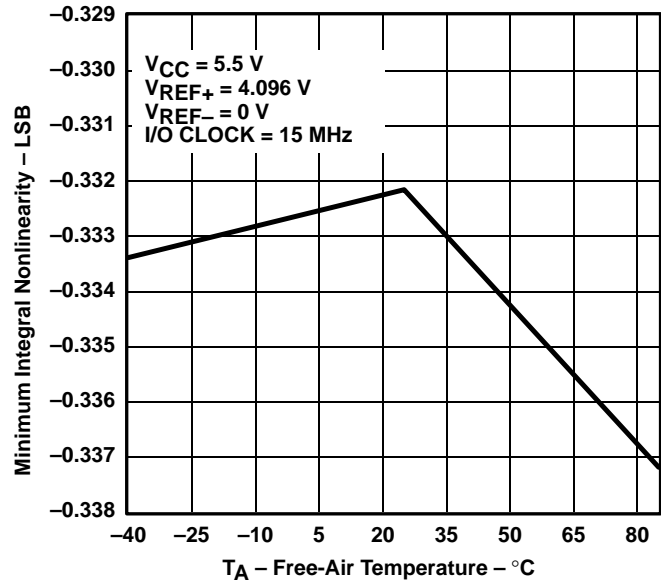

Figure 20

DIFFERENTIAL NONLINEARITY  
vs  
DIGITAL OUTPUT CODE

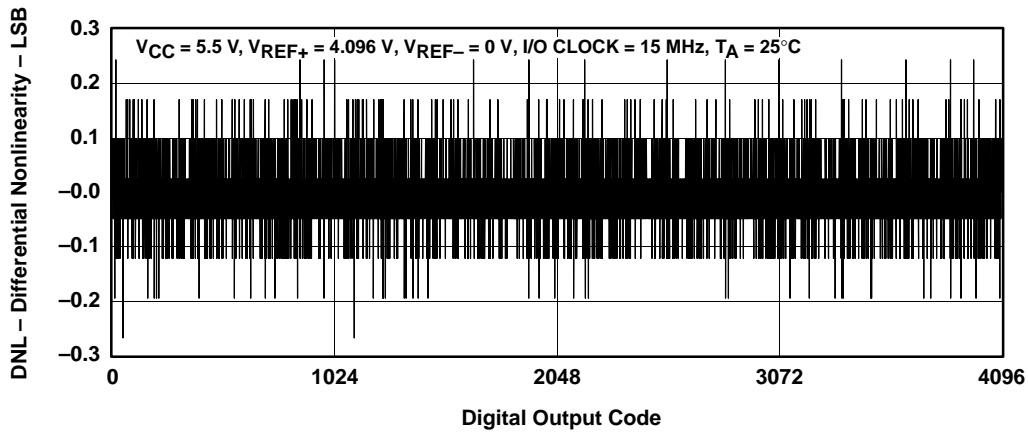

Figure 21

TYPICAL CHARACTERISTICS

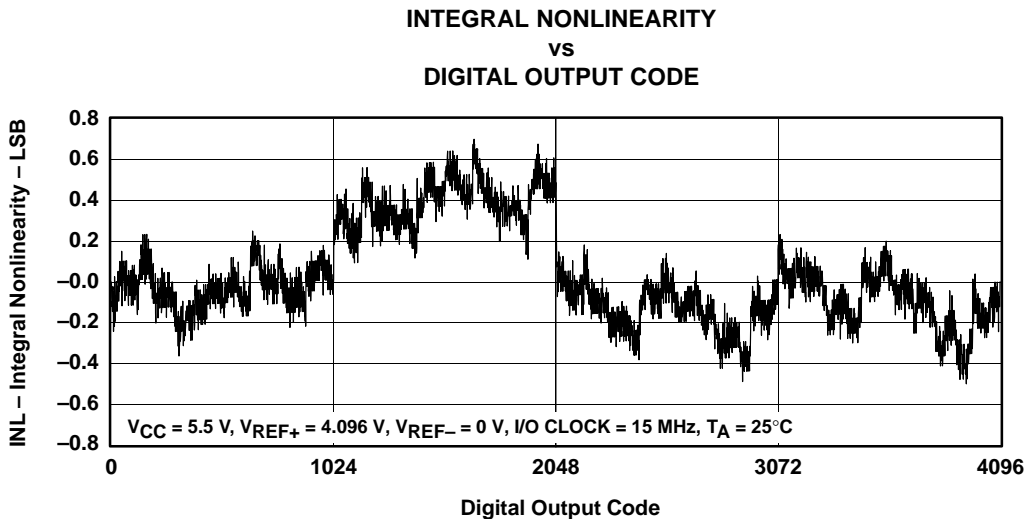

Figure 22

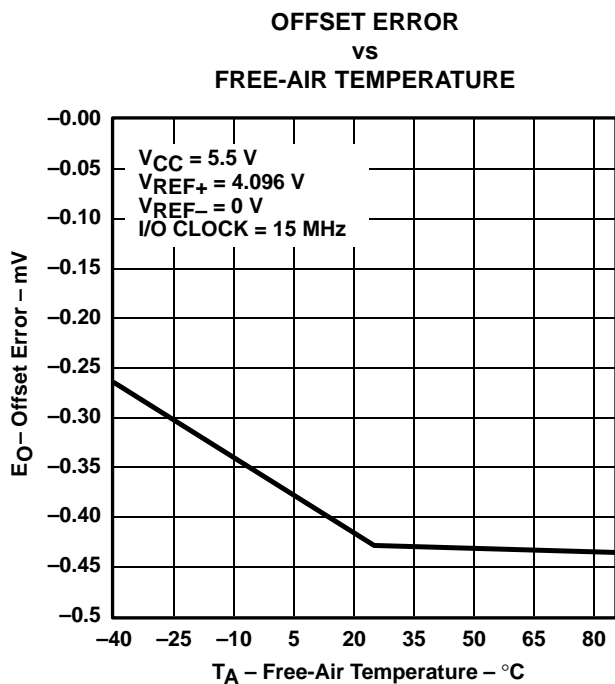

Figure 23

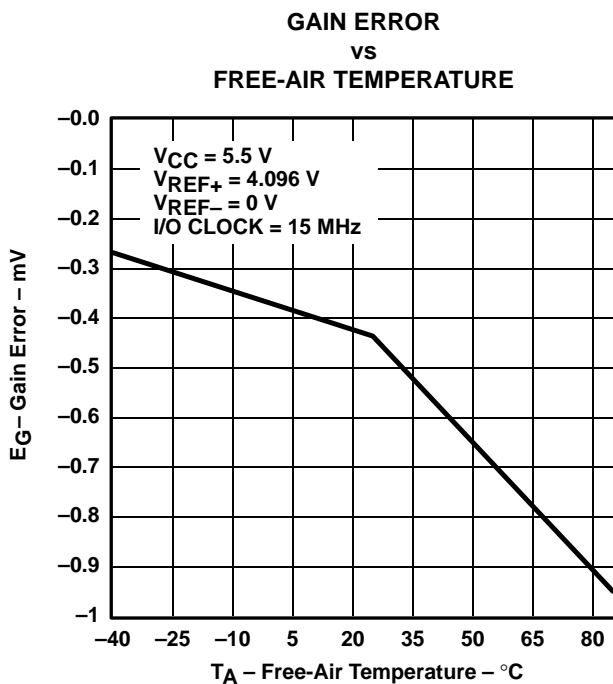

Figure 24

PARAMETER MEASUREMENT INFORMATION

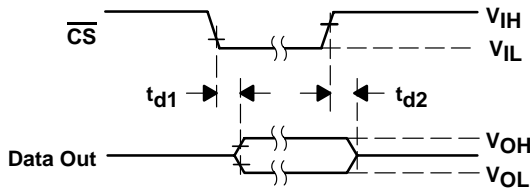

Figure 25. DATA OUT to Hi-Z Voltage Waveforms

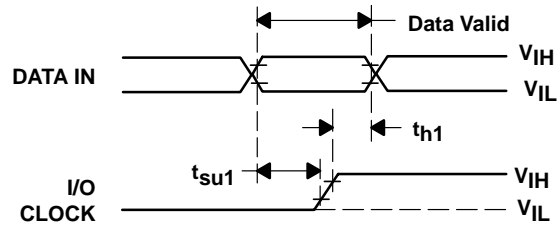

Figure 26. DATA IN and I/O CLOCK Voltage

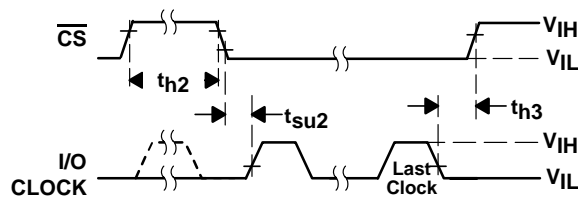

Figure 27.  $\overline{\text{CS}}$  and I/O CLOCK Voltage Waveforms

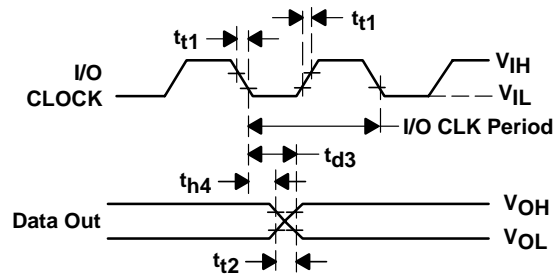

Figure 28. I/O CLOCK and DATA OUT Voltage Waveforms

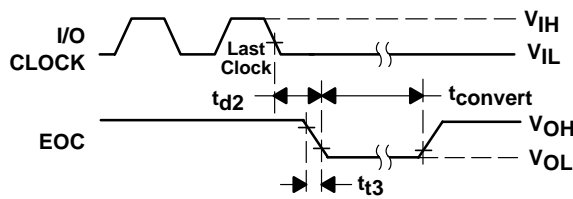

Figure 29. I/O CLOCK and EOC Voltage Waveforms

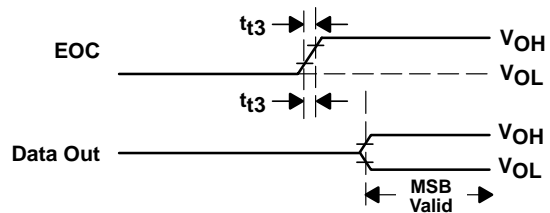

Figure 30. EOC and DATA OUT Voltage Waveforms

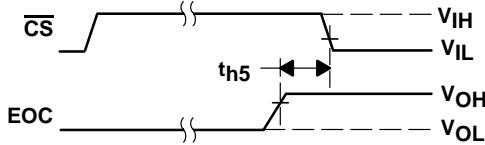

Figure 31.  $\overline{\text{CS}}$  and EOC Waveforms

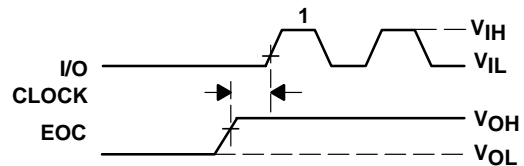

Figure 32. I/O CLOCK and DATA OUT Voltage



PARAMETER MEASUREMENT INFORMATION

timing diagrams

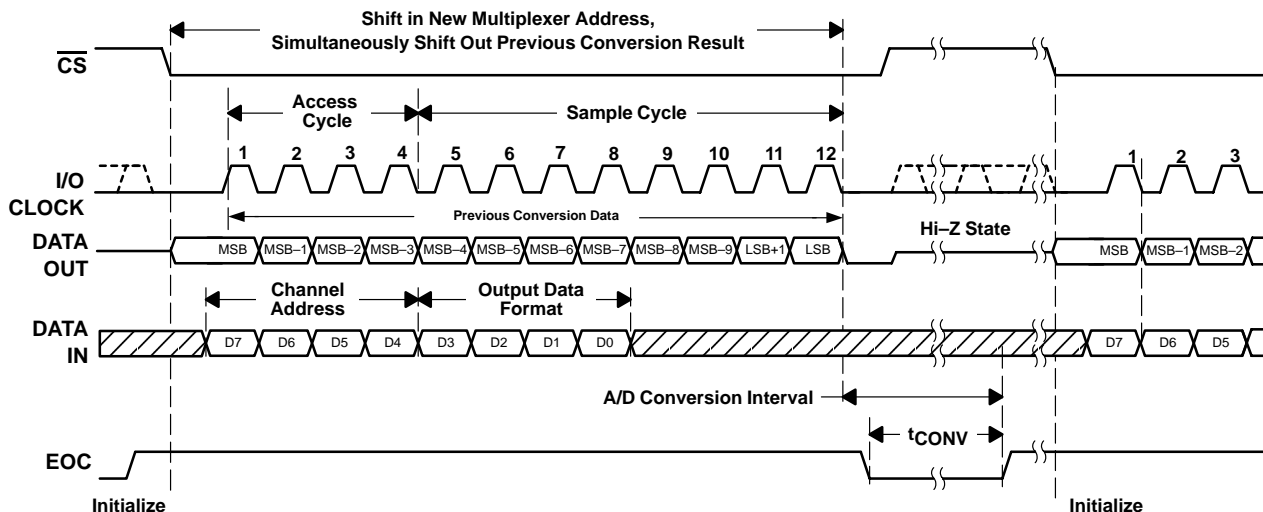

Figure 33. Timing for 12-Clock Transfer Using  $\overline{CS}$  With DATA OUT Set for MSB First

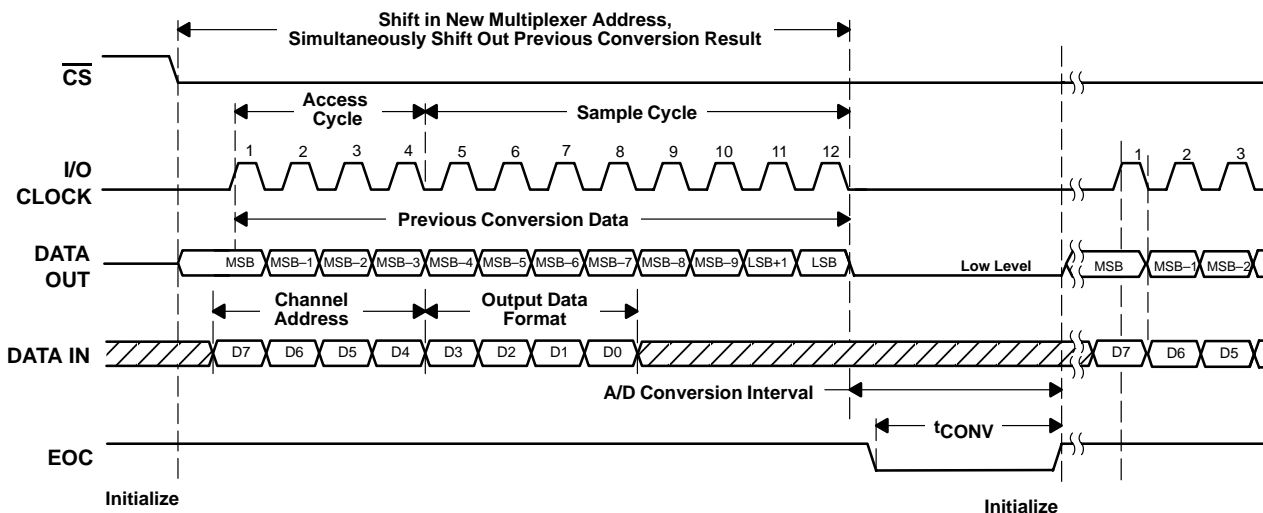

Figure 34. Timing for 12-Clock Transfer Not Using  $\overline{CS}$  With DATA OUT Set for MSB First

NOTE A: To minimize errors caused by noise at  $\overline{CS}$ , the internal circuitry waits for a setup time after the  $\overline{CS}$  falling edge before responding to control input signals. Therefore, no attempt should be made to clock in an address until the minimum  $\overline{CS}$  setup time has elapsed.

PARAMETER MEASUREMENT INFORMATION

timing diagrams (continued)

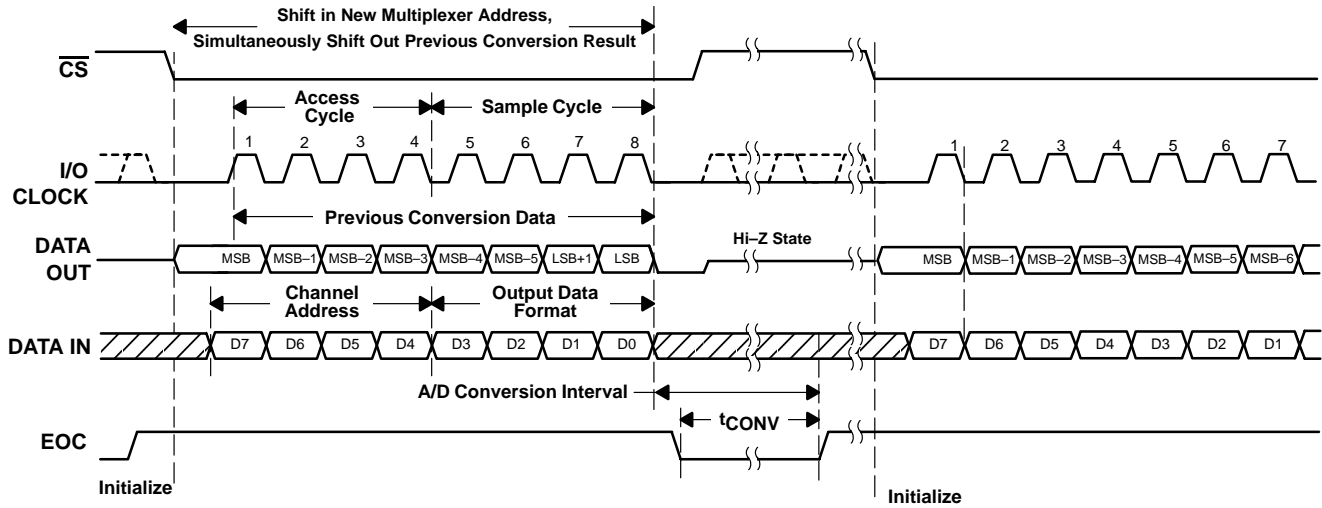

Figure 35. Timing for 8-Clock Transfer Using  $\overline{CS}$  With DATA OUT Set for MSB First

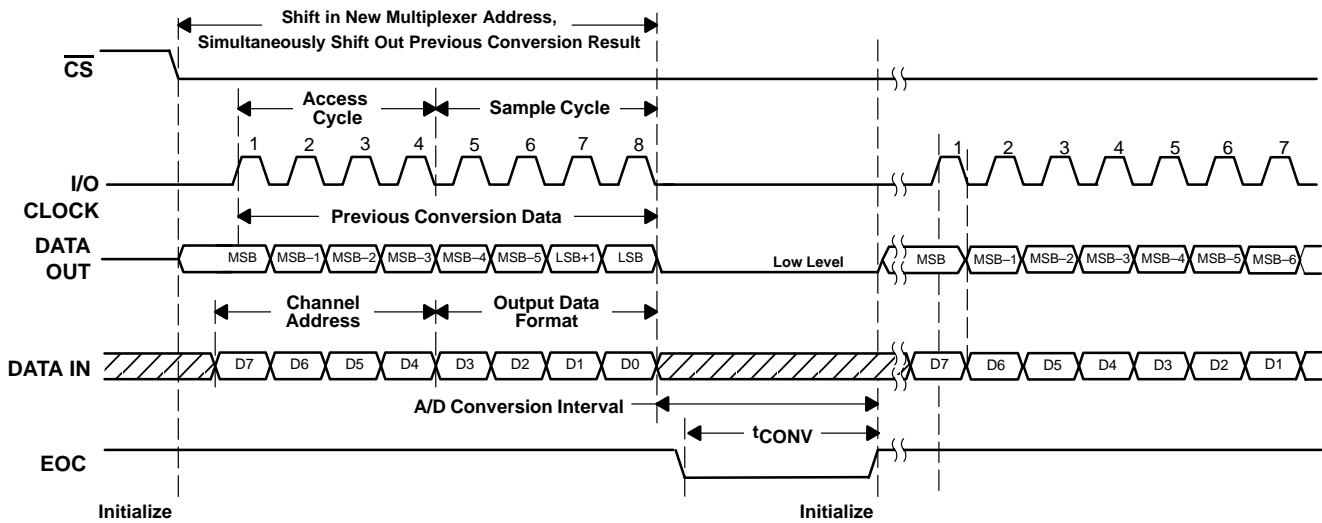

Figure 36. Timing for 8-Clock Transfer Not Using  $\overline{CS}$  With DATA OUT Set for MSB First

NOTE A: To minimize errors caused by noise at  $\overline{CS}$ , the internal circuitry waits for a setup time after the  $\overline{CS}$  falling edge before responding to control input signals. Therefore, no attempt should be made to clock in an address until the minimum  $\overline{CS}$  setup time has elapsed.

PARAMETER MEASUREMENT INFORMATION

timing diagrams (continued)

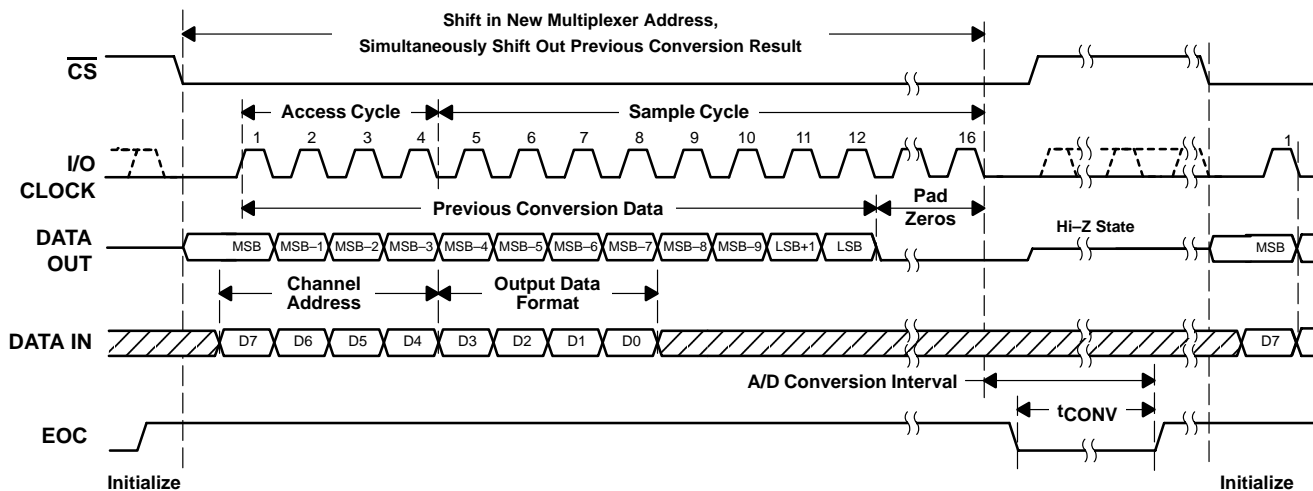

Figure 37. Timing for 16-Clock Transfer Using  $\overline{CS}$  With DATA OUT Set for MSB First

NOTE A: To minimize errors caused by noise at  $\overline{CS}$ , the internal circuitry waits for a setup time after the  $\overline{CS}$  falling edge before responding to control input signals. Therefore, no attempt should be made to clock in an address until the minimum  $\overline{CS}$  setup time has elapsed.

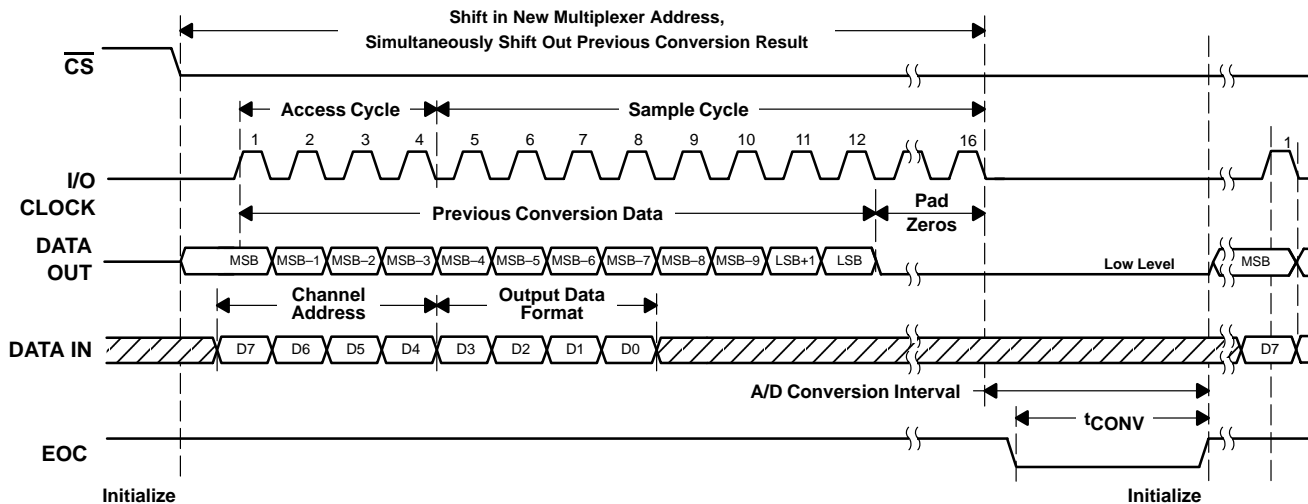

Figure 38. Timing for 16-Clock Transfer Not Using  $\overline{CS}$  With DATA OUT Set for MSB First

## PRINCIPLES OF OPERATION

### detailed description

Initially, with chip select ( $\overline{CS}$ ) high, I/O CLOCK and DATA IN are disabled and DATA OUT is in the high-impedance state.  $\overline{CS}$  going low begins the conversion sequence by enabling I/O CLOCK and DATA IN and removes DATA OUT from the high-impedance state. The input data is an 8-bit data stream consisting of a 4-bit address or command (D7–D4) and a 4-bit configuration data (D3–D0). Configuration register 1, CFGR1, which controls output data format configuration, consists of a 2-bit data length select (D3–D2), an output MSB or LSB first bit (D1), and a unipolar or bipolar output select bit (D0) that are applied to any command (from DATA IN) except for command 1111b. The I/O CLOCK sequence applied to the I/O CLOCK terminal transfers this data to the input data register. During this transfer, the I/O CLOCK sequence also shifts the previous conversion result from the output data register to DATA OUT. I/O CLOCK receives the input sequence of 8, 12, or 16 clock cycles long depending on the data-length selection in the input data register. Sampling of the analog input begins on the fourth falling edge of the input I/O CLOCK sequence and is held after the last falling edge of the I/O CLOCK sequence. The last falling edge of the I/O CLOCK sequence also takes EOC low and begins the conversion.

### converter operation

The operation of the converter is organized as a succession of three distinct cycles: 1) the data I/O cycle, 2) the sampling cycle and 3) the conversion cycle. The first two are partially overlapped.

### data I/O cycle

The data I/O cycle is defined by the externally provided I/O CLOCK and lasts 8, 12, or 16 clock periods, depending on the selected output data length. During the I/O cycle, the following two operations take place simultaneously. An 8-bit data stream consisting of address/command and configuration information is provided to DATA IN. This data is shifted into the device on the rising edge of the first eight I/O CLOCK clocks. DATA INPUT is ignored after the first eight clocks during 12- or 16-clock I/O transfers. The data output, with a length of 8, 12, or 16 bits, is provided serially on DATA OUT. When  $\overline{CS}$  is held low, the first output data bit occurs on the rising edge of EOC. When  $\overline{CS}$  is toggled between conversions, the first output data bit occurs on the falling edge of  $\overline{CS}$ . This data is the result of the previous conversion period, and after the first output data bit, each succeeding bit is clocked out on the falling edge of each succeeding I/O CLOCK.

### sampling cycle

During the sampling cycle, one of the analog inputs is internally connected to the capacitor array of the converter to store the analog input signal. The converter starts sampling the selected input immediately after the four address/command bits have been clocked into the input data register. Sampling starts on the fourth falling edge of I/O CLOCK. The converter remains in the sampling mode until the eighth, twelfth, or sixteenth falling edge of the I/O CLOCK depending on the data-length selection.

After the 8-bit data stream has been clocked in, DATA IN should be held at a fixed digital level until EOC goes high (indicating that the conversion is complete) to maximize the sampling accuracy and minimize the influence of external digital noise.

## PRINCIPLES OF OPERATION

### conversion cycle

A conversion cycle is started only after the I/O cycle is completed, which minimizes the influence of external digital noise on the accuracy of the conversion. This cycle is transparent to the user because it is controlled by an internal clock (oscillator). The total conversion time is equal to 13.5 OSC clocks plus a small delay (~25 ns) to start the OSC. During the conversion period, the device performs a successive-approximation conversion on the analog input voltage.

EOC goes low at the start of the conversion cycle and goes high when the conversion is complete and the output data register is latched. After EOC goes low, the analog input can be changed without affecting the conversion result. Since the delay from the falling edge of the last I/O CLOCK to the falling edge of EOC is fixed, any time-varying analog input signals can be digitized at a fixed rate without introducing systematic harmonic distortion or noise due to timing uncertainty.

### power up and initialization

After power up,  $\overline{CS}$  must be taken from high to low to begin an I/O cycle. The EOC pin is initially high, and the configuration register is set to all zeroes. The contents of the output data register are random, and the first conversion result should be ignored. To initialize during operation,  $\overline{CS}$  is taken high and is then returned low to begin the next I/O cycle. The first conversion after the device has returned from the power-down state may not read accurately due to internal device settling.

**Table 1. Operational Terminology**

Current (N) I/O cycle	The entire I/O CLOCK sequence that transfers address and control data into the data register and clocks the digital result from the previous conversion from DATA OUT
Current (N) conversion cycle	The conversion cycle starts immediately after the current I/O cycle. The end of the current I/O cycle is the last clock falling edge in the I/O CLOCK sequence. The current conversion result is loaded into the output register when conversion is complete.
Current (N) conversion result	The current conversion result is serially shifted out on the next I/O cycle.
Previous (N-1) conversion cycle	The conversion cycle just prior to the current I/O cycle
Next (N+1) I/O cycle	The I/O period that follows the current conversion cycle

### Example:

In 12-bit mode, the result of the current conversion cycle is a 12-bit serial-data stream clocked out during the next I/O cycle. The current I/O cycle must be exactly 12 bits long to maintain synchronization, even when this corrupts the output data from the previous conversion. The current conversion is begun immediately after the twelfth falling edge of the current I/O cycle.

### data input

The data input is internally connected to an 8-bit serial-input address and control register. The register defines the operation of the converter and the output data length. The host provides the input data byte with the MSB first. Each data bit is clocked in on the rising edge of the I/O CLOCK sequence (see Table 2 for the data input-register format).

PRINCIPLES OF OPERATION

Table 2. Command Set (CMR) and Configuration

SDI D[7:4]		COMMAND
Binary,	HEX	
0000b	0h	SELECT analog input channel 0
0001b	1h	SELECT analog input channel 1
0010b	2h	SELECT analog input channel 2
0011b	3h	SELECT analog input channel 3
0100b	4h	SELECT analog input channel 4
0101b	5h	SELECT analog input channel 5
0110b	6h	SELECT analog input channel 6
0111b	7h	SELECT analog input channel 7
1000b	8h	SELECT analog input channel 8
1001b	9h	SELECT analog input channel 9
1010b	Ah	SELECT analog input channel 10
1011b	Bh	SELECT TEST, Voltage = (VREF+ + VREF-)/2
1100b	Ch	SELECT TEST, Voltage = REFM
1101b	Dh	SELECT TEST, Voltage = REFP
1110b	Eh	SW POWERDOWN (analog + reference)
1111b	Fh	Reserved

CFGR1	
SDI D[3:0]	CONFIGURATION
D[3:2]	01: 8-bit output length X0: 12-bit output length (see Note) 11: 16-bit output length
D1	0: MSB out first 1: LSB out first
D0	0: Unipolar binary 1: Bipolar 2s complement

NOTE: Select 12-bit output mode to achieve 200 KSPS sampling rate.

data input—address/command bits

The four MSBs (D7–D4) of the input data register are the address or command. These can be used to address one of the 11 input channels, address one of three reference-test voltages, or activate software power-down mode. All address/command bits affect the current conversion, which is the conversion that immediately follows the current I/O cycle. They also have access to CFGR1 except for command 1111b, which is reserved.

data output length

CFGR1 bits (D3 and D2) of the data register select the output data length. The data-length selection is valid for the current I/O cycle (the cycle in which the data is read). The data-length selection, being valid for the current I/O cycle, allows device start-up without losing I/O synchronization. A data length of 8, 12, or 16 bits can be selected. Since the converter has 12-bit resolution, a data length of 12 bits is suggested.

With D3 and D2 set to 00 or 10, the device is in the 12-bit data-length mode and the result of the current conversion is output as a 12-bit serial data stream during the next I/O cycle. The current I/O cycle must be exactly 12 bits long for proper synchronization, even when this means corrupting the output data from a previous conversion. The current conversion is started immediately after the twelfth falling edge of the current I/O cycle.

With bits D3 and D2 set to 11, the 16-bit data-length mode is selected, which allows convenient communication with 16-bit serial interfaces. In the 16-bit mode, the result of the current conversion is output as a 16-bit serial data stream during the next I/O cycle with the four LSBs always reset to 0 (pad bits). The current I/O cycle must be exactly 16 bits long to maintain synchronization even when this means corrupting the output data from the previous conversion. The current conversion is started immediately after the sixteenth falling edge of the current I/O cycle.

---

## PRINCIPLES OF OPERATION

### data output length (continued)

With bits D3 and D2 set to 01, the 8-bit data-length mode is selected, which allows fast communication with 8-bit serial interfaces. In the 8-bit mode, the result of the current conversion is output as an 8-bit serial data stream during the next I/O cycle. The current I/O cycle must be exactly eight bits long to maintain synchronization, even when this means corrupting the output data from the previous conversion. The four LSBs of the conversion result are truncated and discarded. The current conversion is started immediately after the eighth falling edge of the current I/O cycle.

Since the D3 and D2 register settings take effect on the I/O cycle when the data length is programmed, there can be a conflict with the previous cycle if the data-word length was changed. This may occur when the data format is selected to be least significant bit first, since at the time the data length change becomes effective (six rising edges of I/O CLOCK), the previous conversion result has already started shifting out. In actual operation, when different data lengths are required within an application and the data length is changed between two conversions, no more than one conversion result can be corrupted and only when it is shifted out in LSB-first format.

### LSB out first

D1 in the CFGR1 controls the direction of the output (binary) data transfer. When D1 is reset to 0, the conversion result is shifted out MSB first. When set to 1, the data is shifted out LSB first. Selection of MSB first or LSB first always affects the next I/O cycle and not the current I/O cycle. When changing from one data direction to another, the current I/O cycle is never disrupted.

### bipolar output format

D0 in the CFGR1 controls the binary data format used to represent the conversion result. When D0 is cleared to 0, the conversion result is represented as unipolar (unsigned binary) data. Nominally, the conversion result of an input voltage equal to or less than  $V_{REF-}$  is a code with all zeros (000 . . . 0) and the conversion result of an input voltage equal to or greater than  $V_{REF+}$  is a code of all ones (111 . . . 1). The conversion result of  $(V_{REF+} + V_{REF-})/2$  is a code of a one followed by zeros (100 ...0).

When D0 is set to 1, the conversion result is represented as bipolar (signed binary) data. Nominally, conversion of an input voltage equal to or less than  $V_{REF-}$  is a code of a one followed by zeros (100 . . . 0), and the conversion of an input voltage equal to or greater than  $V_{REF+}$  is a code of a zero followed by all ones (011 . . . 1). The conversion result of  $(V_{REF+} + V_{REF-})/2$  is a code of all zeros (000 . . . 0). The MSB is interpreted as the sign bit. The bipolar data format is related to the unipolar format in that the MSBs are always each other's complement.

Selection of the unipolar or bipolar format always affects the current conversion cycle, and the result is output during the next I/O cycle. When changing between unipolar and bipolar formats, the data output during the current I/O cycle is not affected.

### reference

An external reference can be used through two reference input pins, REF+ and REF-. The voltage levels applied to these pins establish the upper and lower limits of the analog inputs to produce a full-scale and zero-scale reading respectively. The values of REF+, REF-, and the analog input should not exceed the positive supply or be lower than GND consistent with the specified absolute maximum ratings. The digital output is at full scale when the input signal is equal to or higher than REF+ and at zero when the input signal is equal to or lower than REF-.

PRINCIPLES OF OPERATION

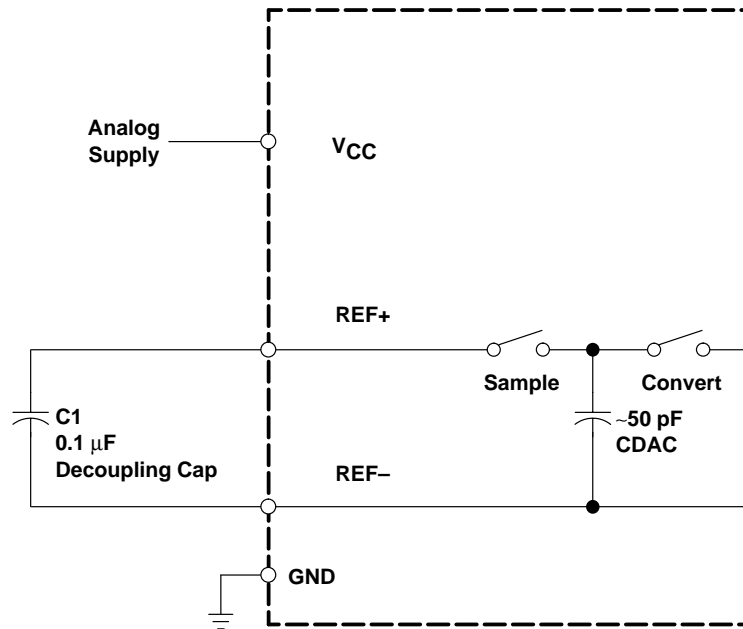

Figure 39. Reference Block

**EOC output**

Pin 19 outputs the status of the ADC conversion. When programmed as EOC, the output indicates the beginning and the end of conversion. In the reset state, EOC is always high. During the sampling period (beginning after the fourth falling edge of the I/O CLOCK sequence), EOC remains high until the internal sampling switch of the converter is safely opened. The opening of the sampling switch occurs after the eighth, twelfth, or sixteenth I/O CLOCK falling edge, depending on the data-length selection in the input data register. After the EOC signal goes low, the analog input signal can be changed without affecting the conversion result.

The EOC signal goes high again after the conversion is completed and the conversion result is latched into the output data register. The rising edge of EOC returns the converter to a reset state and a new I/O cycle begins. On the rising edge of EOC, the first bit of the current conversion result is on DATA OUT when  $\overline{CS}$  is low. When  $\overline{CS}$  is toggled between conversions, the first bit of the current conversion result occurs on DATA OUT at the falling edge of  $\overline{CS}$ .

**chip-select input ( $\overline{CS}$ )**

$\overline{CS}$  enables and disables the device. During normal operation,  $\overline{CS}$  should be low. Although the use of  $\overline{CS}$  is not necessary to synchronize a data transfer, it can be brought high between conversions to coordinate the data transfer of several devices sharing the same bus.

When  $\overline{CS}$  is brought high, the serial-data output is immediately brought to the high-impedance state, releasing its output data line to other devices that may share it. After an internally generated debounce time, I/O CLOCK is inhibited, thus preventing any further change in the internal state.

When  $\overline{CS}$  is subsequently brought low again, the device is reset.  $\overline{CS}$  must be held low for an internal debounce time before the reset operation takes effect. After  $\overline{CS}$  is debounced low, I/O CLOCK must remain inactive (low) for a minimum time before a new I/O cycle can start.



---

## PRINCIPLES OF OPERATION

### chip-select input ( $\overline{CS}$ ) (continued)

$\overline{CS}$  can interrupt any ongoing data transfer or any ongoing conversion. When  $\overline{CS}$  is debounced low long enough before the end of the current conversion cycle, the previous conversion result is saved in the internal output buffer and shifted out during the next I/O cycle.

When  $\overline{CS}$  is held low continuously for multiple cycles, the first data bit of the newly completed conversion occurs on DATA OUT on the rising edge of EOC. Note that the first cycle in the series still requires a transition  $\overline{CS}$  from high to low. When a new conversion is started after the last falling edge of I/O CLOCK, EOC goes low and the serial output is forced low until EOC goes high again.

When  $\overline{CS}$  is toggled between conversions, the first data bit occurs on DATA OUT on the falling edge of  $\overline{CS}$ . On each subsequent falling edge of I/O CLOCK after the first data bit appears, the data is changed to the next bit in the serial conversion result until the required number of bits has been output.

### power-down features

When command (D7–D4) 1110b is clocked into the input data register during the first four I/O CLOCK cycles, the software power-down mode is selected. Software power down is activated on the falling edge of the fourth I/O CLOCK pulse.

During software power-down, all internal circuitry is put in a low-current standby mode. No conversions is performed. The internal output buffer keeps the previous conversion cycle data results, provided that all digital inputs are held above  $V_{CC} - 0.5$  V or below 0.5 V. The I/O logic remains active so the current I/O cycle must be completed even when the power-down mode is selected. Upon power-on reset and before the first I/O cycle, the converter normally begins in the power-down mode. The device remains in the software power-down mode until a valid input address (other than command 1110b or 1111b) is clocked in. Upon completion of that I/O cycle, a normal conversion is performed with the results being shifted out during the next I/O cycle.

The ADC also has an auto power-down mode. This is transparent to users. The ADC gets into auto power-down within 1 I/O CLOCK cycle after the conversion is complete and resumes, with a small delay, after an active CS is sent to the ADC. The resumption is fast enough to be used between cycles

### analog MUX

The 11 analog inputs, three internal voltages, and power-down mode are selected by the input multiplexer according to the input addresses shown in Table 2. The input multiplexer is a break-before-make type to reduce input-to-input noise rejection resulting from channel switching. Sampling of the analog input starts on the falling edge of the fourth I/O CLOCK and continues for the remaining I/O CLOCK pulses. The sample is held on the falling edge of the last I/O CLOCK pulse. The three internal test inputs are applied to the multiplexer, then sampled and converted in the same manner as the external analog inputs. The first conversion after the device has returned from the power-down state may not read accurately due to internal device settling.

MECHANICAL DATA

DW (R-PDSO-G\*\*)

PLASTIC SMALL-OUTLINE PACKAGE

16 PINS SHOWN

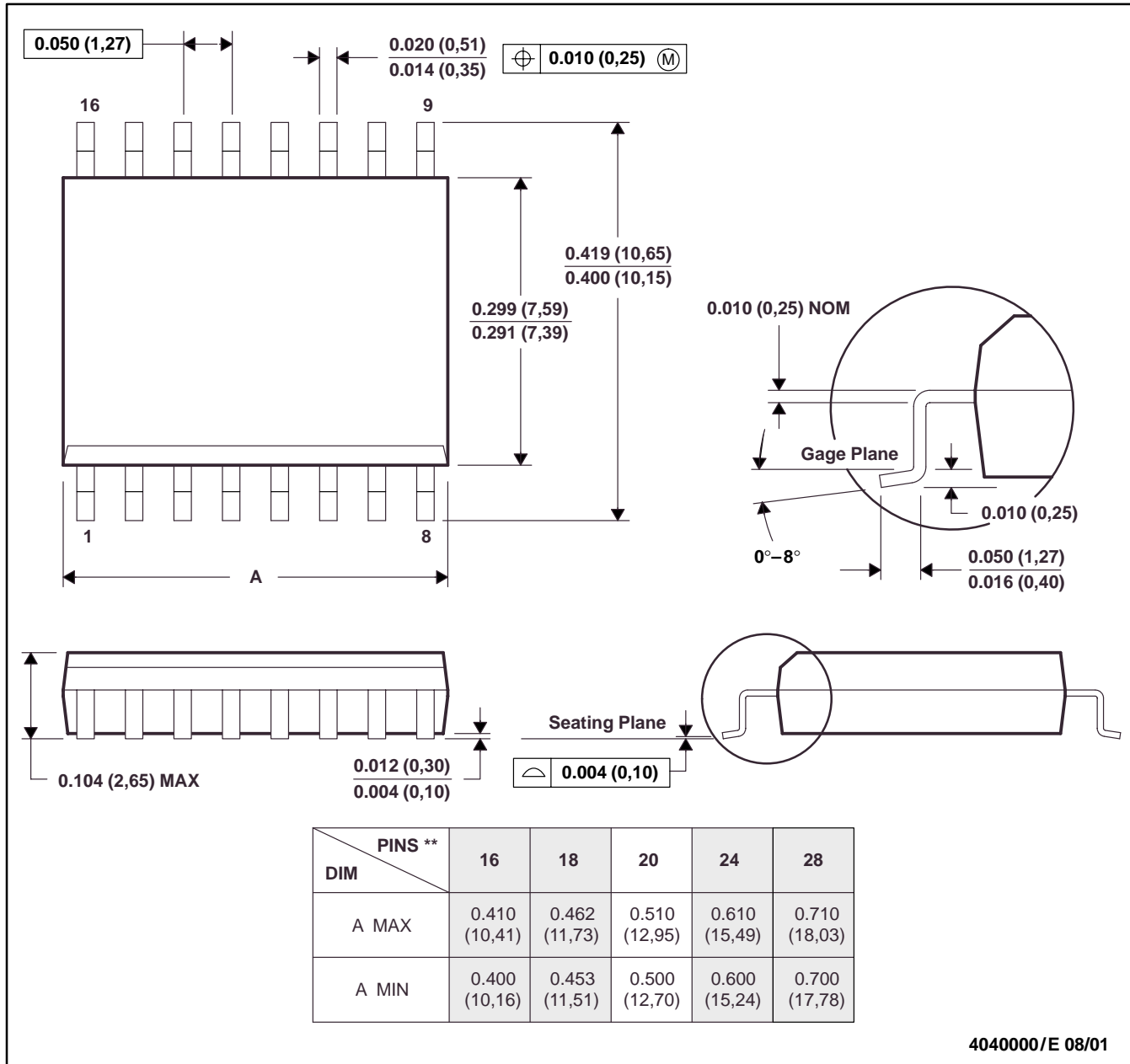

- NOTES: A. All linear dimensions are in inches (millimeters).  
 B. This drawing is subject to change without notice.  
 C. Body dimensions do not include mold flash or protrusion not to exceed 0.006 (0,15).  
 D. Falls within JEDEC MS-013

MECHANICAL DATA

PW (R-PDSO-G\*\*)

PLASTIC SMALL-OUTLINE PACKAGE

14 PINS SHOWN

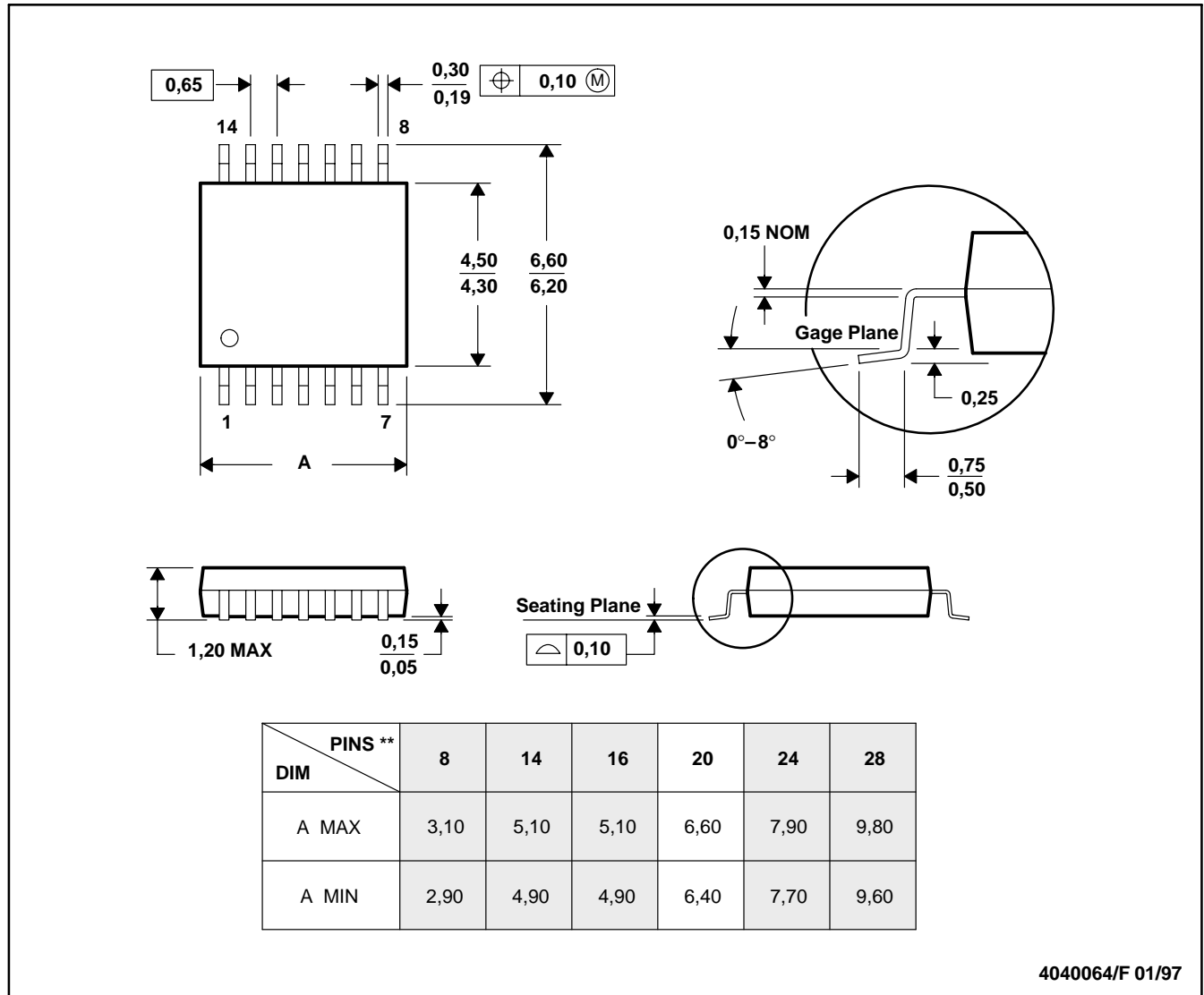

- NOTES: A. All linear dimensions are in millimeters.  
 B. This drawing is subject to change without notice.  
 C. Body dimensions do not include mold flash or protrusion not to exceed 0,15.  
 D. Falls within JEDEC MO-153

**PACKAGING INFORMATION**

Orderable Device	Status <sup>(1)</sup>	Package Type	Package Drawing	Pins	Package Qty	Eco Plan <sup>(2)</sup>	Lead/Ball Finish	MSL Peak Temp <sup>(3)</sup>
TLV2553IDW	ACTIVE	SOIC	DW	20	25	Green (RoHS & no Sb/Br)	CU NIPDAU	Level-1-260C-UNLIM
TLV2553IDWG4	ACTIVE	SOIC	DW	20	25	Green (RoHS & no Sb/Br)	CU NIPDAU	Level-1-260C-UNLIM
TLV2553IDWR	ACTIVE	SOIC	DW	20	2000	Green (RoHS & no Sb/Br)	CU NIPDAU	Level-1-260C-UNLIM
TLV2553IDWRG4	ACTIVE	SOIC	DW	20	2000	Green (RoHS & no Sb/Br)	CU NIPDAU	Level-1-260C-UNLIM
TLV2553IPW	ACTIVE	TSSOP	PW	20	70	Green (RoHS & no Sb/Br)	CU NIPDAU	Level-1-260C-UNLIM
TLV2553IPWG4	ACTIVE	TSSOP	PW	20	70	Green (RoHS & no Sb/Br)	CU NIPDAU	Level-1-260C-UNLIM
TLV2553IPWR	ACTIVE	TSSOP	PW	20	2000	Green (RoHS & no Sb/Br)	CU NIPDAU	Level-1-260C-UNLIM
TLV2553IPWRG4	ACTIVE	TSSOP	PW	20	2000	Green (RoHS & no Sb/Br)	CU NIPDAU	Level-1-260C-UNLIM

<sup>(1)</sup> The marketing status values are defined as follows:

**ACTIVE:** Product device recommended for new designs.

**LIFEBUY:** TI has announced that the device will be discontinued, and a lifetime-buy period is in effect.

**NRND:** Not recommended for new designs. Device is in production to support existing customers, but TI does not recommend using this part in a new design.

**PREVIEW:** Device has been announced but is not in production. Samples may or may not be available.

**OBSELETE:** TI has discontinued the production of the device.

<sup>(2)</sup> Eco Plan - The planned eco-friendly classification: Pb-Free (RoHS), Pb-Free (RoHS Exempt), or Green (RoHS & no Sb/Br) - please check <http://www.ti.com/productcontent> for the latest availability information and additional product content details.

**TBD:** The Pb-Free/Green conversion plan has not been defined.

**Pb-Free (RoHS):** TI's terms "Lead-Free" or "Pb-Free" mean semiconductor products that are compatible with the current RoHS requirements for all 6 substances, including the requirement that lead not exceed 0.1% by weight in homogeneous materials. Where designed to be soldered at high temperatures, TI Pb-Free products are suitable for use in specified lead-free processes.

**Pb-Free (RoHS Exempt):** This component has a RoHS exemption for either 1) lead-based flip-chip solder bumps used between the die and package, or 2) lead-based die adhesive used between the die and leadframe. The component is otherwise considered Pb-Free (RoHS compatible) as defined above.

**Green (RoHS & no Sb/Br):** TI defines "Green" to mean Pb-Free (RoHS compatible), and free of Bromine (Br) and Antimony (Sb) based flame retardants (Br or Sb do not exceed 0.1% by weight in homogeneous material)

<sup>(3)</sup> MSL, Peak Temp. -- The Moisture Sensitivity Level rating according to the JEDEC industry standard classifications, and peak solder temperature.

**Important Information and Disclaimer:**The information provided on this page represents TI's knowledge and belief as of the date that it is provided. TI bases its knowledge and belief on information provided by third parties, and makes no representation or warranty as to the accuracy of such information. Efforts are underway to better integrate information from third parties. TI has taken and continues to take reasonable steps to provide representative and accurate information but may not have conducted destructive testing or chemical analysis on incoming materials and chemicals. TI and TI suppliers consider certain information to be proprietary, and thus CAS numbers and other limited information may not be available for release.

In no event shall TI's liability arising out of such information exceed the total purchase price of the TI part(s) at issue in this document sold by TI to Customer on an annual basis.

## TAPE AND REEL INFORMATION



### QUADRANT ASSIGNMENTS FOR PIN 1 ORIENTATION IN TAPE



\*All dimensions are nominal

Device	Package Type	Package Drawing	Pins	SPQ	Reel Diameter (mm)	Reel Width W1 (mm)	A0 (mm)	B0 (mm)	K0 (mm)	P1 (mm)	W (mm)	Pin1 Quadrant
TLV2553IPWR	TSSOP	PW	20	2000	330.0	16.4	6.95	7.1	1.6	8.0	16.0	Q1

**TAPE AND REEL BOX DIMENSIONS**

\*All dimensions are nominal

Device	Package Type	Package Drawing	Pins	SPQ	Length (mm)	Width (mm)	Height (mm)
TLV2553IPWR	TSSOP	PW	20	2000	346.0	346.0	33.0

## IMPORTANT NOTICE

Texas Instruments Incorporated and its subsidiaries (TI) reserve the right to make corrections, modifications, enhancements, improvements, and other changes to its products and services at any time and to discontinue any product or service without notice. Customers should obtain the latest relevant information before placing orders and should verify that such information is current and complete. All products are sold subject to TI's terms and conditions of sale supplied at the time of order acknowledgment.

TI warrants performance of its hardware products to the specifications applicable at the time of sale in accordance with TI's standard warranty. Testing and other quality control techniques are used to the extent TI deems necessary to support this warranty. Except where mandated by government requirements, testing of all parameters of each product is not necessarily performed.

TI assumes no liability for applications assistance or customer product design. Customers are responsible for their products and applications using TI components. To minimize the risks associated with customer products and applications, customers should provide adequate design and operating safeguards.

TI does not warrant or represent that any license, either express or implied, is granted under any TI patent right, copyright, mask work right, or other TI intellectual property right relating to any combination, machine, or process in which TI products or services are used. Information published by TI regarding third-party products or services does not constitute a license from TI to use such products or services or a warranty or endorsement thereof. Use of such information may require a license from a third party under the patents or other intellectual property of the third party, or a license from TI under the patents or other intellectual property of TI.

Reproduction of TI information in TI data books or data sheets is permissible only if reproduction is without alteration and is accompanied by all associated warranties, conditions, limitations, and notices. Reproduction of this information with alteration is an unfair and deceptive business practice. TI is not responsible or liable for such altered documentation. Information of third parties may be subject to additional restrictions.

Resale of TI products or services with statements different from or beyond the parameters stated by TI for that product or service voids all express and any implied warranties for the associated TI product or service and is an unfair and deceptive business practice. TI is not responsible or liable for any such statements.

TI products are not authorized for use in safety-critical applications (such as life support) where a failure of the TI product would reasonably be expected to cause severe personal injury or death, unless officers of the parties have executed an agreement specifically governing such use. Buyers represent that they have all necessary expertise in the safety and regulatory ramifications of their applications, and acknowledge and agree that they are solely responsible for all legal, regulatory and safety-related requirements concerning their products and any use of TI products in such safety-critical applications, notwithstanding any applications-related information or support that may be provided by TI. Further, Buyers must fully indemnify TI and its representatives against any damages arising out of the use of TI products in such safety-critical applications.

TI products are neither designed nor intended for use in military/aerospace applications or environments unless the TI products are specifically designated by TI as military-grade or "enhanced plastic." Only products designated by TI as military-grade meet military specifications. Buyers acknowledge and agree that any such use of TI products which TI has not designated as military-grade is solely at the Buyer's risk, and that they are solely responsible for compliance with all legal and regulatory requirements in connection with such use.

TI products are neither designed nor intended for use in automotive applications or environments unless the specific TI products are designated by TI as compliant with ISO/TS 16949 requirements. Buyers acknowledge and agree that, if they use any non-designated products in automotive applications, TI will not be responsible for any failure to meet such requirements.

Following are URLs where you can obtain information on other Texas Instruments products and application solutions:

### Products

Amplifiers	<a href="http://amplifier.ti.com">amplifier.ti.com</a>
Data Converters	<a href="http://dataconverter.ti.com">dataconverter.ti.com</a>
DLP® Products	<a href="http://www.dlp.com">www.dlp.com</a>
DSP	<a href="http://dsp.ti.com">dsp.ti.com</a>
Clocks and Timers	<a href="http://www.ti.com/clocks">www.ti.com/clocks</a>
Interface	<a href="http://interface.ti.com">interface.ti.com</a>
Logic	<a href="http://logic.ti.com">logic.ti.com</a>
Power Mgmt	<a href="http://power.ti.com">power.ti.com</a>
Microcontrollers	<a href="http://microcontroller.ti.com">microcontroller.ti.com</a>
RFID	<a href="http://www.ti-rfid.com">www.ti-rfid.com</a>
RF/IF and ZigBee® Solutions	<a href="http://www.ti.com/lprf">www.ti.com/lprf</a>

### Applications

Audio	<a href="http://www.ti.com/audio">www.ti.com/audio</a>
Automotive	<a href="http://www.ti.com/automotive">www.ti.com/automotive</a>
Broadband	<a href="http://www.ti.com/broadband">www.ti.com/broadband</a>
Digital Control	<a href="http://www.ti.com/digitalcontrol">www.ti.com/digitalcontrol</a>
Medical	<a href="http://www.ti.com/medical">www.ti.com/medical</a>
Military	<a href="http://www.ti.com/military">www.ti.com/military</a>
Optical Networking	<a href="http://www.ti.com/opticalnetwork">www.ti.com/opticalnetwork</a>
Security	<a href="http://www.ti.com/security">www.ti.com/security</a>
Telephony	<a href="http://www.ti.com/telephony">www.ti.com/telephony</a>
Video & Imaging	<a href="http://www.ti.com/video">www.ti.com/video</a>
Wireless	<a href="http://www.ti.com/wireless">www.ti.com/wireless</a>

Mailing Address: Texas Instruments, Post Office Box 655303, Dallas, Texas 75265  
Copyright © 2009, Texas Instruments Incorporated