

HEXFET® Power MOSFET

- Surface Mount
- Available in Tape & Reel
- Dynamic dv/dt Rating
- Repetitive Avalanche Rated
- Logic-Level Gate Drive
- $R_{DS(on)}$ Specified at $V_{GS}=4V$ & $5V$
- $175^{\circ}C$ Operating Temperature

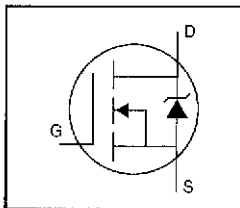

$$V_{DSS} = 100V$$

$$R_{DS(on)} = 0.077\Omega$$

$$I_D = 28A$$

Description

Third Generation HEXFETs from International Rectifier provide the designer with the best combination of fast switching, ruggedized device design, low on-resistance and cost-effectiveness.

The SMD-220 is a surface mount power package capable of accommodating die sizes up to HEX-4. It provides the highest power capability and the lowest possible on-resistance in any existing surface mount package. The SMD-220 is suitable for high current applications because of its low internal connection resistance and can dissipate up to 2.0W in a typical surface mount application.

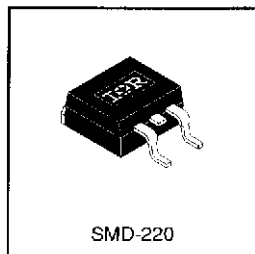

DATA SHEETS

Absolute Maximum Ratings

Parameter		Max.	Units
I_D @ $T_C = 25^{\circ}C$	Continuous Drain Current, $V_{GS} @ 5.0V$	28	A
I_D @ $T_C = 100^{\circ}C$	Continuous Drain Current, $V_{GS} @ 5.0V$	20	
I_{DM}	Pulsed Drain Current ①	110	
P_D @ $T_C = 25^{\circ}C$	Power Dissipation	150	W
P_D @ $T_A = 25^{\circ}C$	Power Dissipation (PCB Mount)**	3.7	
	Linear Derating Factor	1.0	W/ $^{\circ}C$
	Linear Derating Factor (PCB Mount)**	0.025	
V_{GS}	Gate-to-Source Voltage	± 10	V
E_{AS}	Single Pulse Avalanche Energy ②	440	mJ
I_{AR}	Avalanche Current ③	28	A
E_{AR}	Repetitive Avalanche Energy ④	15	mJ
dv/dt	Peak Diode Recovery dv/dt ⑤	5.5	V/ns
T_J, T_{STG}	Junction and Storage Temperature Range	-55 to +175	$^{\circ}C$
	Soldering Temperature, for 10 seconds	300 (1.6mm from case)	

Thermal Resistance

Parameter	Parameter	Min.	Typ.	Max.	Units
$R_{\theta JC}$	Junction-to-Case	—	—	1.0	$^{\circ}C/W$
$R_{\theta JA}$	Junction-to-Ambient (PCB mount)**	—	—	40	
$R_{\theta BA}$	Junction-to-Ambient	—	—	62	

** When mounted on 1" square PCB (FR-4 or G-10 Material).

For recommended footprint and soldering techniques refer to application note #AN-994.

Electrical Characteristics @ $T_J = 25^\circ\text{C}$ (unless otherwise specified)

Parameter		Min.	Typ.	Max.	Units	Test Conditions
$V_{(BR)DSS}$	Drain-to-Source Breakdown Voltage	100	—	—	V	$V_{GS}=0V, I_D=250\mu A$
$\Delta V_{(BR)DSS}/\Delta T_J$	Breakdown Voltage Temp. Coefficient	—	0.12	—	$^\circ\text{C}$	Reference to $25^\circ\text{C}, I_D=1\text{mA}$
$R_{DS(on)}$	Static Drain-to-Source On-Resistance	—	—	0.077	Ω	$V_{GS}=5.0V, I_D=17A$ ④
		—	—	0.11	Ω	$V_{GS}=4.0V, I_D=14A$ ④
$V_{GS(th)}$	Gate Threshold Voltage	1.0	—	2.0	V	$V_{DS}=V_{GS}, I_D=250\mu A$
g_{fs}	Forward Transconductance	12	—	—	S	$V_{DS}=50V, I_D=17A$ ④
I_{DSS}	Drain-to-Source Leakage Current	—	—	25	μA	$V_{DS}=100V, V_{GS}=0V$
		—	—	250	μA	$V_{DS}=80V, V_{GS}=0V, T_J=150^\circ\text{C}$
I_{CSS}	Gate-to-Source Forward Leakage	—	—	100	nA	$V_{GS}=10V$
	Gate-to-Source Reverse Leakage	—	—	-100	nA	$V_{GS}=-10V$
Q_g	Total Gate Charge	—	—	84	nC	$I_D=28A$
Q_{gs}	Gate-to-Source Charge	—	—	9.4	nC	$V_{DS}=80V$
Q_{gd}	Gate-to-Drain ("Miller") Charge	—	—	27	nC	$V_{GS}=5.0V$ See Fig. 6 and 13 ④
$t_{d(on)}$	Turn-On Delay Time	—	8.5	—	ns	$V_{DD}=50V$ $I_D=28A$ $R_G=9.0\Omega$ $R_D=1.7\Omega$ See Figure 10 ④
t_r	Rise Time	—	170	—		
$t_{d(off)}$	Turn-Off Delay Time	—	35	—		
t_f	Fall Time	—	80	—		
L_D	Internal Drain Inductance	—	4.5	—	nH	Between lead, 6 mm (0.25in.) from package and center of die contact 
L_S	Internal Source Inductance	—	7.5	—		
C_{iss}	Input Capacitance	—	2200	—	pF	$V_{GS}=0V$
C_{oss}	Output Capacitance	—	560	—		$V_{DS}=25V$
C_{rss}	Reverse Transfer Capacitance	—	140	—		$f=1.0\text{MHz}$ See Figure 5

Source-Drain Ratings and Characteristics

Parameter		Min.	Typ.	Max.	Units	Test Conditions
I_S	Continuous Source Current (Body Diode)	—	—	28	A	MOSFET symbol showing the integral reverse p-n junction diode. 
I_{SV}	Pulsed Source Current (Body Diode) ③	—	—	110		
V_{SD}	Diode Forward Voltage	—	—	2.5	V	$T_J=25^\circ\text{C}, I_S=28A, V_{GS}=0V$ ④
t_{rr}	Reverse Recovery Time	—	200	260	ns	$T_J=25^\circ\text{C}, I_F=28A$
Q_{rr}	Reverse Recovery Charge	—	1.7	2.9	μC	$dI/dt=100A/\mu\text{s}$ ④
t_{on}	Forward Turn-On Time	Intrinsic turn-on time is negligible (turn-on is dominated by L_S+L_D)				

Notes:

① Repetitive rating; pulse width limited by max. junction temperature (See Figure 11)

③ $I_{SP} \leq 28A, dI/dt \leq 170A/\mu\text{s}, V_{DS} \leq V_{(BR)DSS}, T_J \leq 175^\circ\text{C}$

④ $V_{DD}=25V, \text{ starting } T_J=25^\circ\text{C}, L=84\mu\text{H}, R_G=25\Omega, I_{AS}=28A$ (See Figure 12)

④ Pulse width $\leq 300\mu\text{s}$; duty cycle $\leq 2\%$.

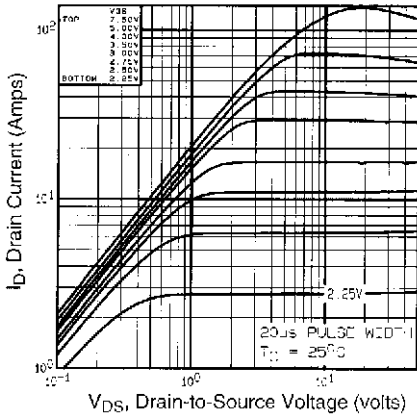

Fig 1. Typical Output Characteristics,
 $T_C=25^\circ\text{C}$

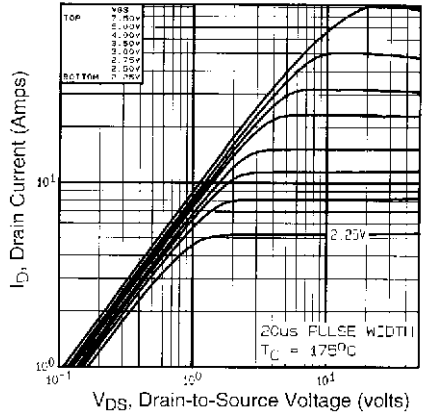

Fig 2. Typical Output Characteristics,
 $T_C=175^\circ\text{C}$

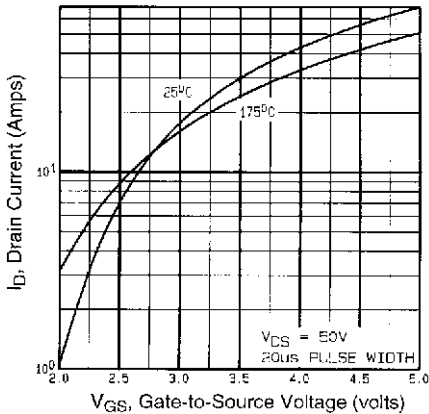

Fig 3. Typical Transfer Characteristics

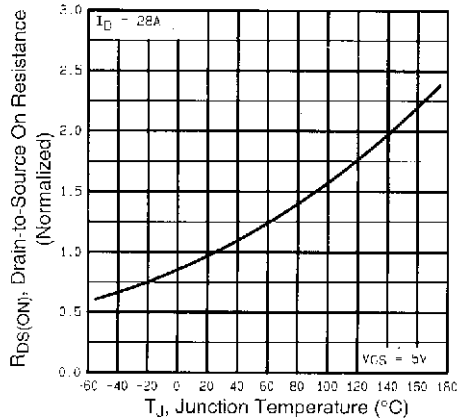

Fig 4. Normalized On-Resistance
Vs. Temperature

DATA SHEETS

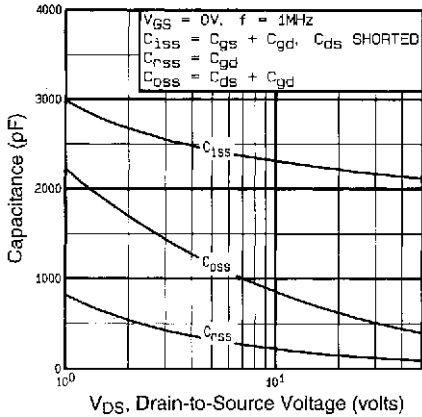

Fig 5. Typical Capacitance Vs. Drain-to-Source Voltage

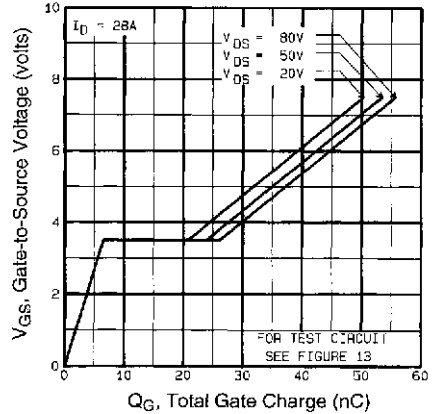

Fig 6. Typical Gate Charge Vs. Gate-to-Source Voltage

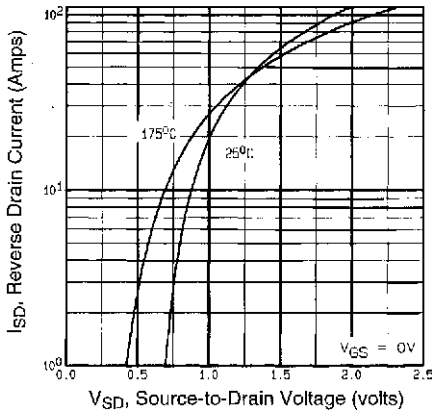

Fig 7. Typical Source-Drain Diode Forward Voltage

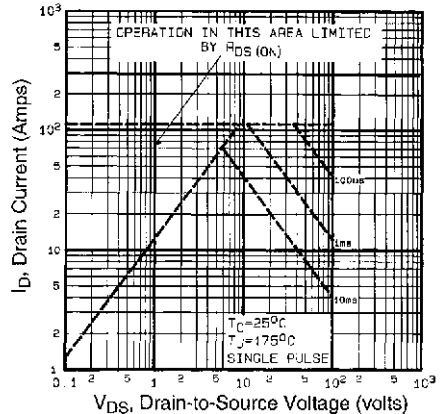

Fig 8. Maximum Safe Operating Area

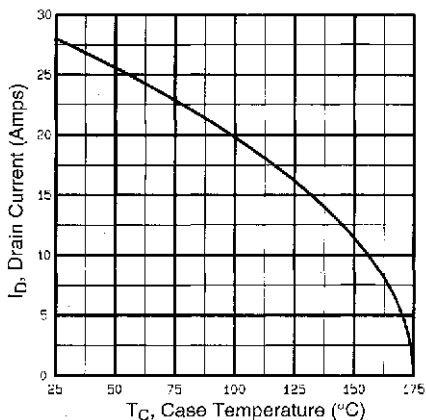

Fig 9. Maximum Drain Current Vs. Case Temperature

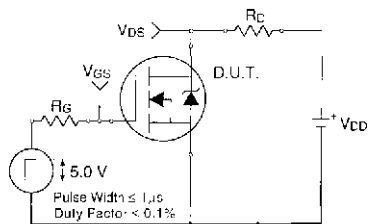

Fig 10a. Switching Time Test Circuit

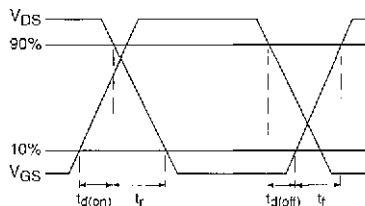

Fig 10b. Switching Time Waveforms

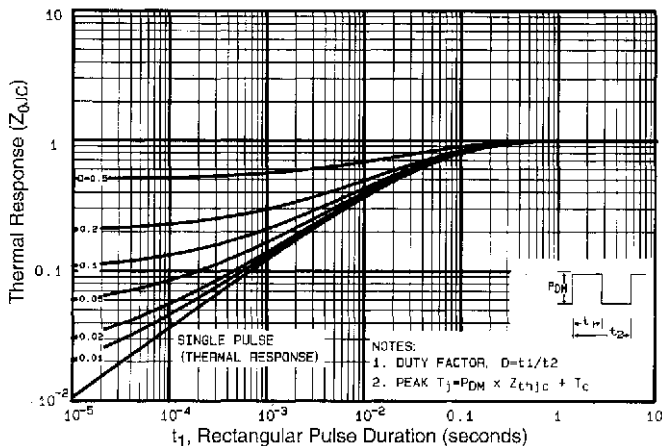

Fig 11. Maximum Effective Transient Thermal Impedance, Junction-to-Case

DATA SHEETS

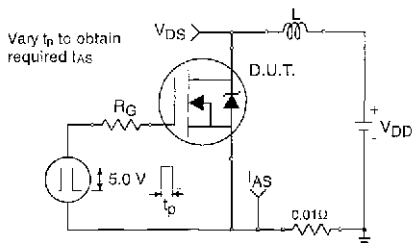

Fig 12a. Unclamped Inductive Test Circuit

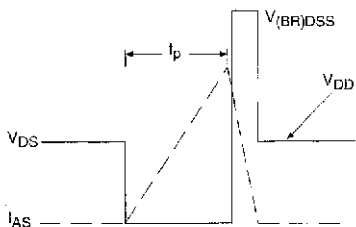

Fig 12b. Unclamped Inductive Waveforms

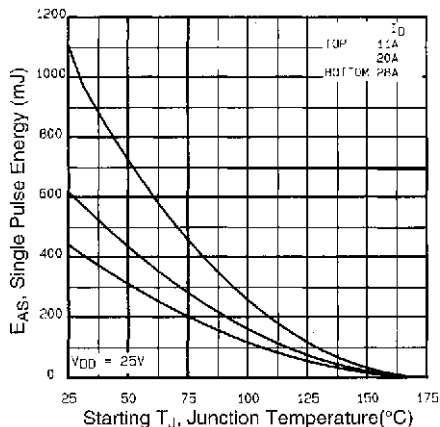

Fig 12c. Maximum Avalanche Energy Vs. Drain Current

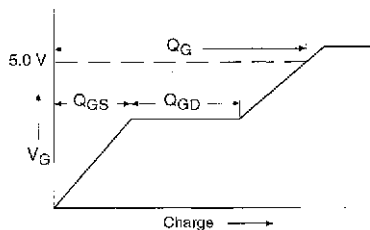

Fig 13a. Basic Gate Charge Waveform

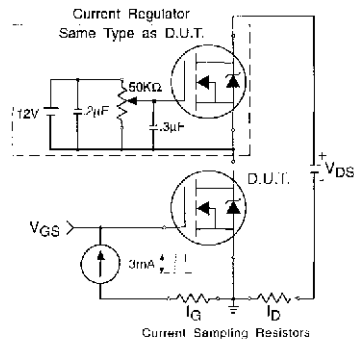

Fig 13b. Gate Charge Test Circuit

Appendix A: Figure 14, Peak Diode Recovery dv/dt Test Circuit – See page 1505

Appendix B: Package Outline Mechanical Drawing – See page 1507

Appendix C: Part Marking Information – See page 1515

Appendix D: Tape & Reel Information – See page 1519



Notice

The products described herein were acquired by Vishay Intertechnology, Inc., as part of its acquisition of International Rectifier's Power Control Systems (PCS) business, which closed in April 2007. Specifications of the products displayed herein are pending review by Vishay and are subject to the terms and conditions shown below.

Specifications of the products displayed herein are subject to change without notice. Vishay Intertechnology, Inc., or anyone on its behalf, assumes no responsibility or liability for any errors or inaccuracies.

Information contained herein is intended to provide a product description only. No license, express or implied, by estoppel or otherwise, to any intellectual property rights is granted by this document. Except as provided in Vishay's terms and conditions of sale for such products, Vishay assumes no liability whatsoever, and disclaims any express or implied warranty, relating to sale and/or use of Vishay products including liability or warranties relating to fitness for a particular purpose, merchantability, or infringement of any patent, copyright, or other intellectual property right.

The products shown herein are not designed for use in medical, life-saving, or life-sustaining applications. Customers using or selling these products for use in such applications do so at their own risk and agree to fully indemnify Vishay for any damages resulting from such improper use or sale.

International Rectifier®, IR®, the IR logo, HEXFET®, HEXSense®, HEXDIP®, DOL®, INTERO®, and POWIRTRAIN® are registered trademarks of International Rectifier Corporation in the U.S. and other countries. All other product names noted herein may be trademarks of their respective owners.