

HEXFET® Power MOSFET

- Isolated Package
- High Voltage Isolation= 2.5KV RMS ⑤
- Sink to Lead Creepage Dist.= 4.8mm
- Logic-Level Gate Drive
- $R_{DS(on)}$ Specified at $V_{GS}=4V$ & $5V$
- Fast Switching
- Ease of Paralleling

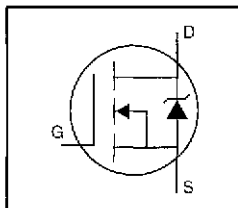

$$V_{DSS} = 60V$$

$$R_{DS(on)} = 0.10\Omega$$

$$I_D = 14A$$

Description

Third Generation HEXFETs from International Rectifier provide the designer with the best combination of fast switching, ruggedized device design, low on-resistance and cost-effectiveness.

The TO-220 Fullpak eliminates the need for additional insulating hardware in commercial-industrial applications. The moulding compound used provides a high isolation capability and a low thermal resistance between the tab and external heatsink. This isolation is equivalent to using a 100 micron mica barrier with standard TO-220 product. The Fullpak is mounted to a heatsink using a single clip or by a single screw fixing.

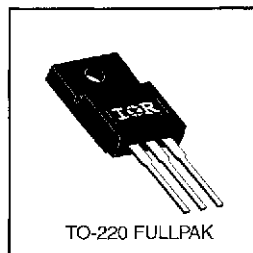
TO-220 FULLPAK
Absolute Maximum Ratings

| | Parameter | Max. | Units |
|-----------------------------|--|-----------------------|-------|
| I_D @ $T_C = 25^\circ C$ | Continuous Drain Current, $V_{GS} @ 5.0 V$ | 14 | A |
| I_D @ $T_C = 100^\circ C$ | Continuous Drain Current, $V_{GS} @ 5.0 V$ | 10 | |
| I_{DM} | Pulsed Drain Current ① | 56 | |
| P_D @ $T_C = 25^\circ C$ | Power Dissipation | 37 | W |
| | Linear Derating Factor | 0.24 | W/°C |
| V_{GS} | Gate-to-Source Voltage | ± 10 | V |
| E_{AS} | Single Pulse Avalanche Energy ② | 100 | mJ |
| dv/dt | Peak Diode Recovery dv/dt ③ | 4.5 | V/ns |
| T_J | Operating Junction and | -55 to +175 | °C |
| T_{STG} | Storage Temperature Range | | |
| | Soldering Temperature, for 10 seconds | 300 (1.6mm from case) | |
| | Mounting Torque, 6-32 or M3 screw | 10 lbf-in (1.1 N-m) | |

Thermal Resistance

| | Parameter | Min. | Typ. | Max. | Units |
|-----------------|---------------------|------|------|------|-------|
| $R_{\theta JC}$ | Junction-to-Case | — | — | 4.1 | °C/W |
| $R_{\theta JA}$ | Junction-to-Ambient | — | — | 65 | |

Electrical Characteristics @ T_J = 25°C (unless otherwise specified)

| | Parameter | Min. | Typ. | Max. | Units | Test Conditions |
|--------------------------------------|--------------------------------------|------|-------|------|-------|---|
| V _{(BR)DSS} | Drain-to-Source Breakdown Voltage | 60 | — | — | V | V _{GS} =0V, I _D =250μA |
| ΔV _{(BR)DSS/ΔT_J} | Breakdown Voltage Temp. Coefficient | — | 0.065 | — | V/°C | Reference to 25°C, I _D =1mA |
| R _{D(on)} | Static Drain-to-Source On-Resistance | — | — | 0.10 | Ω | V _{GS} =5.0V, I _D =8.4A ④ V _{GS} =4.0V, I _D =7.0A ④ |
| V _{GS(th)} | Gate Threshold Voltage | 1.0 | — | 2.0 | V | V _{DS} =V _{GS} , I _D =250μA |
| g _{fs} | Forward Transconductance | 7.3 | — | — | S | V _{DS} =25V, I _D =8.4A ④ |
| I _{DSS} | Drain-to-Source Leakage Current | — | — | 25 | μA | V _{DS} =60V, V _{GS} =0V V _{DS} =48V, V _{GS} =0V, T _J =150°C |
| I _{GSS} | Gate-to-Source Forward Leakage | — | — | 100 | nA | V _{GS} =10V |
| | Gate-to-Source Reverse Leakage | — | — | -100 | | V _{GS} =-10V |
| Q _g | Total Gate Charge | — | — | 18 | nC | I _D =17A V _{DS} =48V |
| Q _{gs} | Gate-to-Source Charge | — | — | 4.5 | | V _{GS} =5.0V See Fig. 6 and 13 ④ |
| Q _{gd} | Gate-to-Drain ("Miller") Charge | — | — | 12 | | |
| t _{d(on)} | Turn-On Delay Time | — | 11 | — | ns | V _{DD} =30V I _D =17A R _G =9.0Ω |
| t _r | Rise Time | — | 110 | — | | |
| t _{d(off)} | Turn-Off Delay Time | — | 23 | — | | |
| t _f | Fall Time | — | 41 | — | | R _D =1.7Ω See Figure 10 ④ |
| L _D | Internal Drain Inductance | — | 4.5 | — | nH | Between lead, 6 mm (0.25in.) from package and center of die contact |
| L _S | Internal Source Inductance | — | 7.5 | — | | |
| C _{iss} | Input Capacitance | — | 870 | — | pF | V _{GS} =0V V _{DS} =25V f=1.0MHz See Figure 5 |
| C _{oss} | Output Capacitance | — | 360 | — | | |
| C _{rss} | Reverse Transfer Capacitance | — | 53 | — | | |
| C | Drain to Sink Capacitance | — | 12 | — | | |

Source-Drain Ratings and Characteristics

| | Parameter | Min. | Typ. | Max. | Units | Test Conditions |
|-----------------|---|--|------|------|-------|---|
| I _S | Continuous Source Current (Body Diode) | — | — | 14 | A | MOSFET symbol showing the integral reverse p-n junction diode. |
| I _{SM} | Pulsed Source Current (Body Diode) ① | — | — | 56 | | |
| V _{SD} | Diode Forward Voltage | — | — | 1.5 | V | T _J =25°C, I _S =14A, V _{GS} =0V ④ |
| t _{rr} | Reverse Recovery Time | — | 130 | 260 | ns | T _J =25°C, I _F =17A |
| Q _{rr} | Reverse Recovery Charge | — | 0.75 | 1.5 | μC | di/dt=100A/μs ④ |
| t _{on} | Forward Turn-On Time | Intrinsic turn-on time is negligible (turn-on is dominated by L _S +L _D) | | | | |

Notes:

- ① Repetitive rating; pulse width limited by max. junction temperature (See Figure 11)
- ② V_{DD}=25V, starting T_J=25°C, L=595μH
R_G=25Ω, I_{AS}=14A (See Figure 12)
- ③ I_{SD}≤17A, di/dt≤140A/μs, V_{DD}≤V_{(BR)DSS}, T_J≤175°C
- ④ Pulse width < 300 μs; duty cycle ≤2%
- ⑤ t=60s, f=60Hz

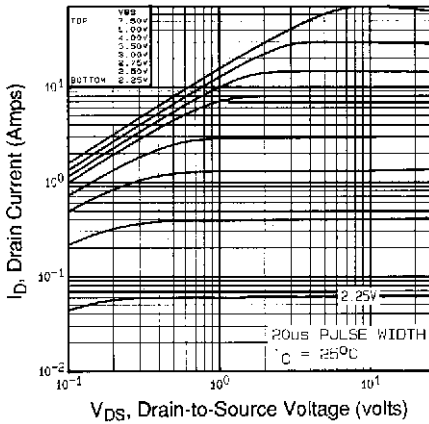

Fig 1. Typical Output Characteristics,
 $T_C = 25^\circ\text{C}$

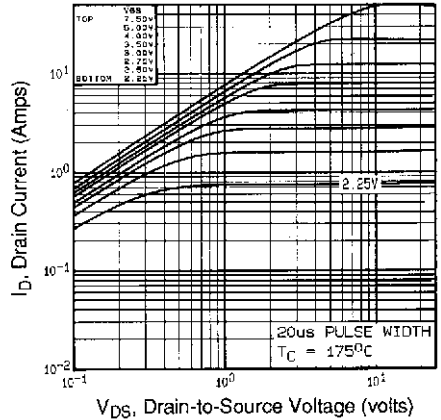

Fig 2. Typical Output Characteristics,
 $T_C = 175^\circ\text{C}$

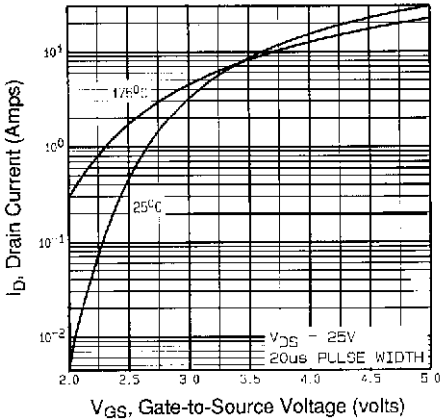

Fig 3. Typical Transfer Characteristics

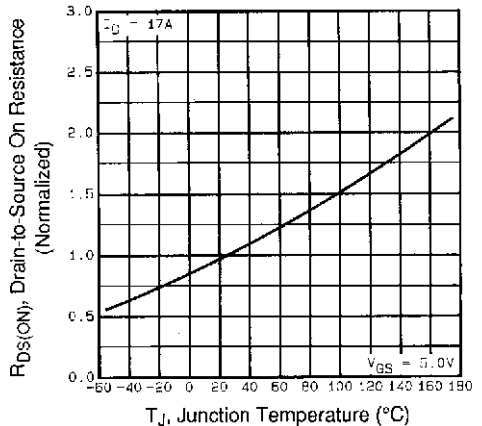

Fig 4. Normalized On-Resistance
Vs. Temperature

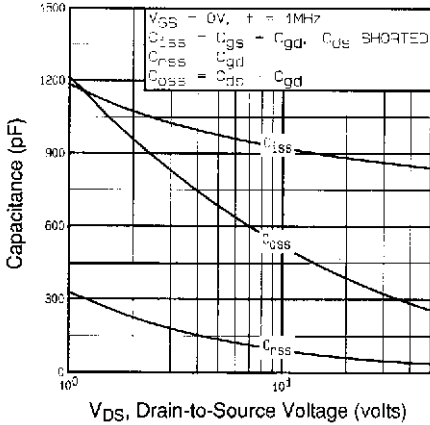

Fig 5. Typical Capacitance Vs. Drain-to-Source Voltage

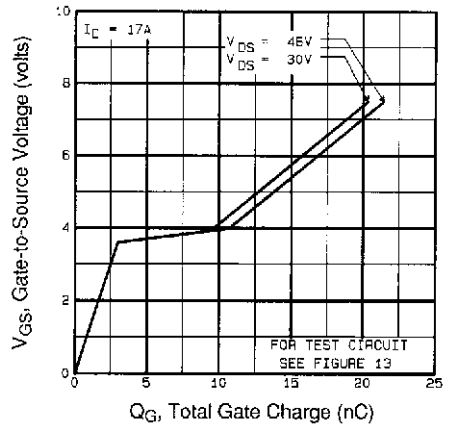

Fig 6. Typical Gate Charge Vs. Gate-to-Source Voltage

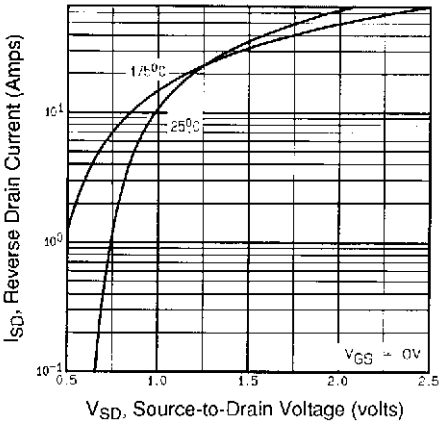

Fig 7. Typical Source-Drain Diode Forward Voltage

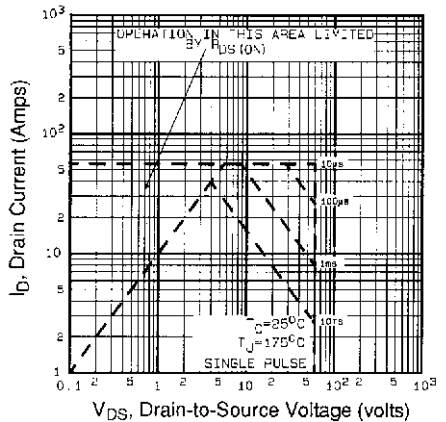

Fig 8. Maximum Safe Operating Area

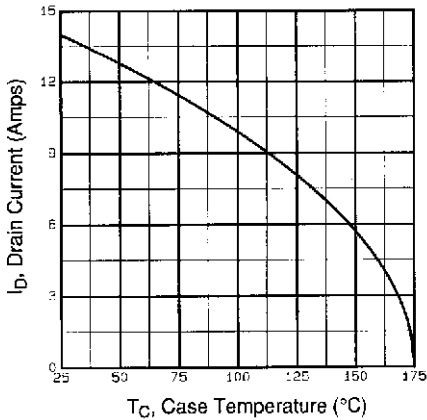

Fig 9. Maximum Drain Current Vs. Case Temperature

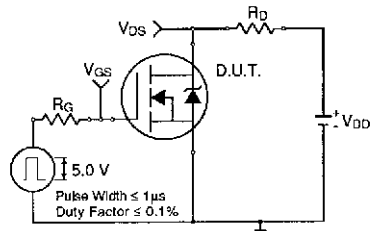

Fig 10a. Switching Time Test Circuit

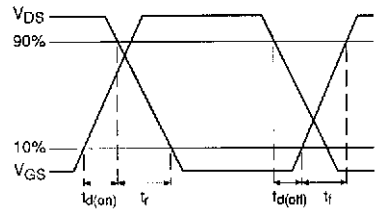

Fig 10b. Switching Time Waveforms

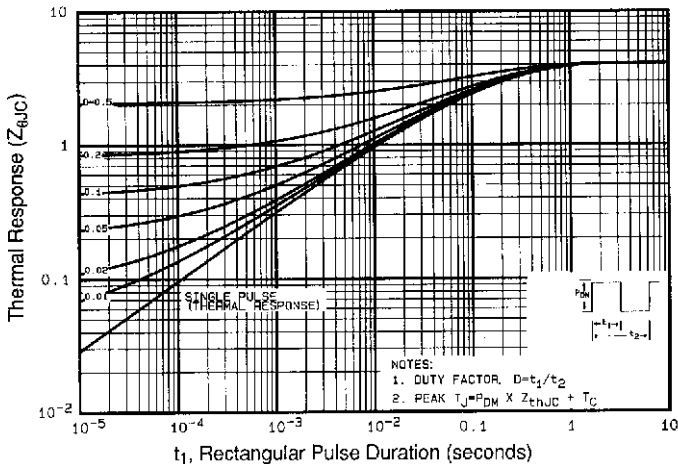

Fig 11. Maximum Effective Transient Thermal Impedance, Junction-to-Case

DATA SHEETS

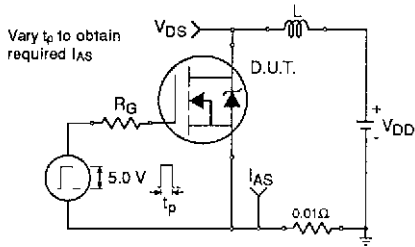

Fig 12a. Unclamped Inductive Test Circuit

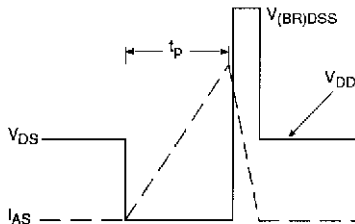

Fig 12b. Unclamped Inductive Waveforms

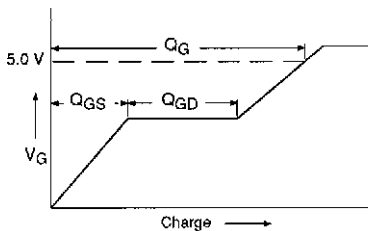

Fig 13a. Basic Gate Charge Waveform

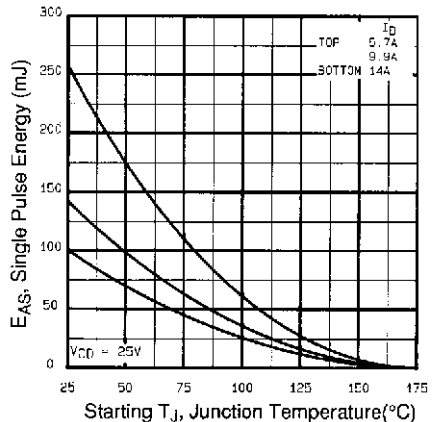

Fig 12c. Maximum Avalanche Energy Vs. Drain Current

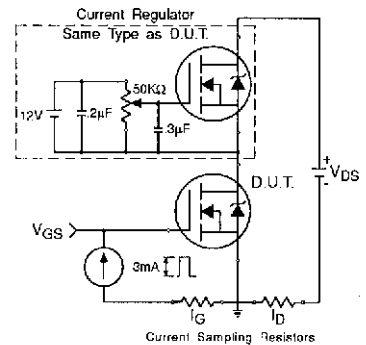

Fig 13b. Gate Charge Test Circuit

Appendix A: Figure 14, Peak Diode Recovery dv/dt Test Circuit – See page 1505

Appendix B: Package Outline Mechanical Drawing – See page 1510

Appendix C: Part Marking Information – See page 1517



Notice

The products described herein were acquired by Vishay Intertechnology, Inc., as part of its acquisition of International Rectifier's Power Control Systems (PCS) business, which closed in April 2007. Specifications of the products displayed herein are pending review by Vishay and are subject to the terms and conditions shown below.

Specifications of the products displayed herein are subject to change without notice. Vishay Intertechnology, Inc., or anyone on its behalf, assumes no responsibility or liability for any errors or inaccuracies.

Information contained herein is intended to provide a product description only. No license, express or implied, by estoppel or otherwise, to any intellectual property rights is granted by this document. Except as provided in Vishay's terms and conditions of sale for such products, Vishay assumes no liability whatsoever, and disclaims any express or implied warranty, relating to sale and/or use of Vishay products including liability or warranties relating to fitness for a particular purpose, merchantability, or infringement of any patent, copyright, or other intellectual property right.

The products shown herein are not designed for use in medical, life-saving, or life-sustaining applications. Customers using or selling these products for use in such applications do so at their own risk and agree to fully indemnify Vishay for any damages resulting from such improper use or sale.

International Rectifier®, IR®, the IR logo, HEXFET®, HEXSense®, HEXDIP®, DOL®, INTERO®, and POWIRTRAIN® are registered trademarks of International Rectifier Corporation in the U.S. and other countries. All other product names noted herein may be trademarks of their respective owners.