



P-Channel 20-V (D-S) MOSFET with Schottky Diode

PRODUCT SUMMARY			
V_{DS} (V)	$r_{DS(on)}$ (Ω)	I_D (A) ^a	Q_g (Typ)
- 20	0.070 at $V_{GS} = - 5.0$ V	- 5.0	4.5 nC
	0.105 at $V_{GS} = - 2.5$ V	- 4.2	

SCHOTTKY PRODUCT SUMMARY		
V_{KA} (V)	V_f (V) Diode Forward Voltage	I_F (A) ^a
20	0.45 at 1 A	2

FEATURES

- LITTLE FOOT[®] Plus Schottky Power MOSFET



APPLICATIONS

- HDD
- DC-DC Converter
- Asynchronous Rectification

RoHS
COMPLIANT

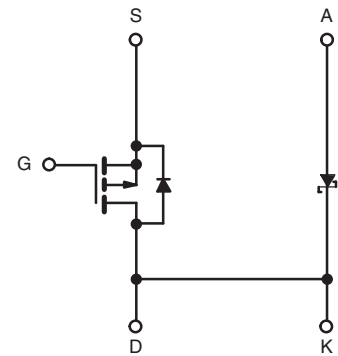
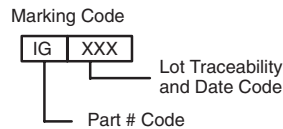
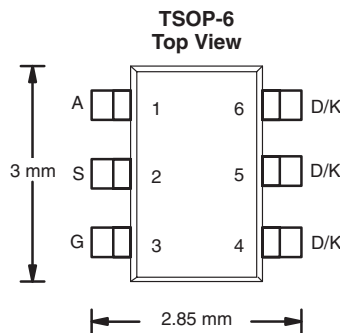

Ordering Information: Si3879DV-T1-E3 (Lead (Pb)-free)

P-Channel MOSFET

ABSOLUTE MAXIMUM RATINGS $T_A = 25$ °C, unless otherwise noted				
Parameter	Symbol	Limit	Unit	
Drain-Source Voltage (MOSFET)	V_{DS}	- 20	V	
Reverse Voltage (Schottky)	V_{KA}	20		
Gate-Source Voltage (MOSFET)	V_{GS}	± 12		
Continuous Drain Current ($T_J = 150$ °C) (MOSFET)	I_D	$T_C = 25$ °C	- 5.0	A
		$T_C = 70$ °C	- 4.0	
		$T_A = 25$ °C	- 4.0 ^{b, c}	
		$T_A = 70$ °C	- 3.0 ^{b, c}	
Pulsed Drain Current (MOSFET)	I_{DM}	- 20		
Continuous Source-Drain Diode Current (MOSFET Diode Conduction)	I_S	$T_C = 25$ °C	- 2.7	
		$T_A = 25$ °C	- 1.6 ^{b, c}	
Average Forward Current (Schottky)	I_F	2 ^b		
Pulsed Forward Current (Schottky)	I_{FM}	5		
Maximum Power Dissipation (MOSFET)	P_D	$T_C = 25$ °C	3.3	W
		$T_C = 70$ °C	2.1	
		$T_A = 25$ °C	2.0 ^{b, c}	
		$T_A = 70$ °C	1.2 ^{b, c}	
Maximum Power Dissipation (Schottky)	P_D	$T_C = 25$ °C	1.9	
		$T_C = 70$ °C	1.2	
		$T_A = 25$ °C	1.3 ^{b, c}	
		$T_A = 70$ °C	0.9 ^{b, c}	
Operating Junction and Storage Temperature Range	T_J, T_{stg}	- 55 to 150	°C	

**THERMAL RESISTANCE RATINGS**

Parameter		Symbol	Typical	Maximum	Unit
Maximum Junction-to-Ambient (MOSFET) ^{b, d}	t ≤ 5 sec	R _{thJA}	51	62.5	°C/W
Maximum Junction-to-Foot (Drain) (MOSFET)	Steady State	R _{thJF}	30	37	
Maximum Junction-to-Ambient (Schottky) ^{b, e}	t ≤ 5 sec	R _{thJA}	73	90	
Maximum Junction-to-Foot (Drain) (Schottky)	Steady State	R _{thJF}	50	65	

Notes:

- a. Based on T_C = 25 °C.
 b. Surface Mounted on 1" x 1" FR4 board.
 c. t = 5 sec.
 d. Maximum under Steady State conditions is 105 °C/W.
 e. Maximum under Steady State conditions is 125 °C/W.

SPECIFICATIONS T_J = 25 °C, unless otherwise noted

Parameter	Symbol	Test Conditions	Min	Typ	Max	Unit
Static						
Drain-Source Breakdown Voltage	V _{DS}	V _{GS} = 0 V, I _D = - 250 μA	- 20			V
V _{DS} Temperature Coefficient	ΔV _{DS} /T _J	I _D = - 250 μA		- 20		mV/°C
V _{GS(th)} Temperature Coefficient	ΔV _{GS(th)} /T _J		3			
Gate-Source Threshold Voltage	V _{GS(th)}	V _{DS} = V _{GS} , I _D = - 250 μA	- 0.6		- 1.5	V
Gate-Source Leakage	I _{GSS}	V _{DS} = 0 V, V _{GS} = ± 12 V			± 100	nA
Zero Gate Voltage Drain Current	I _{DSS}	V _{DS} = - 20 V, V _{GS} = 0 V			- 1	μA
		V _{DS} = - 20 V, V _{GS} = 0 V, T _J = 55 °C			- 10	
On-State Drain Current ^a	I _{D(on)}	V _{DS} ≤ 5 V, V _{GS} = - 4.5 V	- 8			A
Drain-Source On-State Resistance ^a	r _{DS(on)}	V _{GS} = - 4.5 V, I _D = - 3.5 A		0.058	0.070	Ω
		V _{GS} = - 2.5 V, I _D = - 3.0 A		0.085	0.105	
Forward Transconductance ^a	g _{fs}	V _{DS} = - 10 V, I _D = - 3.5 A		10		S
Dynamic^b						
Input Capacitance	C _{iss}	V _{DS} = - 10 V, V _{GS} = 0 V, f = 1 MHz		480		pF
Output Capacitance	C _{oss}			132		
Reverse Transfer Capacitance	C _{rss}			55		
Total Gate Charge	Q _g	V _{DS} = - 10 V, V _{GS} = - 10 V, I _D = - 5.0 A		9.7	14.5	nC
				4.5	7	
Gate-Source Charge	Q _{gs}	V _{DS} = - 10 V, V _{GS} = - 4.5 V, I _D = - 4.5 A		1.0		
Gate-Drain Charge	Q _{gd}			1.0		
Gate Resistance	R _g	f = 1 MHz		7.5		Ω
Turn-On Delay Time	t _{d(on)}	V _{DD} = - 10 V, R _L = 2.0 Ω I _D ≅ - 5.0 A, V _{GEN} = - 10 V, R _g = 1 Ω		6	10	ns
Rise Time	t _r			54	85	
Turn-Off DelayTime	t _{d(off)}			19	30	
Fall Time	t _f			8	15	
Turn-On Delay Time	t _{d(on)}	V _{DD} = - 10 V, R _L = 2.0 Ω I _D ≅ - 5.0 A, V _{GEN} = - 4.5 V, R _g = 1 Ω		26	40	
Rise Time	t _r			80	120	
Turn-Off DelayTime	t _{d(off)}			20	30	
Fall Time	t _f			10	15	



SPECIFICATIONS $T_J = 25\text{ }^\circ\text{C}$, unless otherwise noted						
Parameter	Symbol	Test Conditions	Min	Typ	Max	Unit
Drain-Source Body Diode Characteristics						
Continuous Source-Drain Diode Current	I_S	$T_C = 25\text{ }^\circ\text{C}$			- 2.7	A
Pulse Diode Forward Current	I_{SM}				- 20	
Body Diode Voltage	V_{SD}	$I_S = - 1.0\text{ A}, V_{GS} = 0\text{ V}$		- 0.75	- 1.2	V
Body Diode Reverse Recovery Time	t_{rr}	$I_F = - 3.5\text{ A}, di/dt = 100\text{ A}/\mu\text{s}, T_J = 25\text{ }^\circ\text{C}$		25	40	ns
Body Diode Reverse Recovery Charge	Q_{rr}			12	20	nC
Reverse Recovery Fall Time	t_a			9		ns
Reverse Recovery Rise Time	t_b			16		

Notes:

- a. Pulse test; pulse width $\leq 300\text{ }\mu\text{s}$, duty cycle $\leq 2\%$.
 b. Guaranteed by design, not subject to production testing.

SCHOTTKY SPECIFICATIONS $T_J = 25\text{ }^\circ\text{C}$, unless otherwise noted						
Parameter	Symbol	Test Conditions	Min	Typ	Max	Unit
Forward Voltage Drop	V_F	$I_F = 1\text{ A}$		0.41	0.45	V
		$I_F = 1\text{ A}, T_J = 125\text{ }^\circ\text{C}$		0.36	0.41	
Maximum Reverse Leakage Current	I_{rm}	$V_r = 5\text{ V}$		0.015	0.08	mA
		$V_r = 5\text{ V}, T_J = 85\text{ }^\circ\text{C}$		0.50	5.00	
		$V_r = 20\text{ V}$		0.02	0.10	
		$V_r = 20\text{ V}, T_J = 85\text{ }^\circ\text{C}$		0.7	7.00	
		$V_r = 20\text{ V}, T_J = 125\text{ }^\circ\text{C}$		5	50	
Junction Capacitance	C_T	$V_r = 10\text{ V}$		60		pF

Stresses beyond those listed under "Absolute Maximum Ratings" may cause permanent damage to the device. These are stress ratings only, and functional operation of the device at these or any other conditions beyond those indicated in the operational sections of the specifications is not implied. Exposure to absolute maximum rating conditions for extended periods may affect device reliability.



MOSFET TYPICAL CHARACTERISTICS $T_A = 25\text{ }^\circ\text{C}$, unless otherwise noted

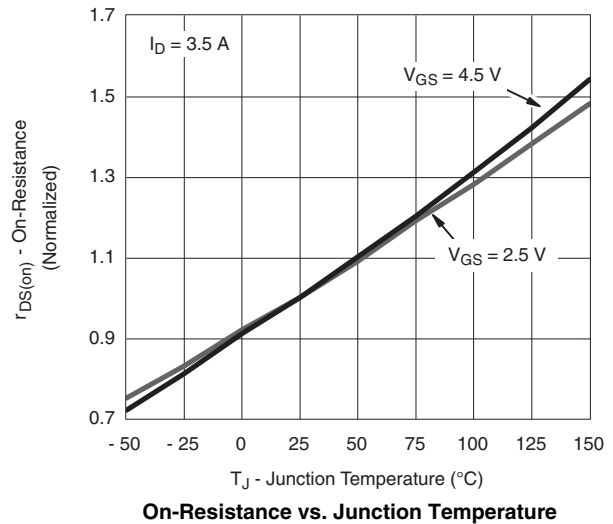
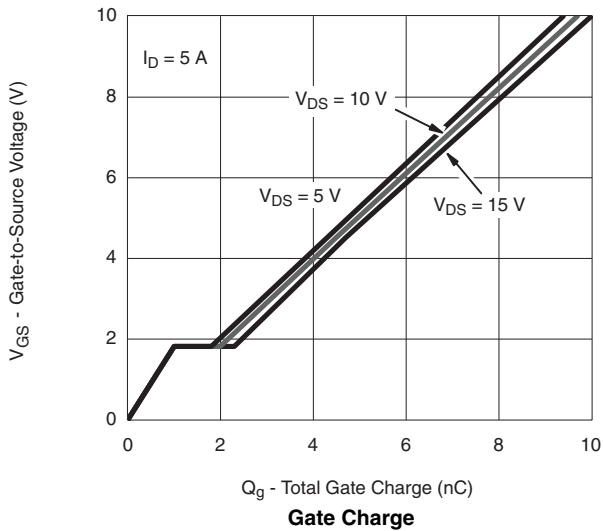
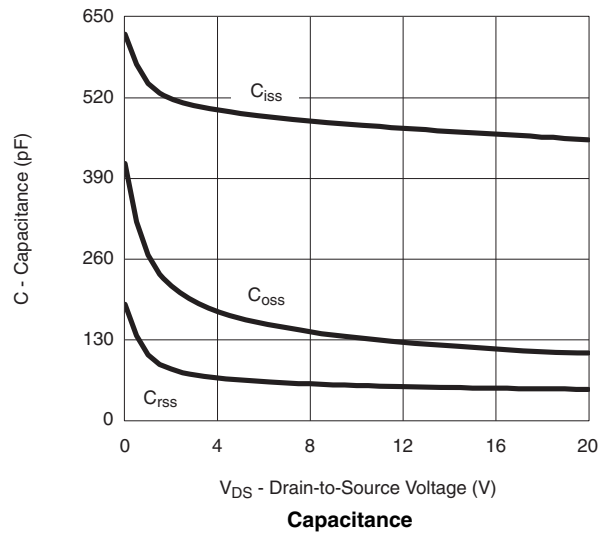
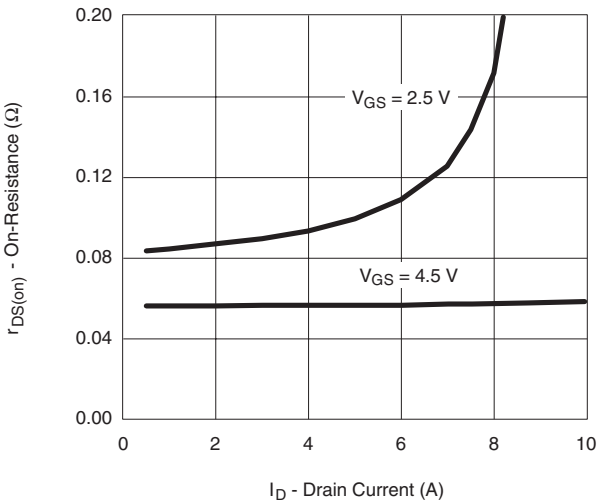
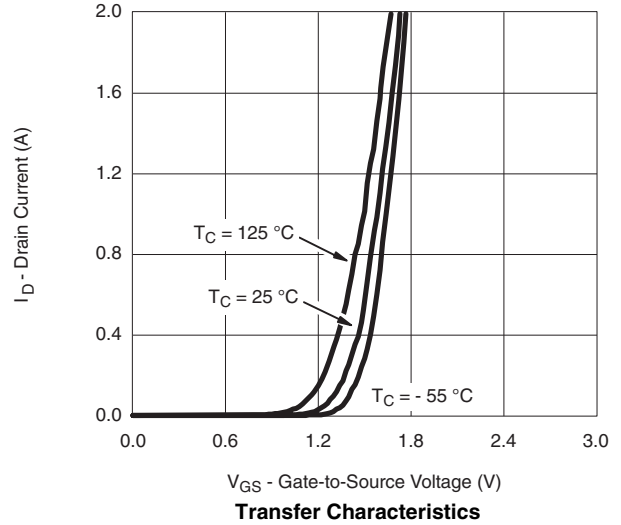
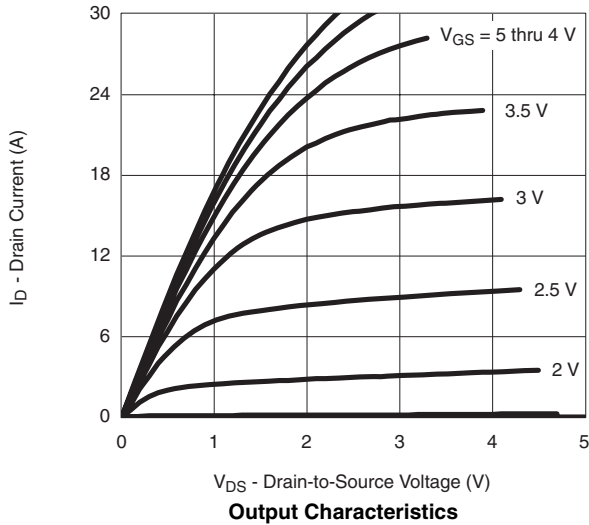



MOSFET TYPICAL CHARACTERISTICS $T_A = 25\text{ }^\circ\text{C}$, unless otherwise noted

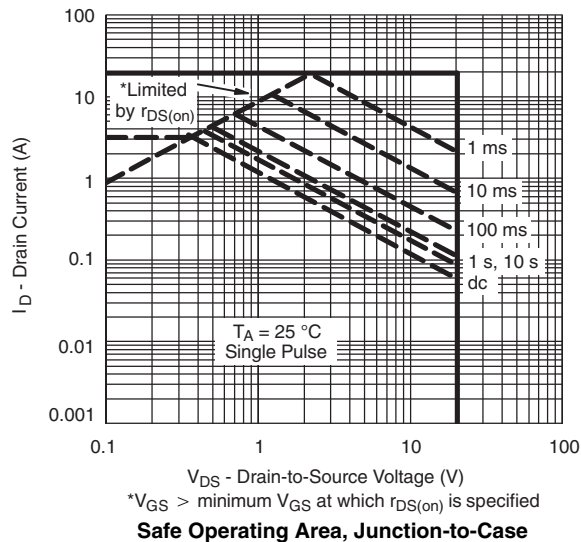
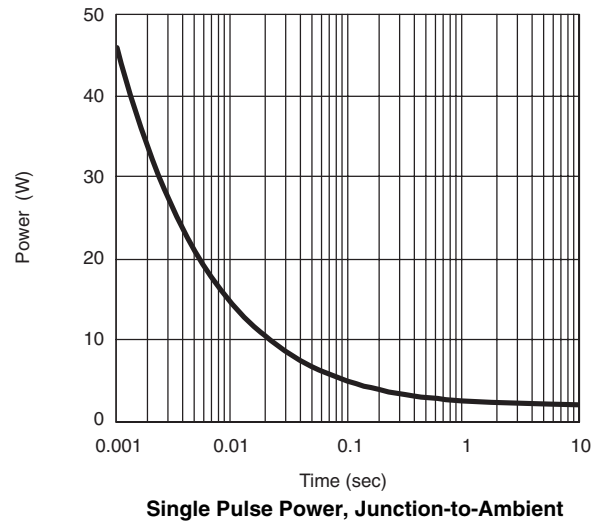
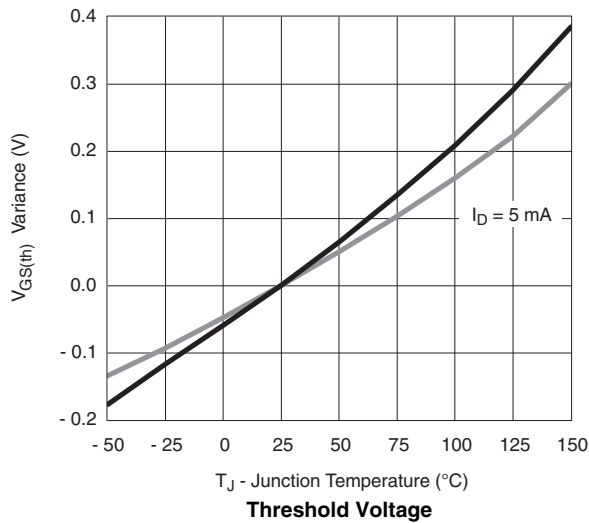
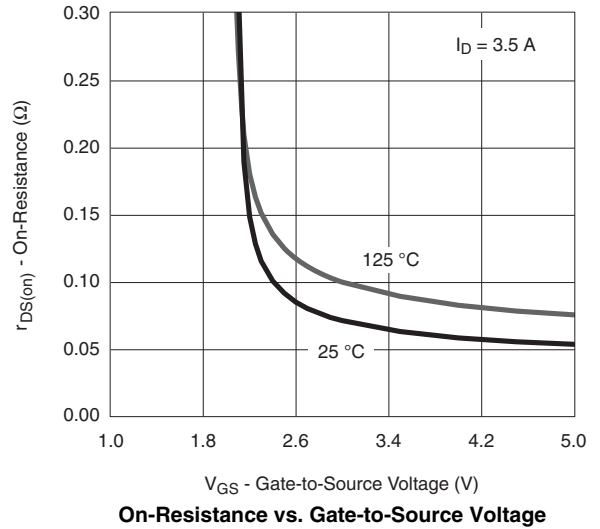
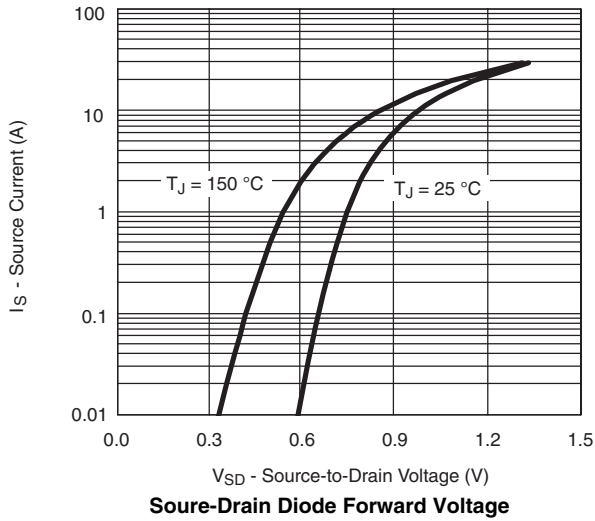



MOSFET TYPICAL CHARACTERISTICS $T_A = 25\text{ }^\circ\text{C}$, unless otherwise noted

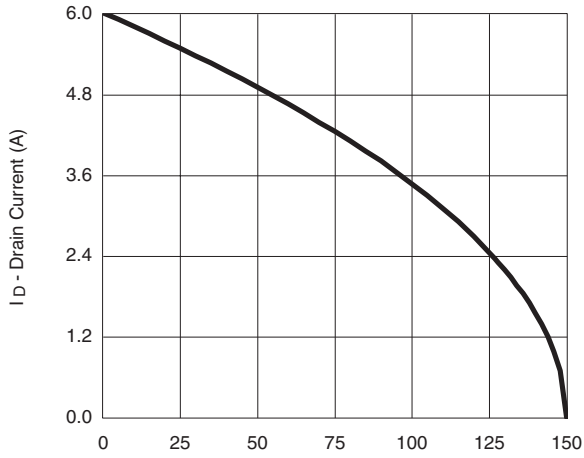

T_C - Case Temperature (°C)

Current Derating*

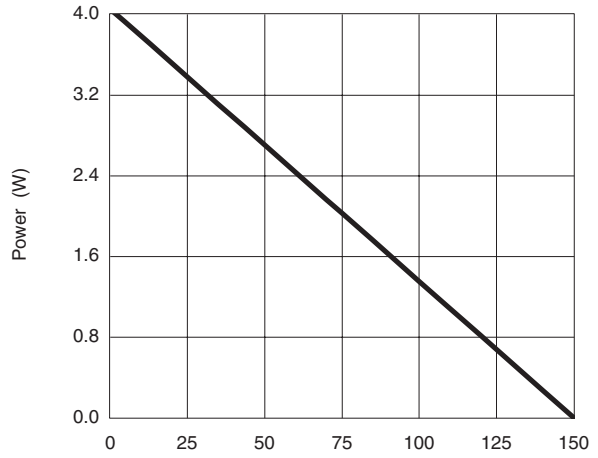

T_C - Case Temperature (°C)

Power Derating, Junction-to-Foot

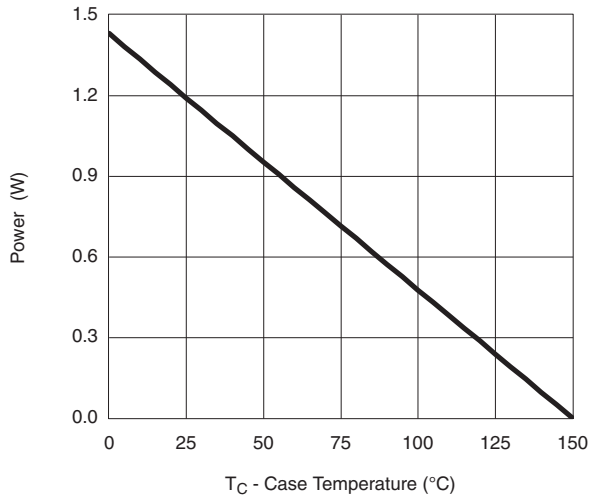

T_C - Case Temperature (°C)

Power Derating, Junction-to-Ambient

*The power dissipation P_D is based on $T_{J(max)} = 150\text{ }^\circ\text{C}$, using junction-to-case thermal resistance, and is more useful in settling the upper dissipation limit for cases where additional heatsinking is used. It is used to determine the current rating, when this rating falls below the package limit.



MOSFET TYPICAL CHARACTERISTICS $T_A = 25\text{ }^\circ\text{C}$, unless otherwise noted

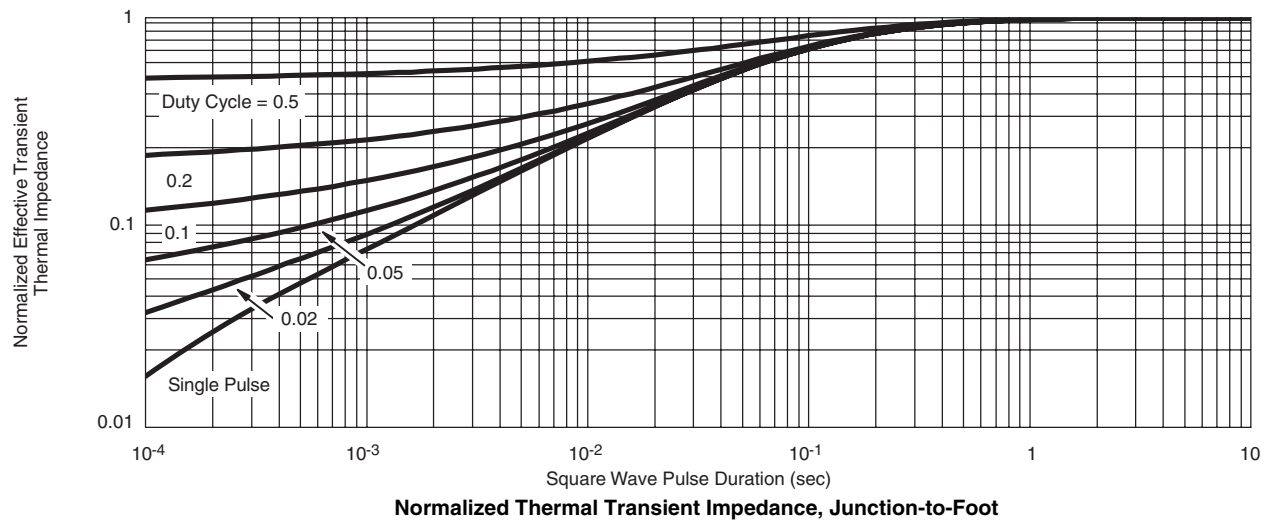
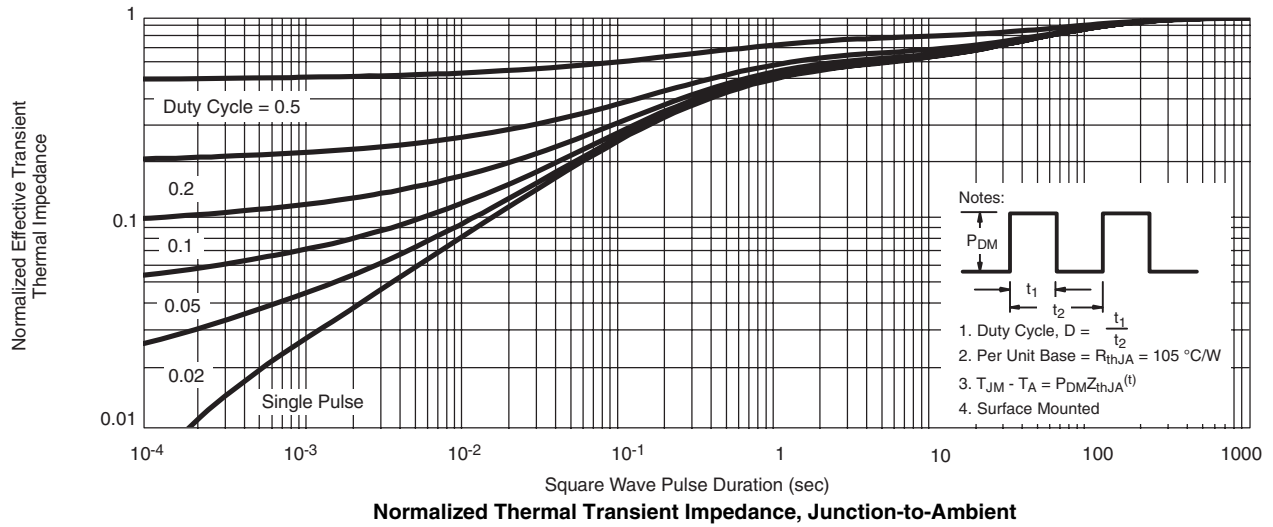



SCHOTTKY TYPICAL CHARACTERISTICS $T_A = 25\text{ }^\circ\text{C}$, unless otherwise noted

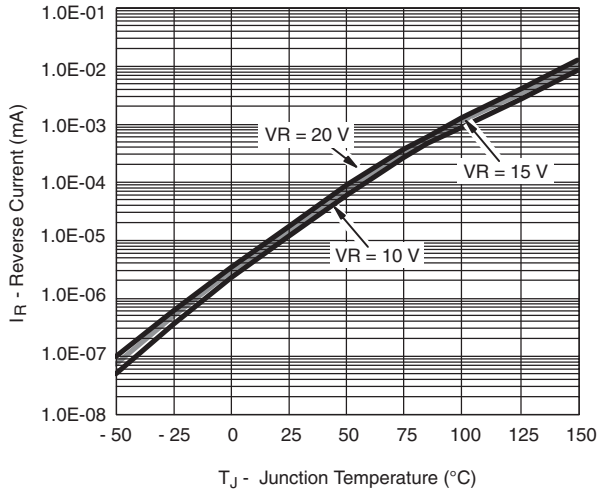

Reverse Current vs. Junction Temperature

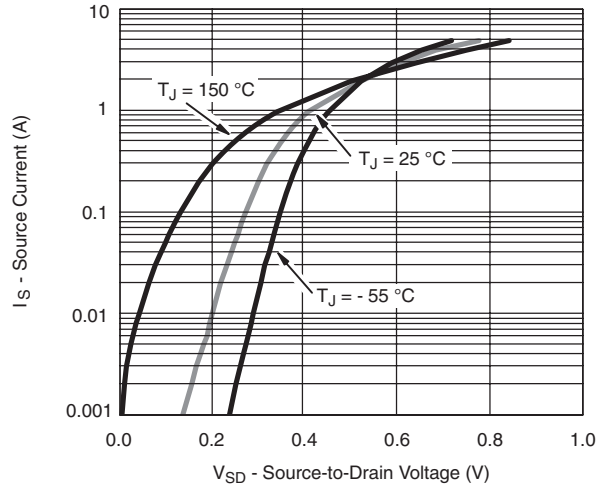

Forward Diode Voltage

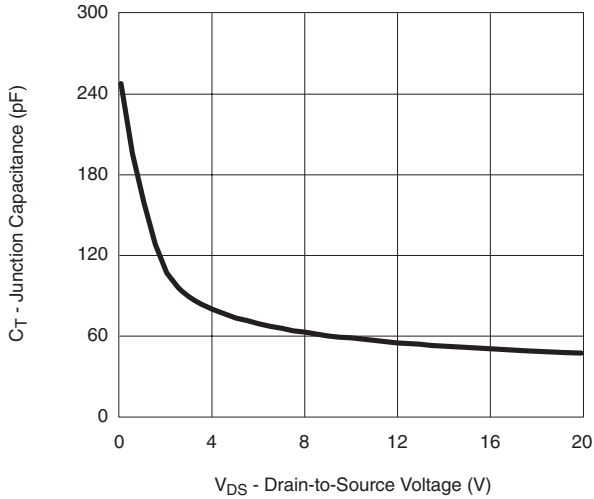

Capacitance

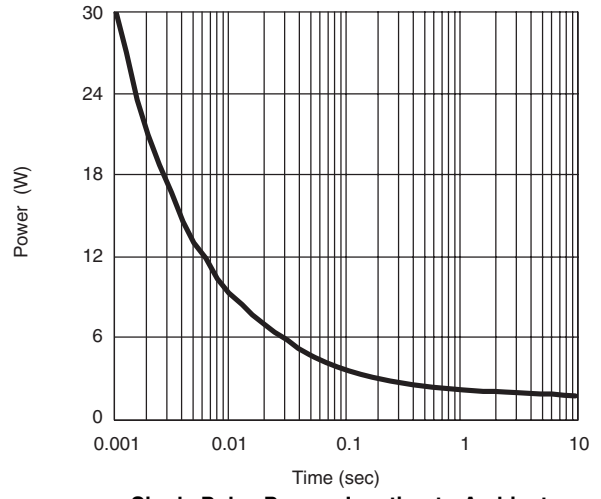

Single Pulse Power, Junction-to-Ambient



SCHOTTKY TYPICAL CHARACTERISTICS $T_A = 25\text{ }^\circ\text{C}$, unless otherwise noted

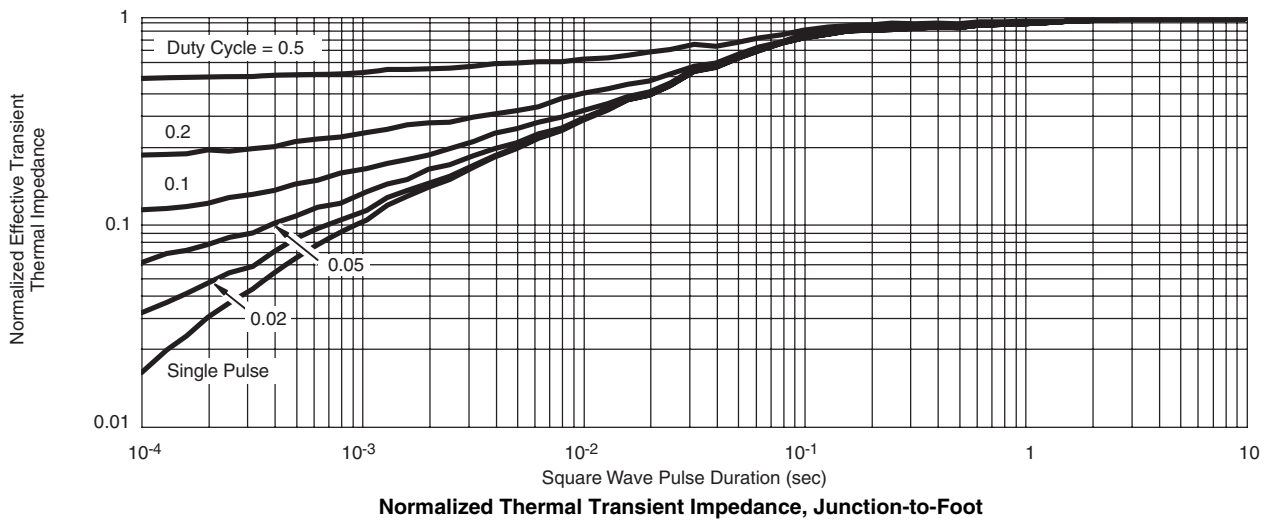
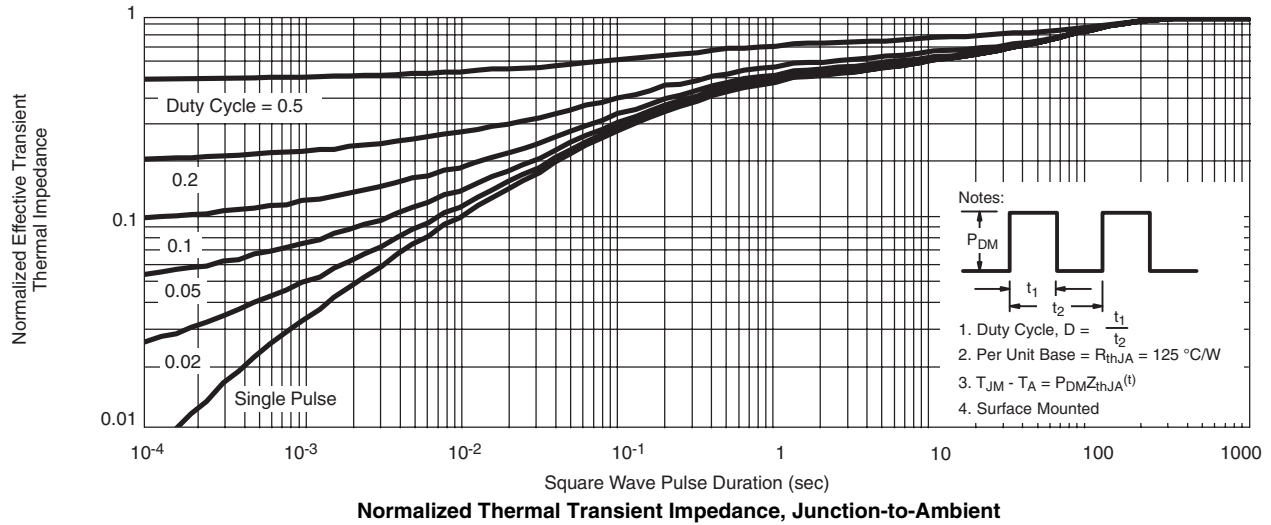

Vishay Siliconix maintains worldwide manufacturing capability. Products may be manufactured at one of several qualified locations. Reliability data for Silicon Technology and Package Reliability represent a composite of all qualified locations. For related documents such as package/tape drawings, part marking, and reliability data, see <http://www.vishay.com/ppg?74958>.



Notice

Specifications of the products displayed herein are subject to change without notice. Vishay Intertechnology, Inc., or anyone on its behalf, assumes no responsibility or liability for any errors or inaccuracies.

Information contained herein is intended to provide a product description only. No license, express or implied, by estoppel or otherwise, to any intellectual property rights is granted by this document. Except as provided in Vishay's terms and conditions of sale for such products, Vishay assumes no liability whatsoever, and disclaims any express or implied warranty, relating to sale and/or use of Vishay products including liability or warranties relating to fitness for a particular purpose, merchantability, or infringement of any patent, copyright, or other intellectual property right.

The products shown herein are not designed for use in medical, life-saving, or life-sustaining applications. Customers using or selling these products for use in such applications do so at their own risk and agree to fully indemnify Vishay for any damages resulting from such improper use or sale.