



## P-Channel 20-V (D-S) MOSFET

| PRODUCT SUMMARY |                           |           |
|-----------------|---------------------------|-----------|
| $V_{DS}$ (V)    | $r_{DS(on)}$ ( $\Omega$ ) | $I_D$ (A) |
| -20             | 0.019 @ $V_{GS} = -4.5$ V | -11.4     |
|                 | 0.025 @ $V_{GS} = -2.5$ V | -9.9      |
|                 | 0.034 @ $V_{GS} = -1.8$ V | -8.5      |

### FEATURES

- TrenchFET® Power MOSFET: 1.8-V Rated
- New PowerPAK® Package
  - Low Thermal Resistance,  $R_{thJC}$
  - Low 1.07-mm Profile



**RoHS**  
COMPLIANT

### APPLICATIONS

- Load Switch

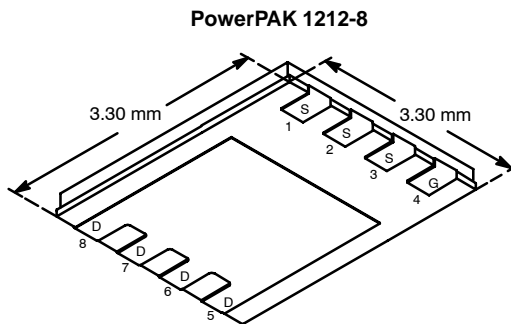

Bottom View

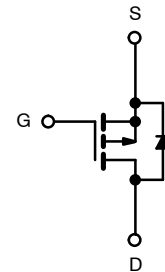

P-Channel MOSFET

Ordering Information: Si7411DN-T1—E3 (Lead (Pb)-Free)

| ABSOLUTE MAXIMUM RATINGS ( $T_A = 25^\circ\text{C}$ UNLESS OTHERWISE NOTED) |                          |                |            |              |                  |
|---|--------------------------|----------------|------------|--------------|------------------|
| Parameter   |                          | Symbol         | 10 secs    | Steady State | Unit             |
| Drain-Source Voltage  |                          | $V_{DS}$       | -20        |              | V                |
| Gate-Source Voltage   |                          | $V_{GS}$       | $\pm 8$    |              |                  |
| Continuous Drain Current ( $T_J = 150^\circ\text{C}$ ) <sup>a</sup>         | $T_A = 25^\circ\text{C}$ | $I_D$          | -11.4      | -7.5         | A                |
|   | $T_A = 85^\circ\text{C}$ |                | -8.2       | -5.4         |                  |
| Pulsed Drain Current  |                          | $I_{DM}$       | -30        |              |                  |
| continuous Source Current (Diode Conduction) <sup>a</sup>                   |                          | $I_S$          | -3         | -1.3         |                  |
| Maximum Power Dissipation <sup>a</sup>                                      | $T_A = 25^\circ\text{C}$ | $P_D$          | 3.6        | 1.5          | W                |
|   | $T_A = 85^\circ\text{C}$ |                | 1.9        | 0.8          |                  |
| Operating Junction and Storage Temperature Range                            |                          | $T_J, T_{stg}$ | -55 to 150 |              | $^\circ\text{C}$ |
| Soldering Recommendations (Peak Temperature) <sup>b,c</sup>                 |                          |                | 260        |              |                  |

| THERMAL RESISTANCE RATINGS               |                 |            |         |         |                           |
|--|-----------------|------------|---------|---------|---------------------------|
| Parameter                                |                 | Symbol     | Typical | Maximum | Unit                      |
| Maximum Junction-to-Ambient <sup>a</sup> | $t \leq 10$ sec | $R_{thJA}$ | 28      | 35      | $^\circ\text{C}/\text{W}$ |
|  | Steady State    |            | 65      | 81      |                           |
| Maximum Junction-to-Case                 |                 | $R_{thJC}$ | 2.9     | 3.8     |                           |

**Notes**

- Surface Mounted on 1" x 1" FR4 Board.
- See Solder Profile (<http://www.vishay.com/doc?73257>). The PowerPAK 1212-8 is a leadless package. The end of the lead terminal is exposed copper (not plated) as a result of the singulation process in manufacturing. A solder fillet at the exposed copper tip cannot be guaranteed and is not required to ensure adequate bottom side solder interconnection.
- Rework Conditions: manual soldering with a soldering iron is not recommended for leadless components.

**SPECIFICATIONS (T<sub>J</sub> = 25 °C UNLESS OTHERWISE NOTED)**

| Parameter                                     | Symbol              | Test Condition   | Min                                       | Typ   | Max   | Unit |
|---|---------------------|--|---|-------|-------|------|
| <b>Static</b>                                 |                     |  |   |       |       |      |
| Gate Threshold Voltage                        | V <sub>GS(th)</sub> | V <sub>DS</sub> = V <sub>GS</sub> , I <sub>D</sub> = -300 μA   | -0.4                                      |       | -1.0  | V    |
| Gate-Body Leakage                             | I <sub>GSS</sub>    | V <sub>DS</sub> = 0 V, V <sub>GS</sub> = ±8 V  |   |       | ±100  | nA   |
| Zero Gate Voltage Drain Current               | I <sub>DSS</sub>    | V <sub>DS</sub> = -20 V, V <sub>GS</sub> = 0 V   |   |       | -1    | μA   |
|   |                     | V <sub>DS</sub> = -20 V, V <sub>GS</sub> = 0 V, T <sub>J</sub> = 85 °C   |   |       | -5    |      |
| On-State Drain Current <sup>a</sup>           | I <sub>D(on)</sub>  | V <sub>DS</sub> ≤ -5 V, V <sub>GS</sub> = -4.5 V   | -30                                       |       |       | A    |
| Drain-Source On-State Resistance <sup>a</sup> | r <sub>DS(on)</sub> | V <sub>GS</sub> = -4.5 V, I <sub>D</sub> = -11.4 A   |   | 0.015 | 0.019 | Ω    |
|   |                     | V <sub>GS</sub> = -2.5 V, I <sub>D</sub> = -9.9 A  |   | 0.020 | 0.025 |      |
|   |                     | V <sub>GS</sub> = -1.8 V, I <sub>D</sub> = -2.9 A  |   | 0.027 | 0.034 |      |
| Forward Transconductance <sup>a</sup>         | g <sub>fs</sub>     | V <sub>DS</sub> = -15 V, I <sub>D</sub> = -11.4 A  |   | 35    |       | S    |
| Diode Forward Voltage <sup>a</sup>            | V <sub>SD</sub>     | I <sub>S</sub> = -3.0 A, V <sub>GS</sub> = 0 V   |   | -0.8  | -1.2  | V    |
| <b>Dynamic<sup>b</sup></b>                    |                     |  |   |       |       |      |
| Total Gate Charge                             | Q <sub>g</sub>      | V <sub>DS</sub> = -10 V, V <sub>GS</sub> = -4.5 V, I <sub>D</sub> = -11.4 A  |   | 27    | 41    | nC   |
| Gate-Source Charge                            | Q <sub>gs</sub>     |  |   | 3.9   |       |      |
| Gate-Drain Charge                             | Q <sub>gd</sub>     |  |   | 7     |       |      |
| Gate Resistance                               | R <sub>g</sub>      | f = 1 MHz  |   | 5     |       | Ω    |
| Turn-On Delay Time                            | t <sub>d(on)</sub>  | V <sub>DD</sub> = -10 V, R <sub>L</sub> = 10 Ω<br>I <sub>D</sub> ≅ -1 A, V <sub>GEN</sub> = -4.5 V, R <sub>g</sub> = 6 Ω |   | 23    | 35    | ns   |
| Rise Time                                     | t <sub>r</sub>      |  |   | 45    | 70    |      |
| Turn-Off Delay Time                           | t <sub>d(off)</sub> |  |   | 135   | 200   |      |
| Fall Time                                     | t <sub>f</sub>      |  |   | 70    | 105   |      |
| Source-Drain Reverse Recovery Time            | t <sub>rr</sub>     |  | I <sub>F</sub> = -3.2 A, di/dt = 100 A/μs |       | 29    |      |

## Notes

- a. Pulse test; pulse width ≤ 300 μs, duty cycle ≤ 2%.  
b. Guaranteed by design, not subject to production testing.

Stresses beyond those listed under "Absolute Maximum Ratings" may cause permanent damage to the device. These are stress ratings only, and functional operation of the device at these or any other conditions beyond those indicated in the operational sections of the specifications is not implied. Exposure to absolute maximum rating conditions for extended periods may affect device reliability.

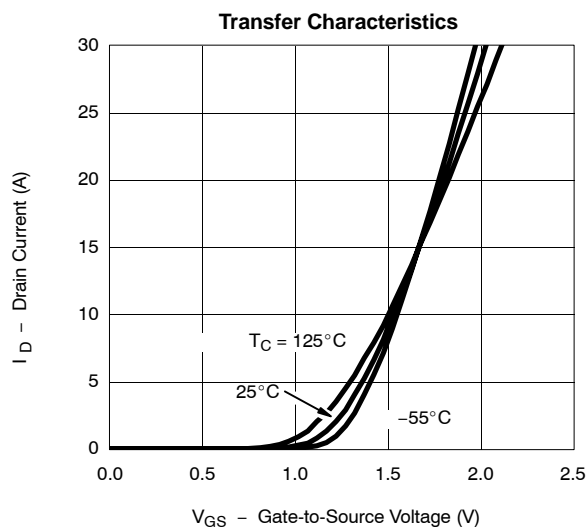
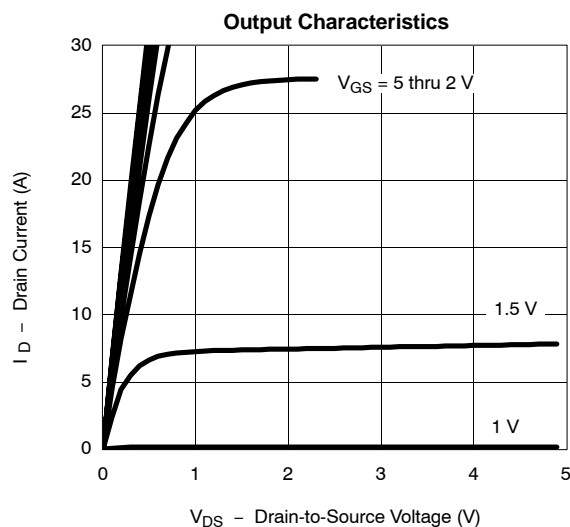
**TYPICAL CHARACTERISTICS (25 °C UNLESS NOTED)**



**TYPICAL CHARACTERISTICS (25°C UNLESS NOTED)**

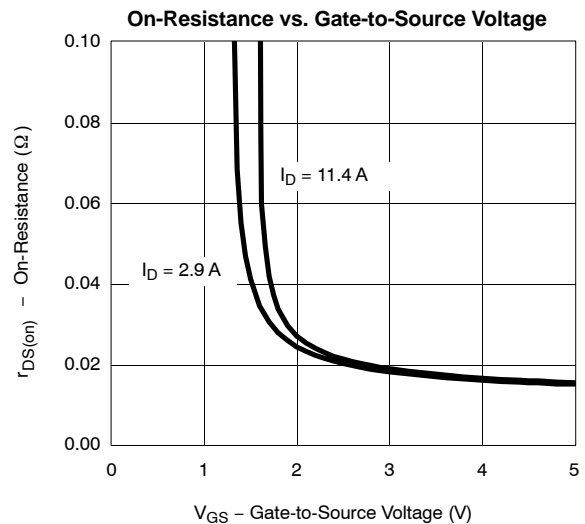
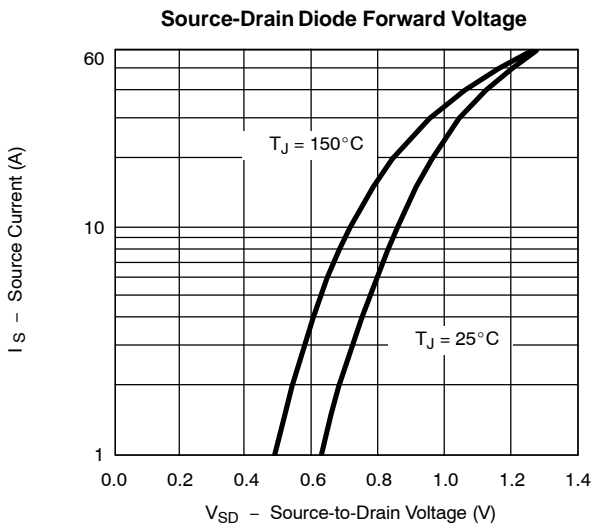
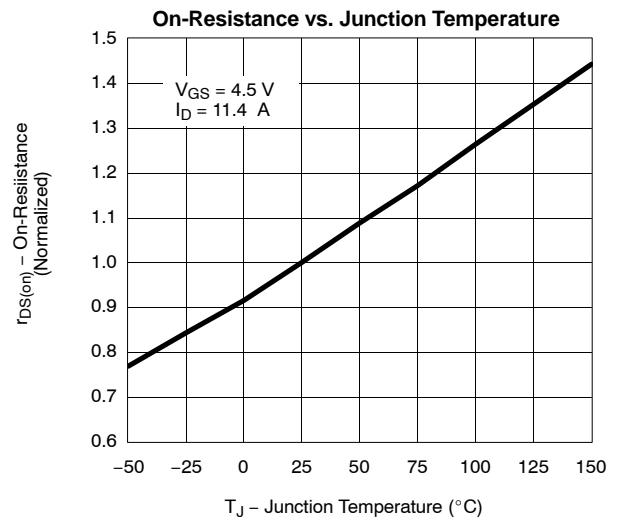
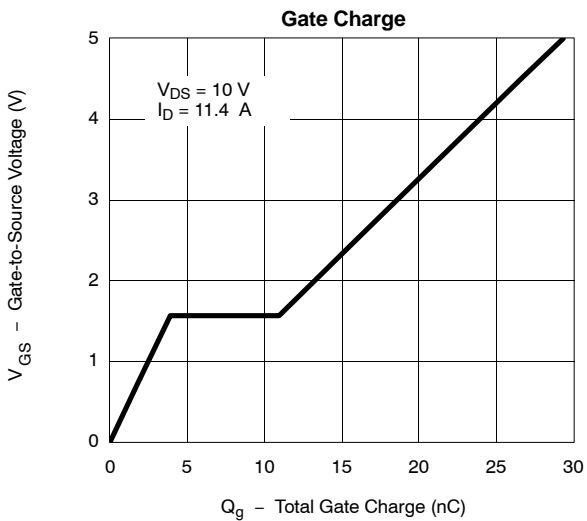
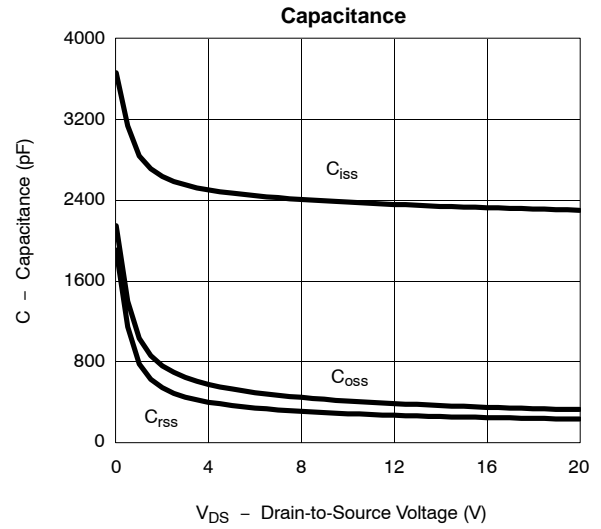
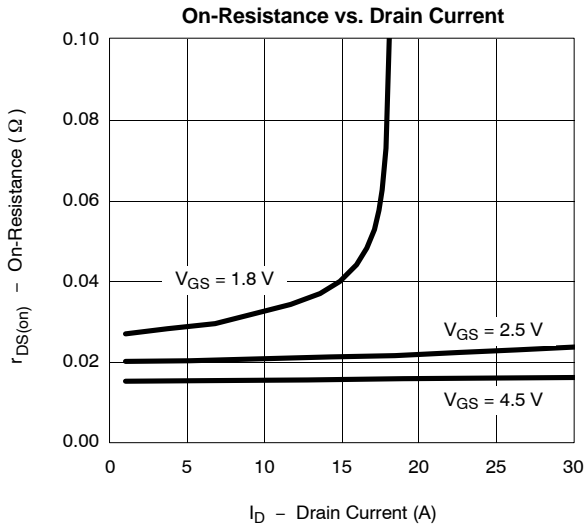

**TYPICAL CHARACTERISTICS (25 °C UNLESS NOTED)**

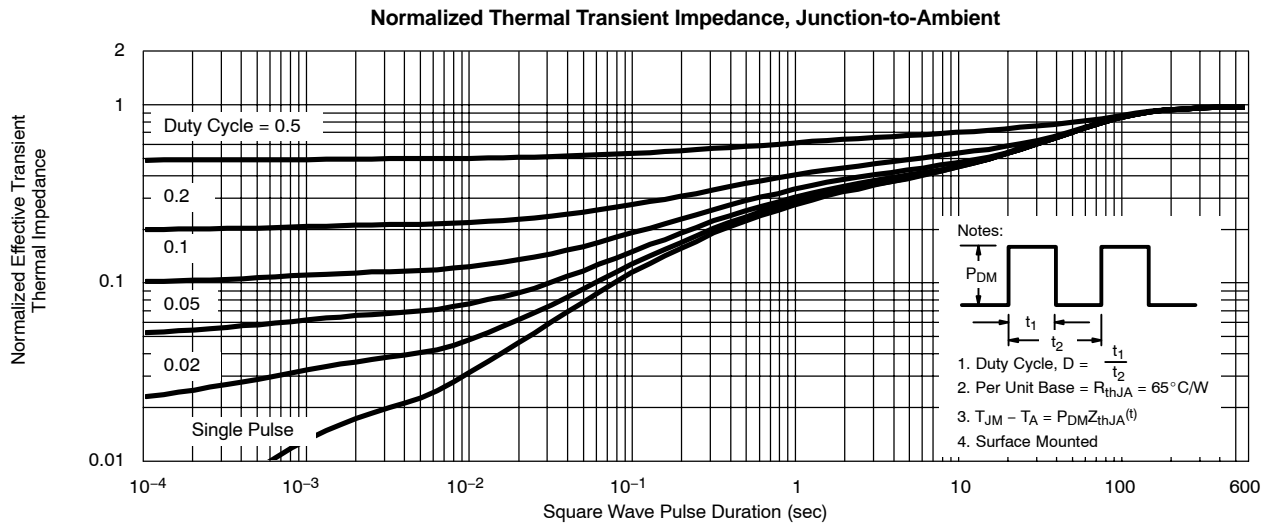
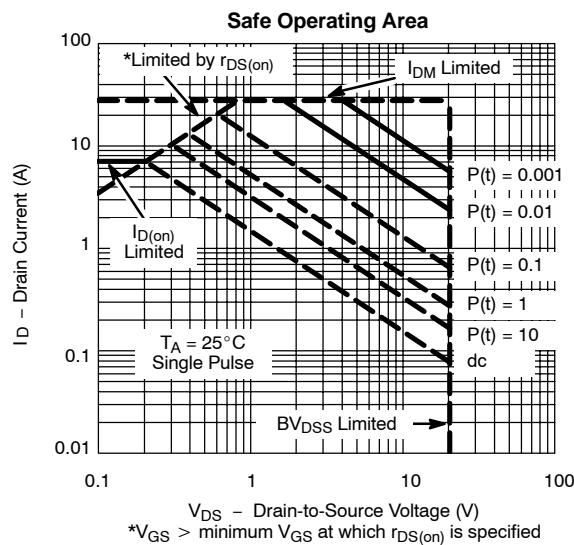
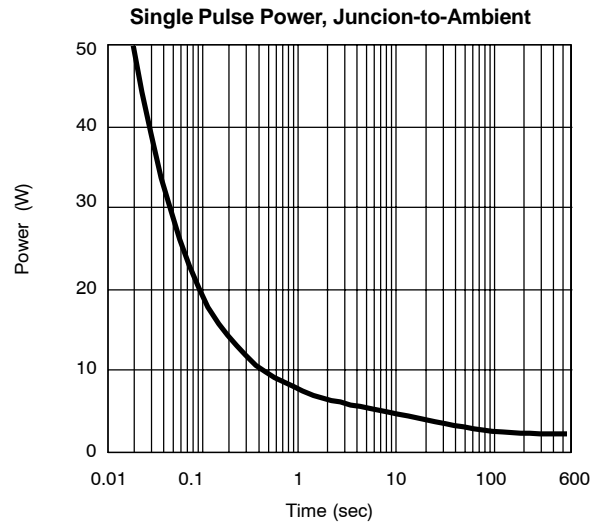
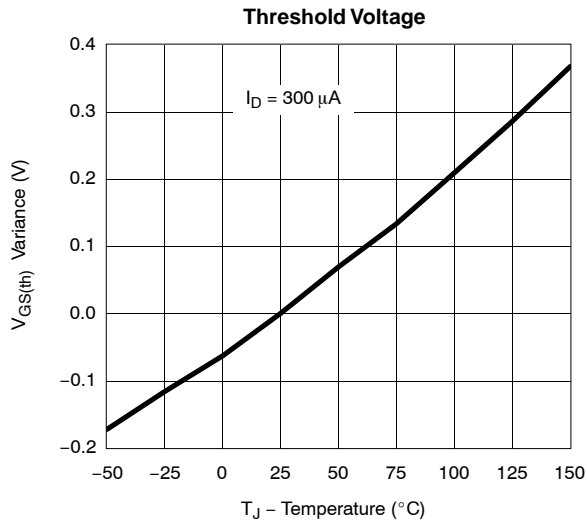



**TYPICAL CHARACTERISTICS (25 °C UNLESS NOTED)**

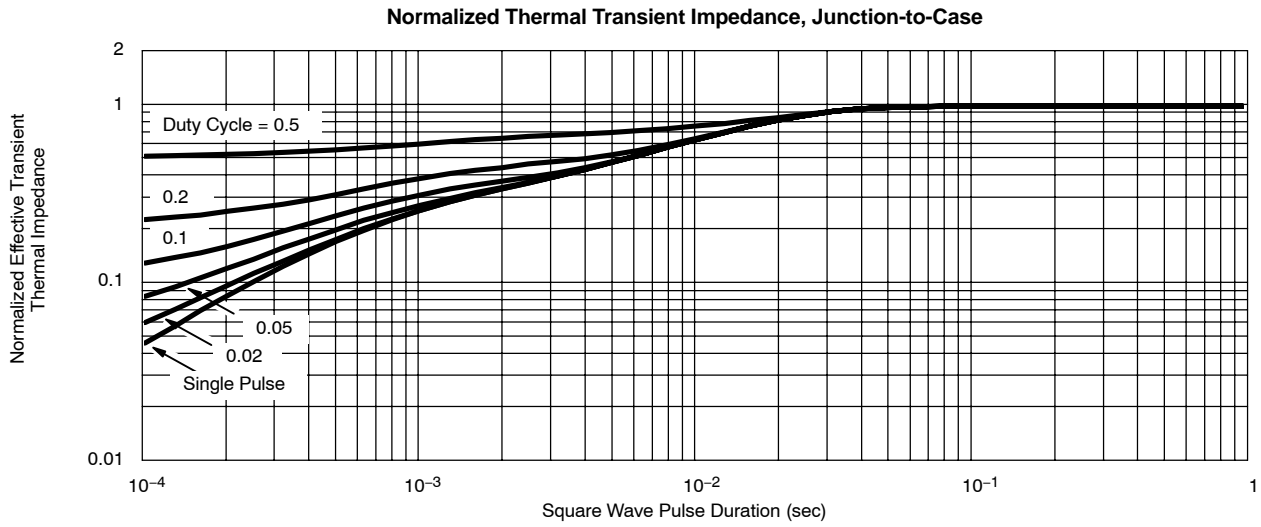

Vishay Siliconix maintains worldwide manufacturing capability. Products may be manufactured at one of several qualified locations. Reliability data for Silicon Technology and Package Reliability represent a composite of all qualified locations. For related documents such as package/tape drawings, part marking, and reliability data, see <http://www.vishay.com/ppg?72399>.



## Notice

Specifications of the products displayed herein are subject to change without notice. Vishay Intertechnology, Inc., or anyone on its behalf, assumes no responsibility or liability for any errors or inaccuracies.

Information contained herein is intended to provide a product description only. No license, express or implied, by estoppel or otherwise, to any intellectual property rights is granted by this document. Except as provided in Vishay's terms and conditions of sale for such products, Vishay assumes no liability whatsoever, and disclaims any express or implied warranty, relating to sale and/or use of Vishay products including liability or warranties relating to fitness for a particular purpose, merchantability, or infringement of any patent, copyright, or other intellectual property right.

The products shown herein are not designed for use in medical, life-saving, or life-sustaining applications. Customers using or selling these products for use in such applications do so at their own risk and agree to fully indemnify Vishay for any damages resulting from such improper use or sale.