

N-Channel 12-V (D-S) MOSFET

PRODUCT SUMMARY			
V _{DS} (V)	R _{DS(on)} (Ω)	I _D (A)	Q _g (Typ.)
12	0.0026 at V _{GS} = 4.5 V	29	54
	0.0037 at V _{GS} = 2.5 V	23	

FEATURES

- Halogen-free available
- TrenchFET® Power MOSFET
- New Low Thermal Resistance PowerPAK® Package with Low 1.07 mm Profile
- 100 % R_g Tested



RoHS
COMPLIANT

APPLICATIONS

- Low Output Voltage, High Current Synchronous Rectifiers

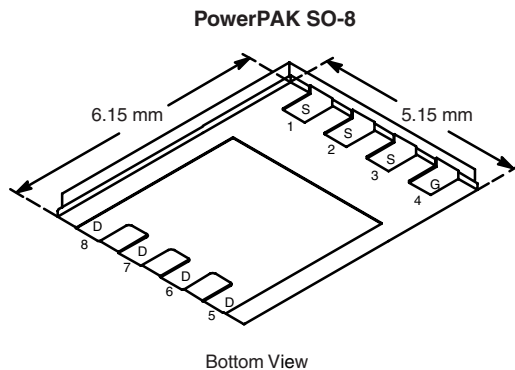

Ordering Information: Si7858ADP-T1-E3 (Lead (Pb)-free)
Si7858ADP-T1-GE3 (Lead (Pb)-free and Halogen-free)

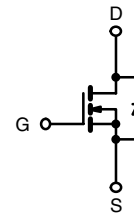

N-Channel MOSFET

ABSOLUTE MAXIMUM RATINGS T _A = 25 °C, unless otherwise noted					
Parameter	Symbol	10 s	Steady State	Unit	
Drain-Source Voltage	V _{DS}	12		V	
Gate-Source Voltage	V _{GS}	± 8			
Continuous Drain Current (T _J = 150 °C) ^a	I _D	T _A = 25 °C	29	20	A
		T _A = 70 °C	23	16	
Pulsed Drain Current (10 μs Pulse Width)	I _{DM}	60		A	
Continuous Source Current (Diode Conduction) ^a	I _S	4.5	1.6		
Maximum Power Dissipation ^a	P _D	T _A = 25 °C	5.4	1.9	W
		T _A = 70 °C	3.4	1.2	
Operating Junction and Storage Temperature Range	T _J , T _{stg}	- 55 to 150		°C	
Soldering Recommendations (Peak Temperature) ^{b,c}		260			

THERMAL RESISTANCE RATINGS					
Parameter		Symbol	Typical	Maximum	Unit
Maximum Junction-to-Ambient ^a	t ≤ 10 s	R _{thJA}	18	23	°C/W
	Steady State		50	65	
Maximum Junction-to-Case (Drain)	Steady State	R _{thJC}	1.0	1.5	

Notes:

- Surface Mounted on 1" x 1" FR4 board.
- See Solder Profile (<http://www.vishay.com/ppg?73257>). The PowerPAK SO-8 is a leadless package. The end of the lead terminal is exposed copper (not plated) as a result of the singulation process in manufacturing. A solder fillet at the exposed copper tip cannot be guaranteed and is not required to ensure adequate bottom side solder interconnection.
- Rework Conditions: manual soldering with a soldering iron is not recommended for leadless components.

SPECIFICATIONS $T_J = 25\text{ }^\circ\text{C}$, unless otherwise noted						
Parameter	Symbol	Test Conditions	Min.	Typ.	Max.	Unit
Static						
Gate Threshold Voltage	$V_{GS(th)}$	$V_{DS} = V_{GS}, I_D = 250\text{ }\mu\text{A}$	0.6	0.95	1.5	V
Gate-Body Leakage	I_{GSS}	$V_{DS} = 0\text{ V}, V_{GS} = \pm 8\text{ V}$			± 100	nA
Zero Gate Voltage Drain Current	I_{DSS}	$V_{DS} = 12\text{ V}, V_{GS} = 0\text{ V}$			1	μA
		$V_{DS} = 12\text{ V}, V_{GS} = 0\text{ V}, T_J = 55\text{ }^\circ\text{C}$			10	
On-State Drain Current ^a	$I_{D(on)}$	$V_{DS} \geq 5\text{ V}, V_{GS} = 4.5\text{ V}$	30			A
Drain-Source On-State Resistance ^a	$R_{DS(on)}$	$V_{GS} = 4.5\text{ V}, I_D = 29\text{ A}$		0.0020	0.0026	Ω
		$V_{GS} = 2.5\text{ V}, I_D = 23\text{ A}$		0.0029	0.0037	
Forward Transconductance ^a	g_{fs}	$V_{DS} = 6\text{ V}, I_D = 29\text{ A}$		130		S
Diode Forward Voltage ^a	V_{SD}	$I_S = 2.9\text{ A}, V_{GS} = 0\text{ V}$		0.75	1.1	V
Dynamic^b						
Input Capacitance	C_{iss}	$V_{DS} = 6\text{ V}, V_{SS} = 0\text{ V}, f = 1\text{ MHz}$		5700		μF
Output Capacitance	C_{oss}			2680		
Reverse Transfer Capacitance	C_{rss}			1280		
Total Gate Charge	Q_g	$V_{DS} = 6\text{ V}, V_{GS} = 4.5\text{ V}, I_D = 29\text{ A}$		54	80	nC
Gate-Source Charge	Q_{gs}			10		
Gate-Drain Charge	Q_{gd}			16		
Gate Resistance	R_g		0.5	1.2	2.0	Ω
Turn-On Delay Time	$t_{d(on)}$	$V_{DD} = 6\text{ V}, R_L = 6\text{ }\Omega$ $I_D \cong 1\text{ A}, V_{GEN} = 4.5\text{ V}, R_G = 6\text{ }\Omega$		40	60	ns
Rise Time	t_r			40	60	
Turn-Off Delay Time	$t_{d(off)}$			140	210	
Fall Time	t_f			70	100	
Source-Drain Reverse Recovery Time	t_{rr}		$I_F = 2.9\text{ A}, di/dt = 100\text{ A}/\mu\text{s}$		50	

Notes:

a. Pulse test; pulse width $\leq 300\text{ }\mu\text{s}$, duty cycle $\leq 2\%$.

b. Guaranteed by design, not subject to production testing.

Stresses beyond those listed under "Absolute Maximum Ratings" may cause permanent damage to the device. These are stress ratings only, and functional operation of the device at these or any other conditions beyond those indicated in the operational sections of the specifications is not implied. Exposure to absolute maximum rating conditions for extended periods may affect device reliability.

TYPICAL CHARACTERISTICS $25\text{ }^\circ\text{C}$, unless otherwise noted

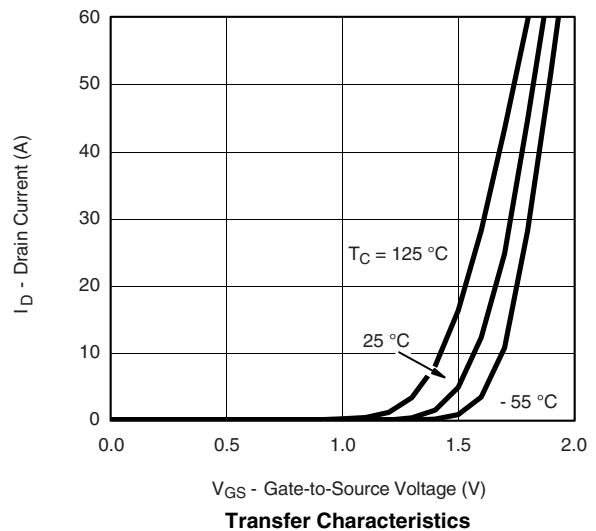
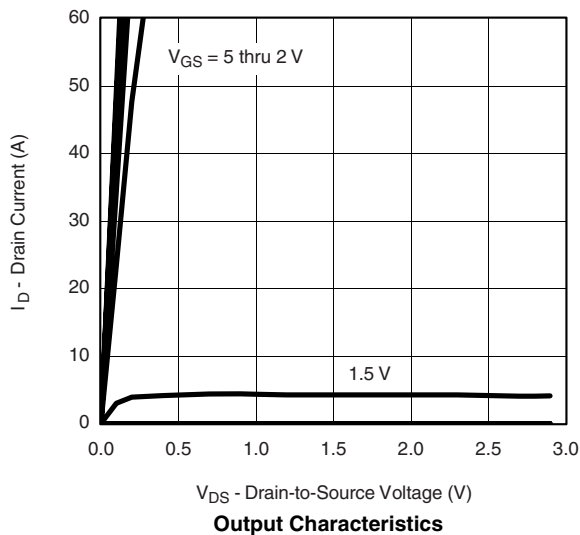

TYPICAL CHARACTERISTICS 25 °C, unless otherwise noted

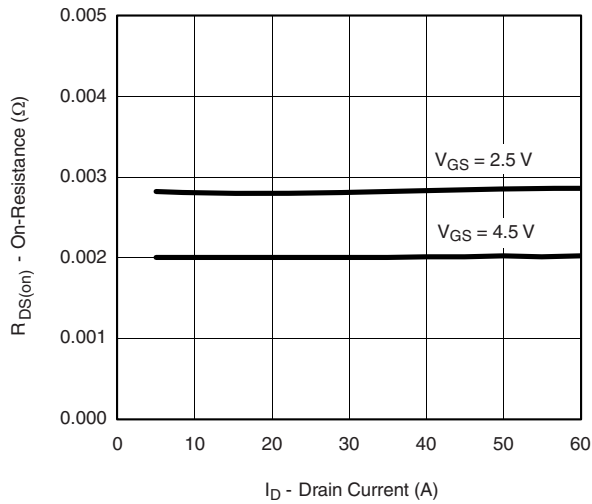

On-Resistance vs. Drain Current

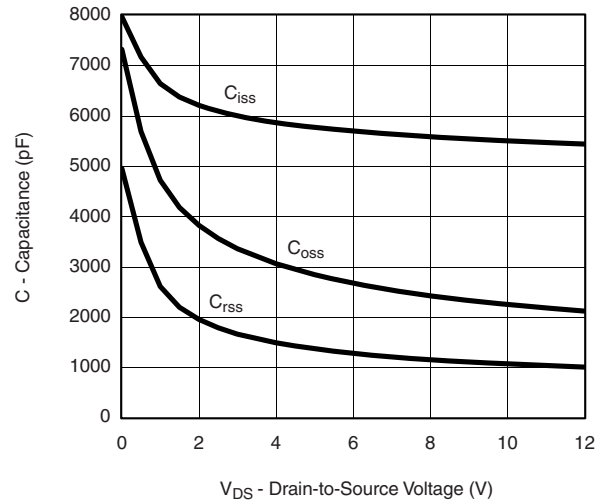

Capacitance

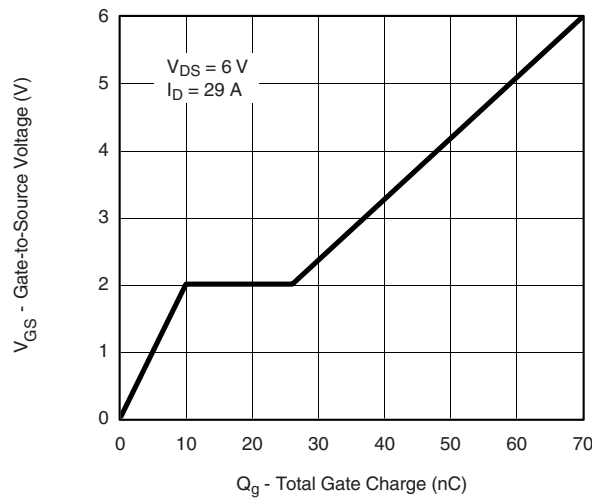

Gate Charge

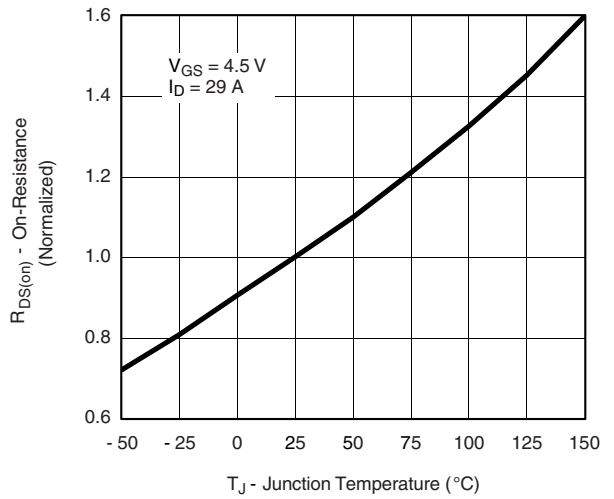

On-Resistance vs. Junction Temperature

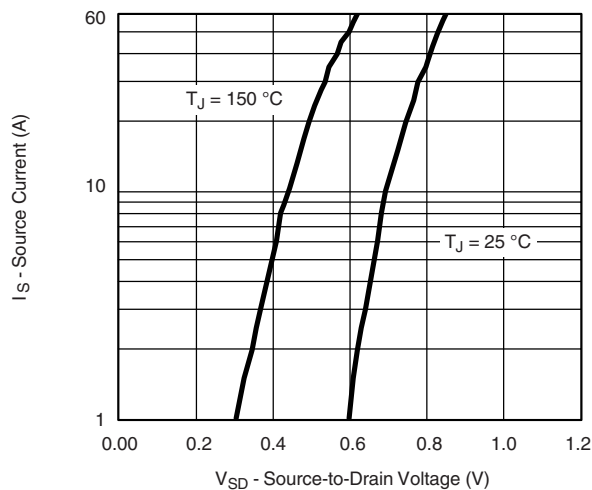

Source-Drain Diode Forward Voltage

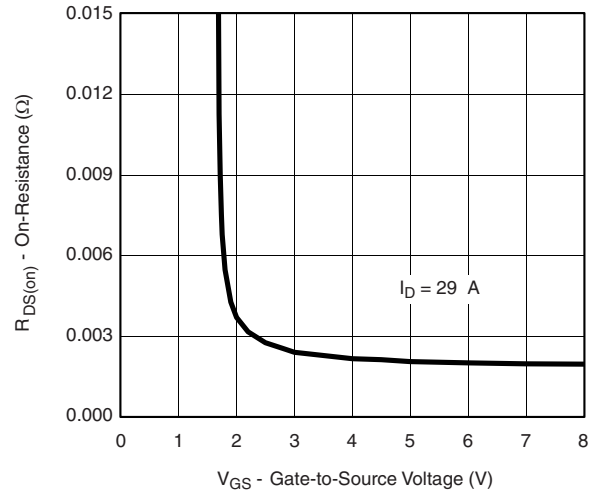

On-Resistance vs. Gate-to-Source Voltage

TYPICAL CHARACTERISTICS 25 °C, unless otherwise noted

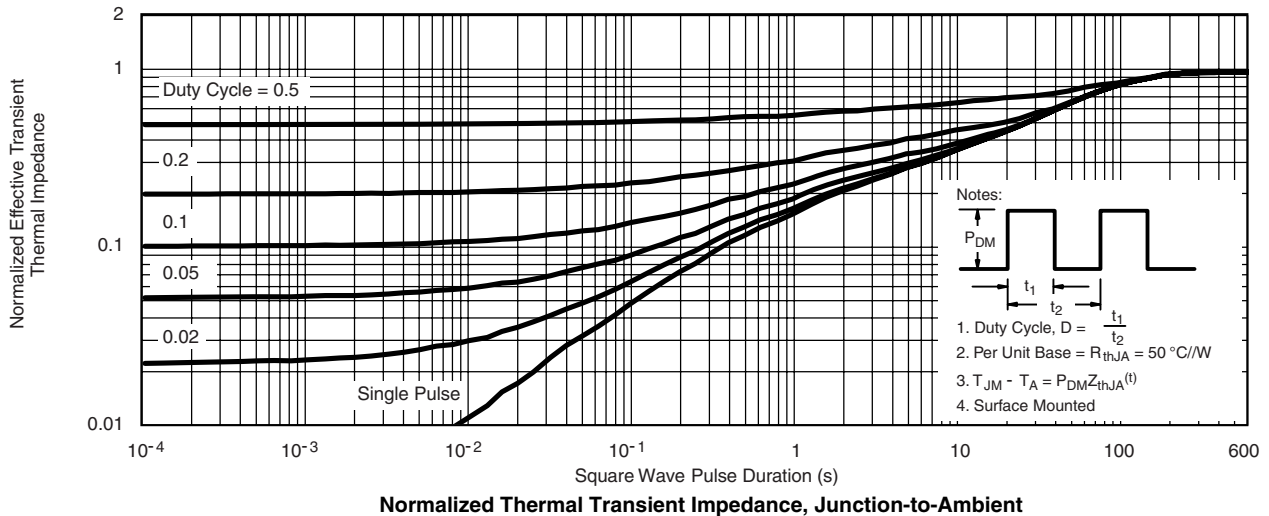
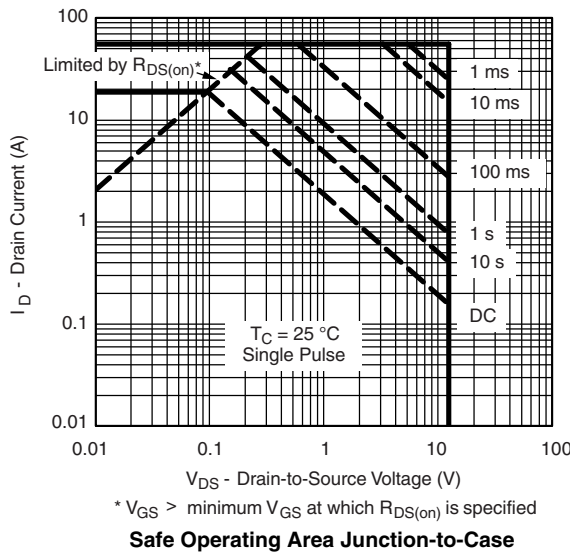
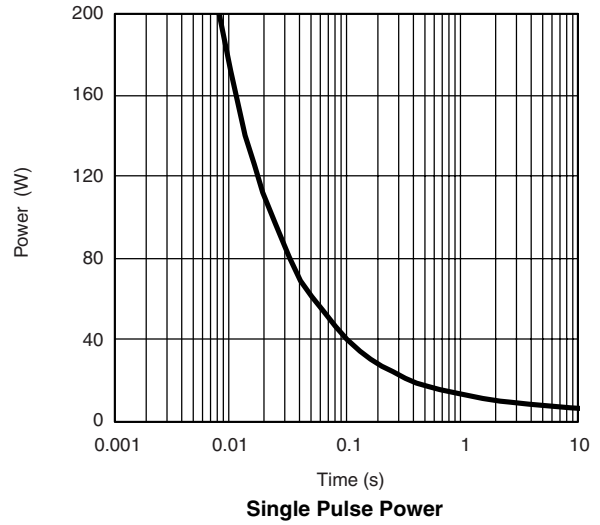
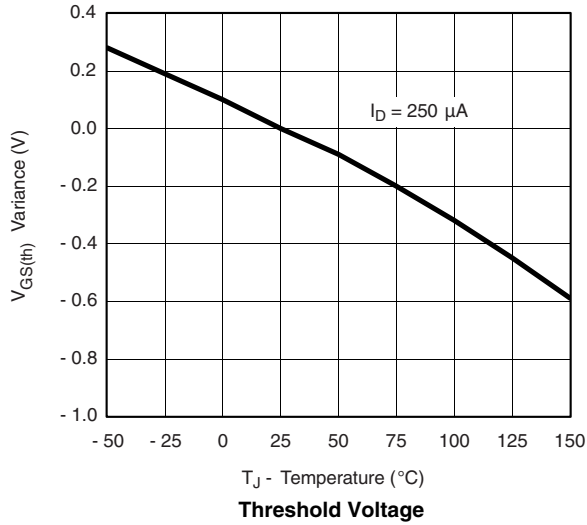

TYPICAL CHARACTERISTICS 25 °C, unless otherwise noted

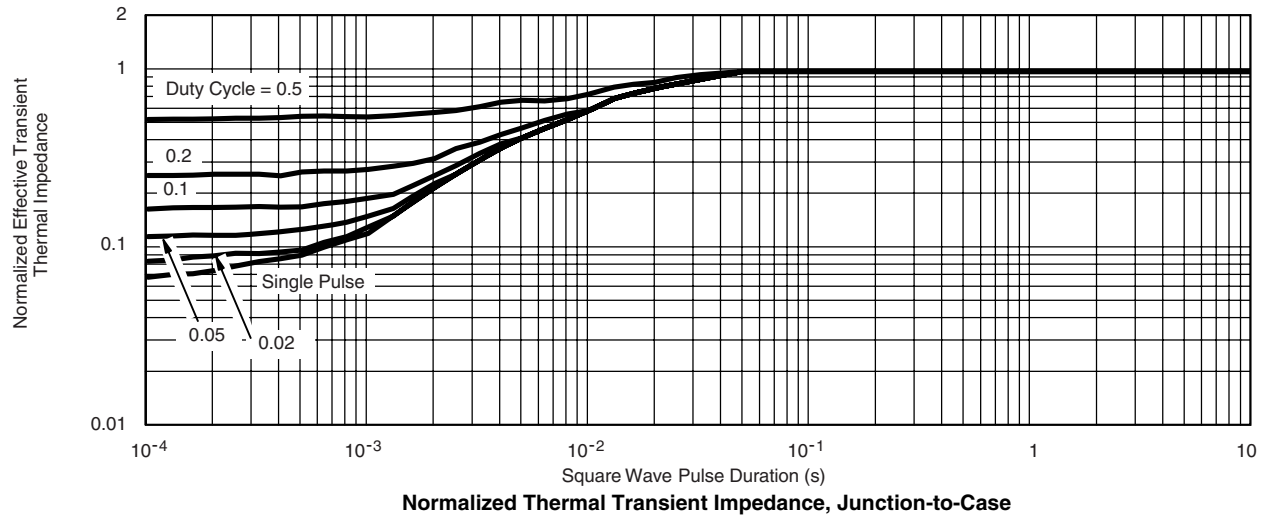

Vishay Siliconix maintains worldwide manufacturing capability. Products may be manufactured at one of several qualified locations. Reliability data for Silicon Technology and Package Reliability represent a composite of all qualified locations. For related documents such as package/tape drawings, part marking, and reliability data, see <http://www.vishay.com/ppg?73164>.



Notice

Specifications of the products displayed herein are subject to change without notice. Vishay Intertechnology, Inc., or anyone on its behalf, assumes no responsibility or liability for any errors or inaccuracies.

Information contained herein is intended to provide a product description only. No license, express or implied, by estoppel or otherwise, to any intellectual property rights is granted by this document. Except as provided in Vishay's terms and conditions of sale for such products, Vishay assumes no liability whatsoever, and disclaims any express or implied warranty, relating to sale and/or use of Vishay products including liability or warranties relating to fitness for a particular purpose, merchantability, or infringement of any patent, copyright, or other intellectual property right.

The products shown herein are not designed for use in medical, life-saving, or life-sustaining applications. Customers using or selling these products for use in such applications do so at their own risk and agree to fully indemnify Vishay for any damages resulting from such improper use or sale.