

Dual P-Channel 20-V (D-S) MOSFET

PRODUCT SUMMARY		
V_{DS} (V)	$r_{DS(on)}$ (Ω)	I_D (A)
- 20	0.051 at $V_{GS} = -4.5$ V	- 5.7
	0.067 at $V_{GS} = -2.5$ V	- 5.0
	0.094 at $V_{GS} = -1.8$ V	- 4.2

FEATURES

- TrenchFET[®] Power MOSFETS: 1.8-V Rated
- New Low Thermal Resistance PowerPAK[®] Package



RoHS*
COMPLIANT

APPLICATIONS

- Portable
 - PA Switch
 - Battery Switch
 - Load Switch

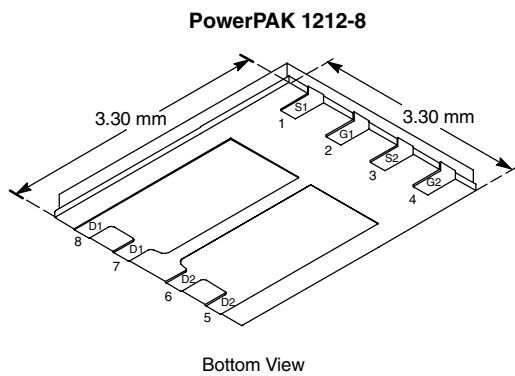

Bottom View

Ordering Information: Si7911DN-T1
Si7911DN-T1-E3 (Lead (Pb)-free)

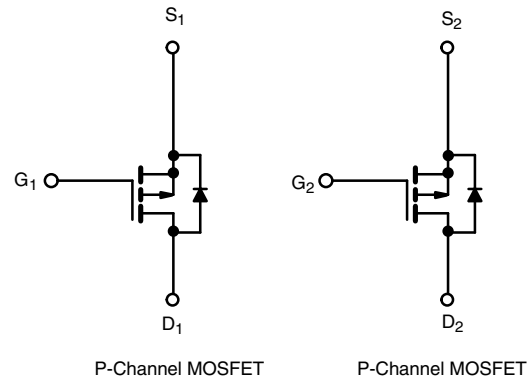

P-Channel MOSFET

P-Channel MOSFET

ABSOLUTE MAXIMUM RATINGS $T_A = 25$ °C, unless otherwise noted					
Parameter		Symbol	10 secs	Steady State	Unit
Drain-Source Voltage		V_{DS}	- 20		V
Gate-Source Voltage		V_{GS}	± 8		
Continuous Drain Current ($T_J = 150$ °C) ^a	$T_A = 25$ °C	I_D	- 5.7	- 4.2	A
	$T_A = 85$ °C		- 4.1	- 3.0	
Pulsed Drain Current		I_{DM}	- 20		A
Continuous Source Current (Diode Conduction) ^a		I_S	- 2.1	- 1.1	
Maximum Power Dissipation ^a	$T_A = 25$ °C	P_D	2.5	1.3	W
	$T_A = 85$ °C		1.3	0.85	
Operating Junction and Storage Temperature Range		T_J, T_{stg}	- 55 to 150		°C
Soldering Recommendations ^{b,c}			260		

THERMAL RESISTANCE RATINGS					
Parameter		Symbol	Typical	Maximum	Unit
Maximum Junction-to-Ambient ^a	$t \leq 10$ sec	R_{thJA}	40	50	°C/W
	Steady State		75	94	
Maximum Junction-to-Case	Steady State	R_{thJC}	5.6	7	

Notes

- a. Surface Mounted on 1" x 1" FR4 Board.
 b. See Solder Profile (<http://www.vishay.com/ppg?73257>). The PowerPAK 1212-8 is a leadless package. The end of the lead terminal is exposed copper (not plated) as a result of the singulation process in manufacturing. A solder fillet at the exposed copper tip cannot be guaranteed and is not required to ensure adequate bottom side solder interconnection.
 c. Rework Conditions: manual soldering with a soldering iron is not recommended for leadless components.

* Pb containing terminations are not RoHS compliant, exemptions may apply



SPECIFICATIONS $T_J = 25\text{ }^\circ\text{C}$, unless otherwise noted						
Parameter	Symbol	Test Condition	Min	Typ	Max	Unit
Static						
Gate Threshold Voltage	$V_{GS(th)}$	$V_{DS} = V_{GS}, I_D = -250\text{ }\mu\text{A}$	-0.40		-1.0	V
Gate-Body Leakage	I_{GSS}	$V_{DS} = 0\text{ V}, V_{GS} = \pm 8\text{ V}$			± 100	nA
Zero Gate Voltage Drain Current	I_{DSS}	$V_{DS} = -20\text{ V}, V_{GS} = 0\text{ V}$			-1	μA
		$V_{DS} = -20\text{ V}, V_{GS} = 0\text{ V}, T_J = 85\text{ }^\circ\text{C}$			-5	
On-State Drain Current ^a	$I_{D(on)}$	$V_{DS} \leq -5\text{ V}, V_{GS} = -4.5\text{ V}$	-20			A
Drain-Source On-State Resistance ^a	$r_{DS(on)}$	$V_{GS} = -4.5\text{ V}, I_D = -5.7\text{ A}$		0.040	0.051	Ω
		$V_{GS} = -2.5\text{ V}, I_D = -5.0\text{ A}$		0.054	0.067	
		$V_{GS} = -1.8\text{ V}, I_D = -1.1\text{ A}$		0.075	0.094	
Forward Transconductance ^a	g_{fs}	$V_{DS} = -6\text{ V}, I_D = -5.7\text{ A}$		14		S
Diode Forward Voltage ^a	V_{SD}	$I_S = -2.3\text{ A}, V_{GS} = 0\text{ V}$		-0.8	-1.2	V
Dynamic^b						
Total Gate Charge	Q_g	$V_{DS} = -6\text{ V}, V_{GS} = -4.5\text{ V}, I_D = -5.7\text{ A}$		9.5	15	nC
Gate-Source Charge	Q_{gs}		1.6			
Gate-Drain Charge	Q_{gd}		2.5			
Gate Resistance	R_g			7.2		Ω
Turn-On Delay Time	$t_{d(on)}$	$V_{DD} = -10\text{ V}, R_L = 10\text{ }\Omega$ $I_D = -1\text{ A}, V_{GEN} = -4.5\text{ V}, R_G = 6\text{ }\Omega$		20	30	ns
Rise Time	t_r		35	55		
Turn-Off Delay Time	$t_{d(off)}$		70	105		
Fall Time	t_f		40	60		
Source-Drain Reverse Recovery Time	t_{rr}		$I_F = -2.1\text{ A}, di/dt = 100\text{ A}/\mu\text{s}$		25	

Notes

- a. Pulse test; pulse width $\leq 300\text{ }\mu\text{s}$, duty cycle $\leq 2\%$.
- b. Guaranteed by design, not subject to production testing.

Stresses beyond those listed under "Absolute Maximum Ratings" may cause permanent damage to the device. These are stress ratings only, and functional operation of the device at these or any other conditions beyond those indicated in the operational sections of the specifications is not implied. Exposure to absolute maximum rating conditions for extended periods may affect device reliability.

TYPICAL CHARACTERISTICS $T_A = 25\text{ }^\circ\text{C}$, unless otherwise noted

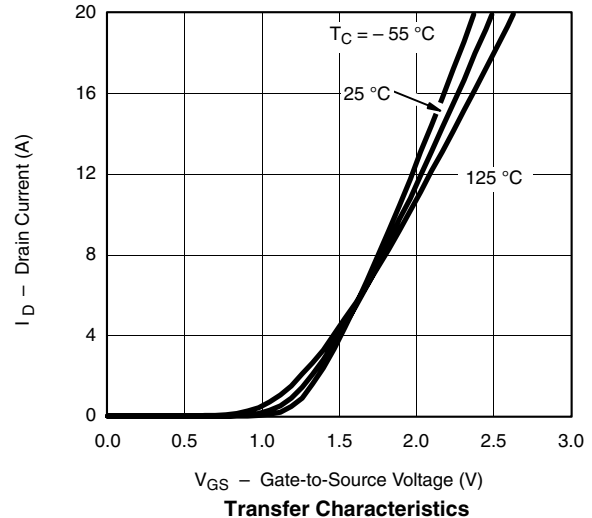
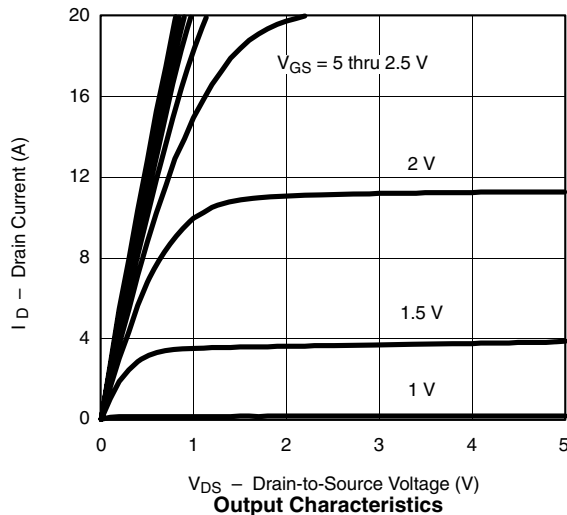

TYPICAL CHARACTERISTICS $T_A = 25\text{ }^\circ\text{C}$, unless otherwise noted

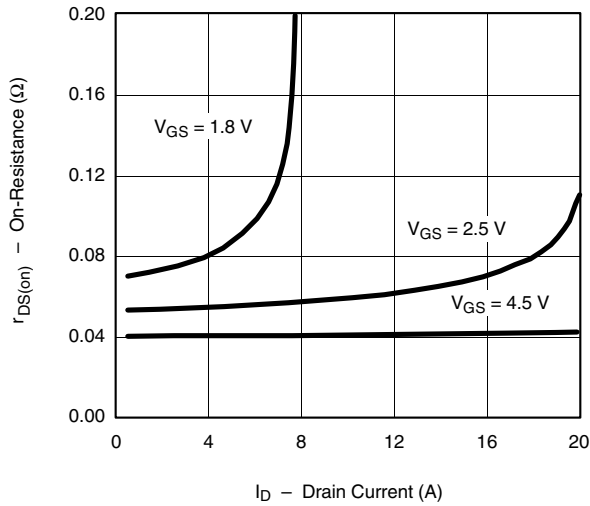

On-Resistance vs. Drain Current

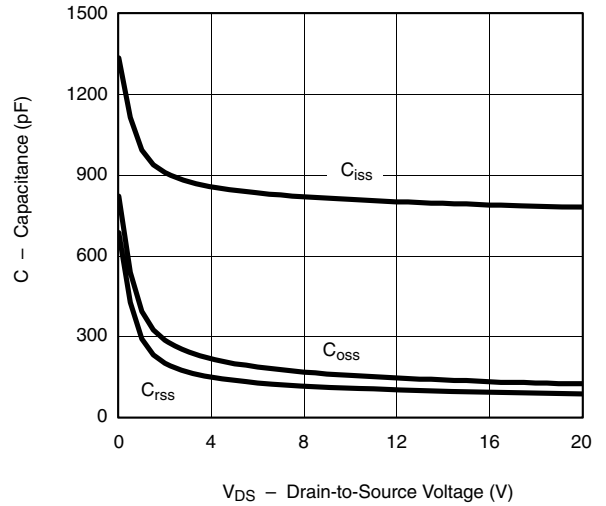

Capacitance

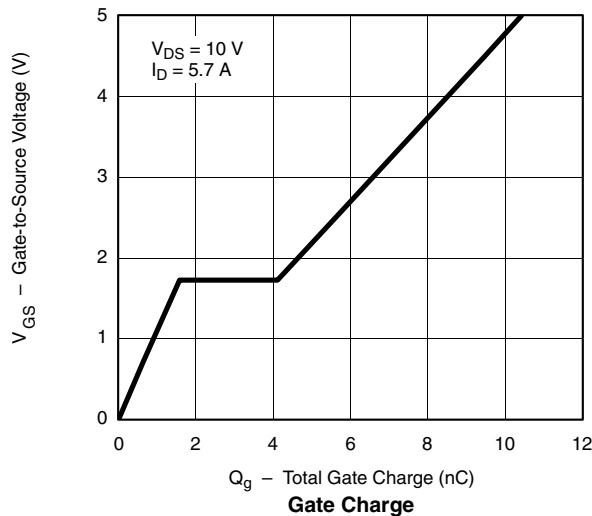

Gate Charge

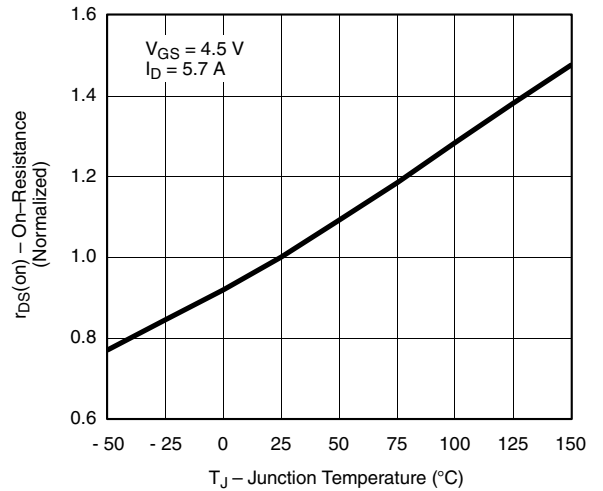

On-Resistance vs. Junction Temperature

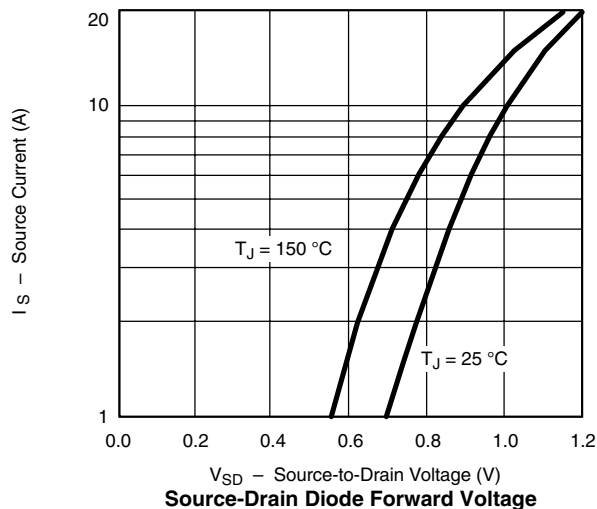

Source-Drain Diode Forward Voltage

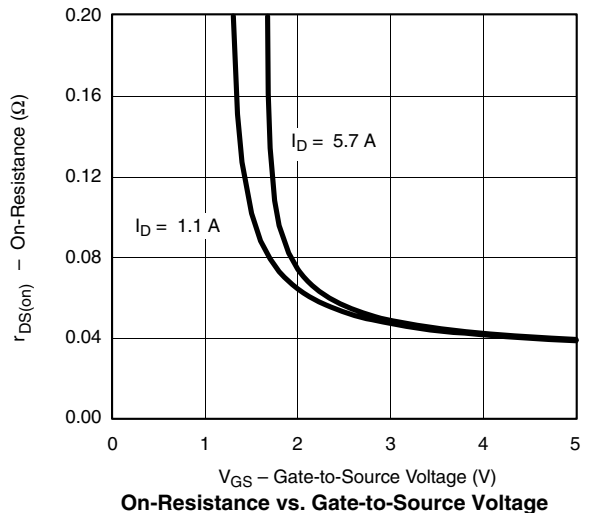

On-Resistance vs. Gate-to-Source Voltage



TYPICAL CHARACTERISTICS $T_A = 25\text{ }^\circ\text{C}$, unless otherwise noted

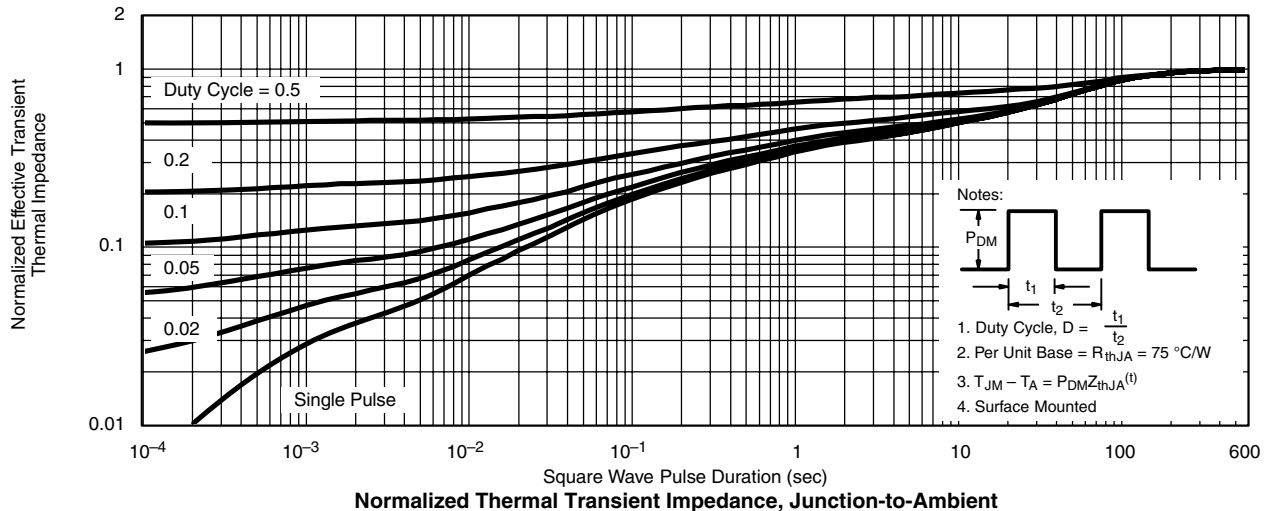
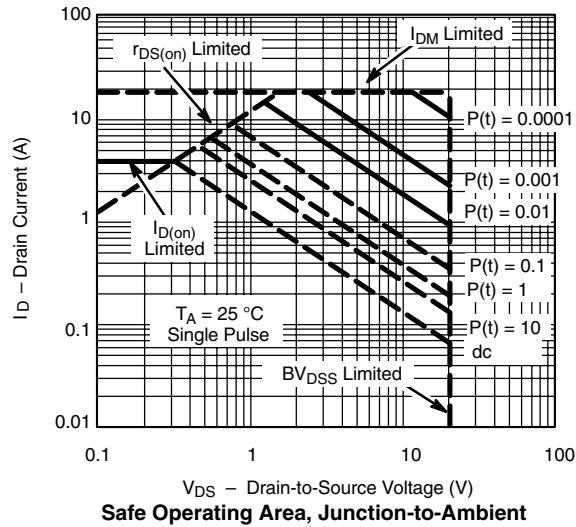
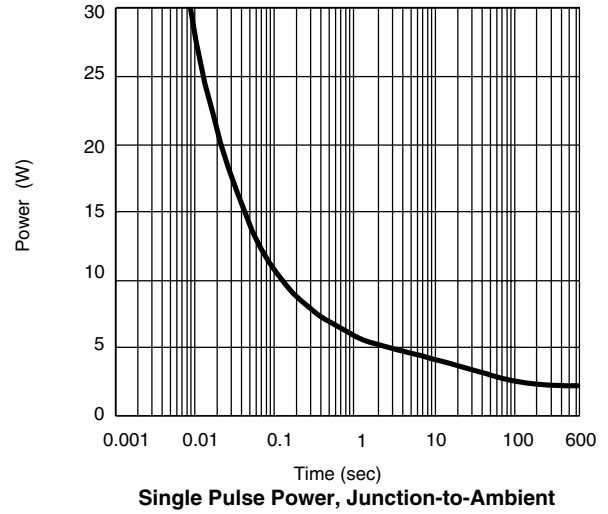
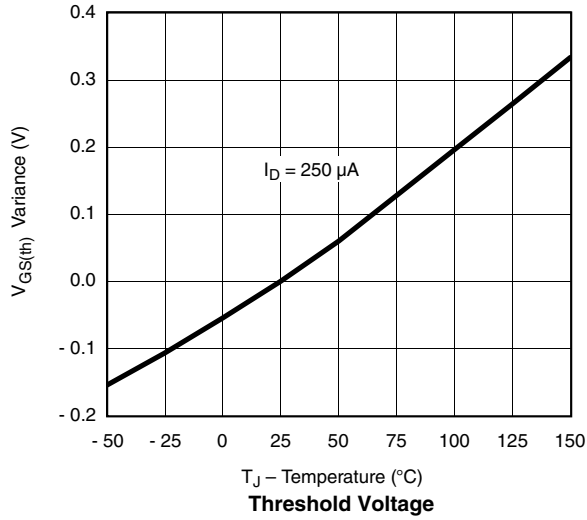



TYPICAL CHARACTERISTICS $T_A = 25\text{ }^\circ\text{C}$, unless otherwise noted

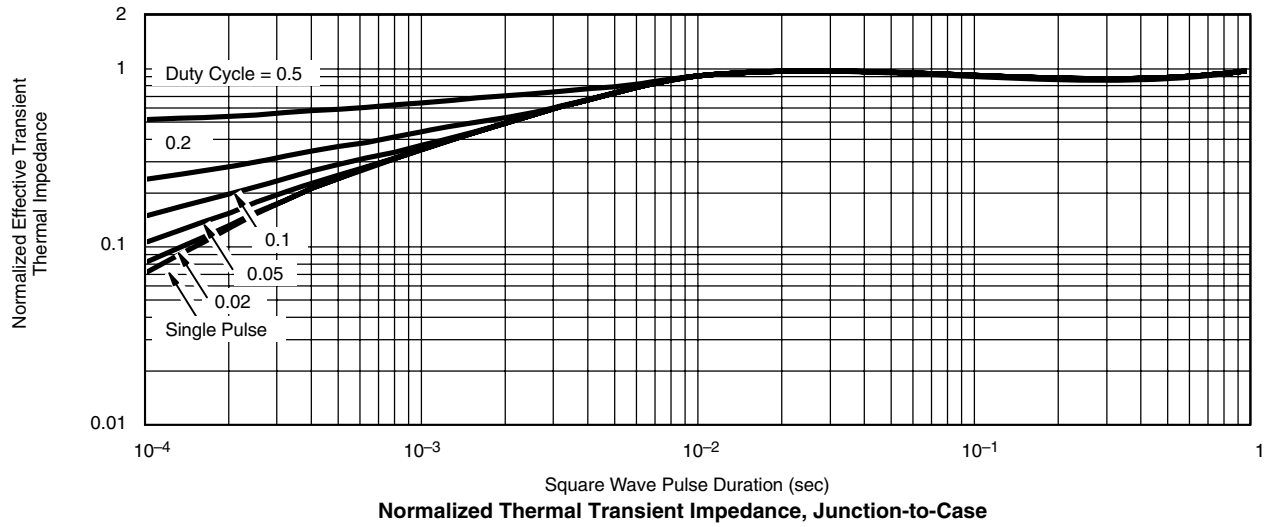

Vishay Siliconix maintains worldwide manufacturing capability. Products may be manufactured at one of several qualified locations. Reliability data for Silicon Technology and Package Reliability represent a composite of all qualified locations. For related documents such as package/tape drawings, part marking, and reliability data, see <http://www.vishay.com/ppg?72340>.



Notice

Specifications of the products displayed herein are subject to change without notice. Vishay Intertechnology, Inc., or anyone on its behalf, assumes no responsibility or liability for any errors or inaccuracies.

Information contained herein is intended to provide a product description only. No license, express or implied, by estoppel or otherwise, to any intellectual property rights is granted by this document. Except as provided in Vishay's terms and conditions of sale for such products, Vishay assumes no liability whatsoever, and disclaims any express or implied warranty, relating to sale and/or use of Vishay products including liability or warranties relating to fitness for a particular purpose, merchantability, or infringement of any patent, copyright, or other intellectual property right.

The products shown herein are not designed for use in medical, life-saving, or life-sustaining applications. Customers using or selling these products for use in such applications do so at their own risk and agree to fully indemnify Vishay for any damages resulting from such improper use or sale.