

## N-Channel 25-V (D-S) MOSFET

| PRODUCT SUMMARY     |                                   |                                 |                       |
|---------------------|-----------------------------------|---------------------------------|-----------------------|
| V <sub>DS</sub> (V) | R <sub>DS(on)</sub> (Ω)           | I <sub>D</sub> (A) <sup>a</sup> | Q <sub>g</sub> (Typ.) |
| 25                  | 0.00325 at V <sub>GS</sub> = 10 V | 40 <sup>g</sup>                 | 35.5 nC               |
|                     | 0.0040 at V <sub>GS</sub> = 4.5 V | 40 <sup>g</sup>                 |                       |

### FEATURES

- Halogen-free
- TrenchFET<sup>®</sup> Power MOSFET
- 100 % R<sub>g</sub> Tested
- 100 % Avalanche Tested



### APPLICATIONS

- Low-Side Switch in Synchronous Buck Converter

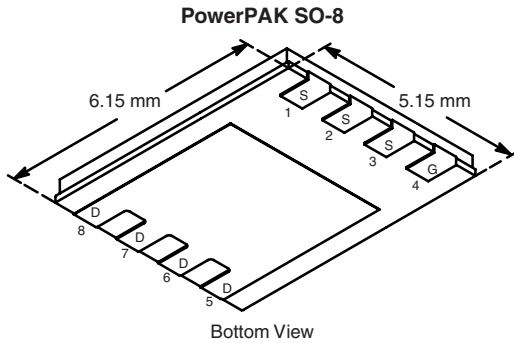

Bottom View

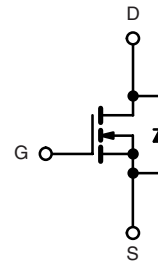

N-Channel MOSFET

Ordering Information: SIR888DP-T1-GE3 (Lead (Pb)-free and Halogen-free)

| ABSOLUTE MAXIMUM RATINGS T <sub>A</sub> = 25 °C, unless otherwise noted |                                   |                     |      |
|---|-----------------------------------|---------------------|------|
| Parameter   | Symbol                            | Limit               | Unit |
| Drain-Source Voltage  | V <sub>DS</sub>                   | 25                  | V    |
| Gate-Source Voltage   | V <sub>GS</sub>                   | ± 16                |      |
| Continuous Drain Current (T <sub>J</sub> = 150 °C)                      | T <sub>C</sub> = 25 °C            | 40 <sup>g</sup>     | A    |
|   | T <sub>C</sub> = 70 °C            | 40 <sup>g</sup>     |      |
|   | T <sub>A</sub> = 25 °C            | 29 <sup>b, c</sup>  |      |
|   | T <sub>A</sub> = 70 °C            | 23 <sup>b, c</sup>  |      |
| Pulsed Drain Current  | I <sub>DM</sub>                   | 70                  |      |
| Continuous Source-Drain Diode Current                                   | T <sub>C</sub> = 25 °C            | 40 <sup>g</sup>     |      |
|   | T <sub>A</sub> = 25 °C            | 4.5 <sup>b, c</sup> |      |
| Single Pulse Avalanche Current  | I <sub>AS</sub>                   | 40                  |      |
| Single Pulse Avalanche Energy   | E <sub>AS</sub>                   | 80                  | mJ   |
| Maximum Power Dissipation   | T <sub>C</sub> = 25 °C            | 48                  | W    |
|   | T <sub>C</sub> = 70 °C            | 31                  |      |
|   | T <sub>A</sub> = 25 °C            | 5.0 <sup>b, c</sup> |      |
|   | T <sub>A</sub> = 70 °C            | 3.2 <sup>b, c</sup> |      |
| Operating Junction and Storage Temperature Range                        | T <sub>J</sub> , T <sub>stg</sub> | - 55 to 150         | °C   |
| Soldering Recommendations (Peak Temperature) <sup>d, e</sup>            |                                   | 260                 |      |

| THERMAL RESISTANCE RATINGS                  |              |                   |         |         |      |
|---|--------------|-------------------|---------|---------|------|
| Parameter                                   |              | Symbol            | Typical | Maximum | Unit |
| Maximum Junction-to-Ambient <sup>b, f</sup> | t ≤ 10 s     | R <sub>thJA</sub> | 20      | 25      | °C/W |
| Maximum Junction-to-Case (Drain)            | Steady State | R <sub>thJC</sub> | 2.1     | 2.6     |      |

Notes:

- Based on T<sub>C</sub> = 25 °C.
- Surface Mounted on 1" x 1" FR4 board.
- t = 10 s.
- See Solder Profile (<http://www.vishay.com/ppg?73257>). The PowerPAK SO-8 is a leadless package. The end of the lead terminal is exposed copper (not plated) as a result of the singulation process in manufacturing. A solder fillet at the exposed copper tip cannot be guaranteed and is not required to ensure adequate bottom side solder interconnection.
- Rework Conditions: manual soldering with a soldering iron is not recommended for leadless components.
- Maximum under Steady State conditions is 70 °C/W.
- Package limited.

| SPECIFICATIONS $T_J = 25\text{ }^\circ\text{C}$ , unless otherwise noted |                         |   |      |        |           |                      |
|--|-------------------------|---|------|--------|-----------|----------------------|
| Parameter  | Symbol                  | Test Conditions   | Min. | Typ.   | Max.      | Unit                 |
| <b>Static</b>  |                         |   |      |        |           |                      |
| Drain-Source Breakdown Voltage   | $V_{DS}$                | $V_{GS} = 0\text{ V}, I_D = 250\text{ }\mu\text{A}$   | 25   |        |           | V                    |
| $V_{DS}$ Temperature Coefficient   | $\Delta V_{DS}/T_J$     | $I_D = 250\text{ }\mu\text{A}$  |      | 26     |           | mV/ $^\circ\text{C}$ |
| $V_{GS(th)}$ Temperature Coefficient                                     | $\Delta V_{GS(th)}/T_J$ |   |      | - 5.6  |           |                      |
| Gate-Source Threshold Voltage  | $V_{GS(th)}$            | $V_{DS} = V_{GS}, I_D = 250\text{ }\mu\text{A}$   | 0.8  |        | 2.2       | V                    |
| Gate-Source Leakage  | $I_{GSS}$               | $V_{DS} = 0\text{ V}, V_{GS} = \pm 16\text{ V}$   |      |        | $\pm 100$ | nA                   |
| Zero Gate Voltage Drain Current  | $I_{DSS}$               | $V_{DS} = 25\text{ V}, V_{GS} = 0\text{ V}$   |      |        | 1         | $\mu\text{A}$        |
|  |                         | $V_{DS} = 25\text{ V}, V_{GS} = 0\text{ V}, T_J = 55\text{ }^\circ\text{C}$   |      |        | 10        |                      |
| On-State Drain Current <sup>a</sup>                                      | $I_{D(on)}$             | $V_{DS} \geq 5\text{ V}, V_{GS} = 10\text{ V}$  | 30   |        |           | A                    |
| Drain-Source On-State Resistance <sup>a</sup>                            | $R_{DS(on)}$            | $V_{GS} = 10\text{ V}, I_D = 15\text{ A}$   |      | 0.0025 | 0.00325   | $\Omega$             |
|  |                         | $V_{GS} = 4.5\text{ V}, I_D = 10\text{ A}$  |      | 0.0031 | 0.004     |                      |
| Forward Transconductance <sup>a</sup>                                    | $g_{fs}$                | $V_{DS} = 15\text{ V}, I_D = 15\text{ A}$   |      | 97     |           | S                    |
| <b>Dynamic<sup>b</sup></b>   |                         |   |      |        |           |                      |
| Input Capacitance  | $C_{iss}$               | $V_{DS} = 15\text{ V}, V_{GS} = 0\text{ V}, f = 1\text{ MHz}$   |      | 5065   |           | pF                   |
| Output Capacitance   | $C_{oss}$               |   |      | 655    |           |                      |
| Reverse Transfer Capacitance   | $C_{rss}$               |   |      | 295    |           |                      |
| Total Gate Charge  | $Q_g$                   | $V_{DS} = 15\text{ V}, V_{GS} = 10\text{ V}, I_D = 20\text{ A}$   |      | 78     | 120       | nC                   |
|  |                         | $V_{DS} = 15\text{ V}, V_{GS} = 4.5\text{ V}, I_D = 20\text{ A}$  |      | 35.5   | 55        |                      |
| Gate-Source Charge   | $Q_{gs}$                |   |      | 12     |           |                      |
| Gate-Drain Charge  | $Q_{gd}$                |   |      | 8.1    |           |                      |
| Gate Resistance  | $R_g$                   | $f = 1\text{ MHz}$  | 0.2  | 0.55   | 1.1       | $\Omega$             |
| Turn-On Delay Time   | $t_{d(on)}$             | $V_{DD} = 15\text{ V}, R_L = 1.5\text{ }\Omega$<br>$I_D \cong 10\text{ A}, V_{GEN} = 4.5\text{ V}, R_g = 1\text{ }\Omega$ |      | 32     | 55        | ns                   |
| Rise Time  | $t_r$                   |   |      | 14     | 25        |                      |
| Turn-Off Delay Time  | $t_{d(off)}$            |   |      | 40     | 70        |                      |
| Fall Time  | $t_f$                   |   |      | 11     | 20        |                      |
| Turn-On Delay Time   | $t_{d(on)}$             | $V_{DD} = 15\text{ V}, R_L = 1.5\text{ }\Omega$<br>$I_D \cong 10\text{ A}, V_{GEN} = 10\text{ V}, R_g = 1\text{ }\Omega$  |      | 15     | 30        |                      |
| Rise Time  | $t_r$                   |   |      | 10     | 20        |                      |
| Turn-Off Delay Time  | $t_{d(off)}$            |   |      | 40     | 70        |                      |
| Fall Time  | $t_f$                   |   |      | 9      | 18        |                      |
| <b>Drain-Source Body Diode Characteristics</b>                           |                         |   |      |        |           |                      |
| Continuous Source-Drain Diode Current                                    | $I_S$                   | $T_C = 25\text{ }^\circ\text{C}$  |      |        | 40        | A                    |
| Pulse Diode Forward Current <sup>a</sup>                                 | $I_{SM}$                |   |      |        | 70        |                      |
| Body Diode Voltage   | $V_{SD}$                | $I_S = 2.7\text{ A}$  |      | 0.78   | 1.1       | V                    |
| Body Diode Reverse Recovery Time   | $t_{rr}$                | $I_F = 5\text{ A}, di/dt = 100\text{ A}/\mu\text{s}, T_J = 25\text{ }^\circ\text{C}$                                      |      | 36     | 65        | ns                   |
| Body Diode Reverse Recovery Charge                                       | $Q_{rr}$                |   |      | 36     | 60        | nC                   |
| Reverse Recovery Fall Time   | $t_a$                   |   |      | 19     |           | ns                   |
| Reverse Recovery Rise Time   | $t_b$                   |   |      | 17     |           |                      |

## Notes:

- a. Pulse test; pulse width  $\leq 300\text{ }\mu\text{s}$ , duty cycle  $\leq 2\%$ .  
b. Guaranteed by design, not subject to production testing.

Stresses beyond those listed under "Absolute Maximum Ratings" may cause permanent damage to the device. These are stress ratings only, and functional operation of the device at these or any other conditions beyond those indicated in the operational sections of the specifications is not implied. Exposure to absolute maximum rating conditions for extended periods may affect device reliability.



**TYPICAL CHARACTERISTICS** 25 °C, unless otherwise noted

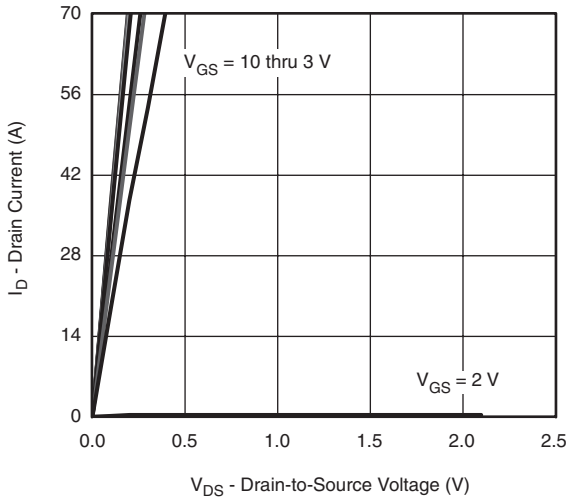

**Output Characteristics**

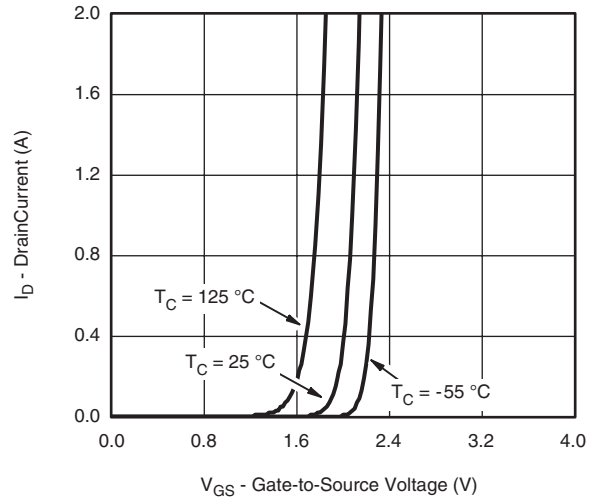

**Transfer Characteristics**

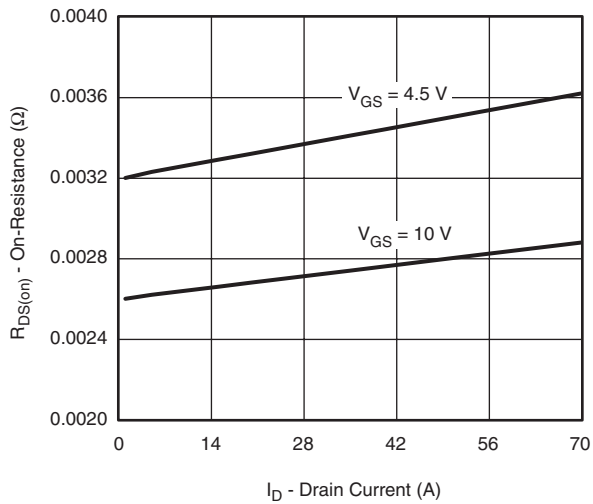

**On-Resistance vs. Drain Current and Gate Voltage**

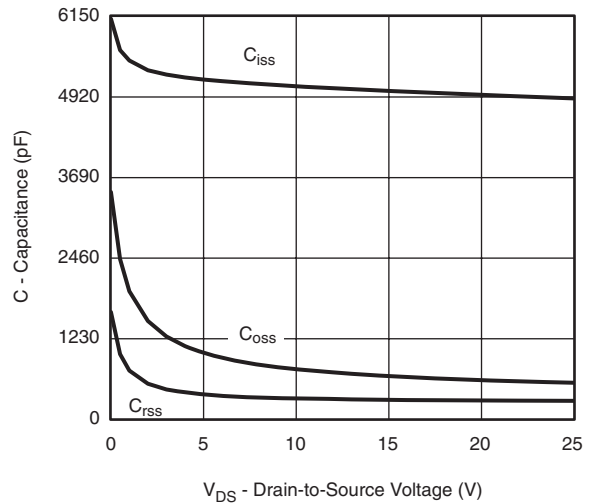

**Capacitance**

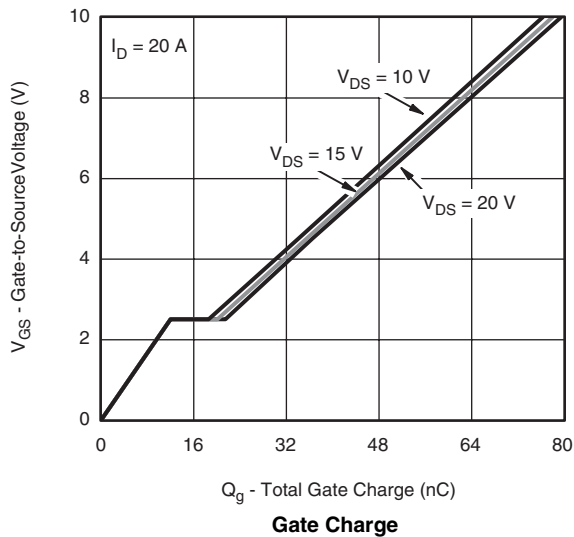

**Gate Charge**

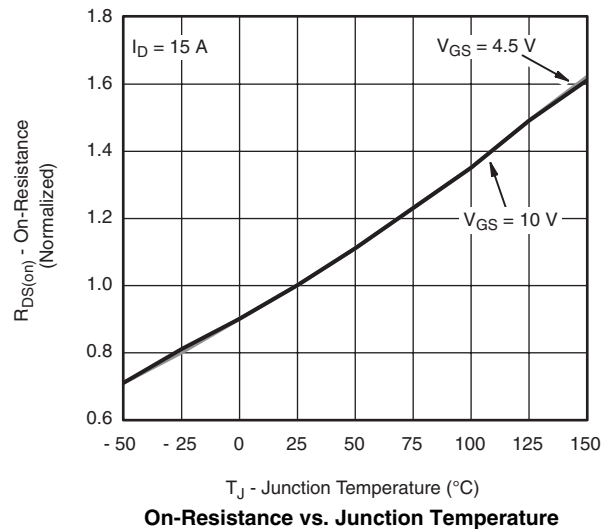

**On-Resistance vs. Junction Temperature**



**TYPICAL CHARACTERISTICS** 25 °C, unless otherwise noted

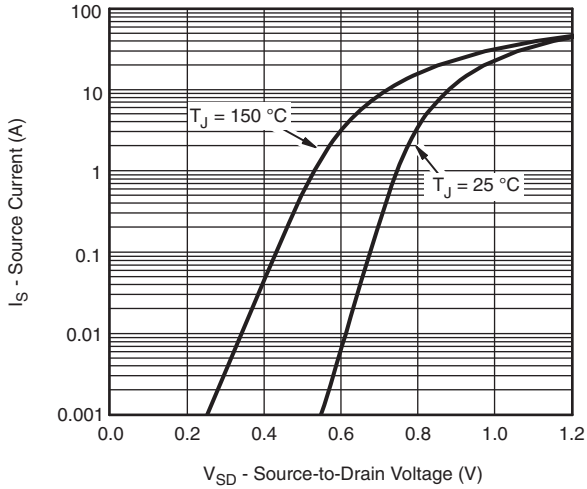

Source-Drain Diode Forward Voltage

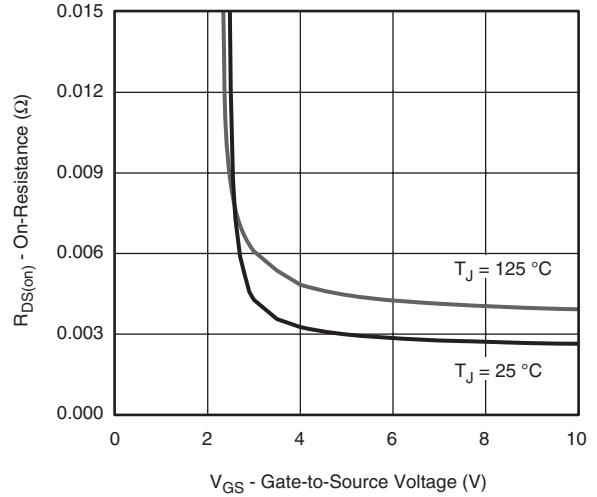

On-Resistance vs. Gate-to-Source Voltage

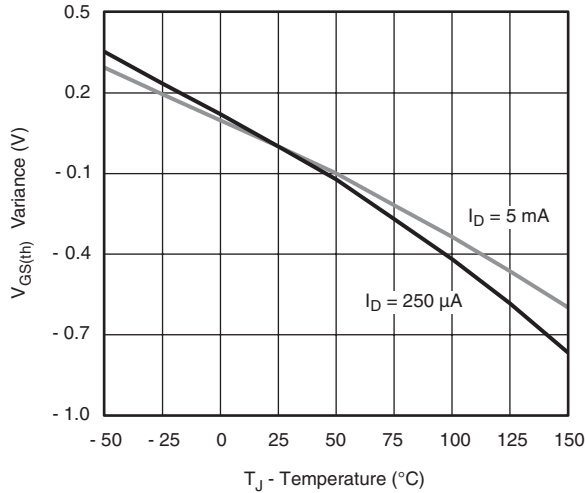

Threshold Voltage

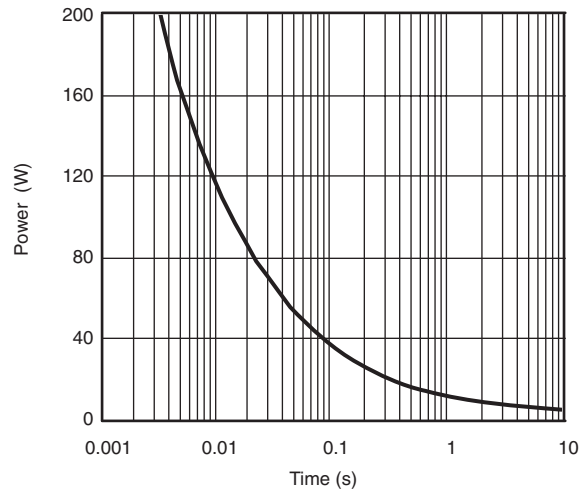

Single Pulse Power, Junction-to-Ambient

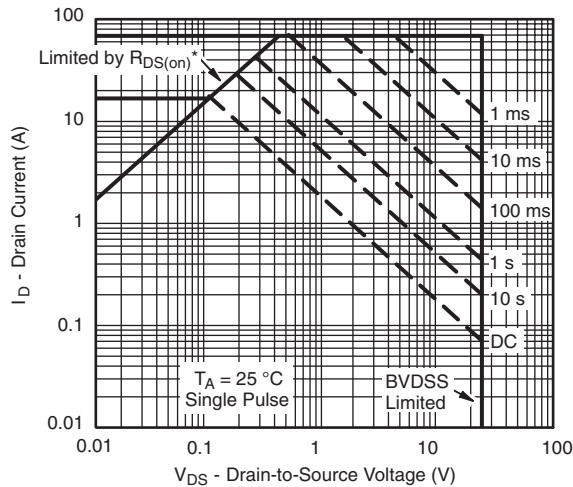

\*  $V_{GS} >$  minimum  $V_{GS}$  at which  $R_{DS(on)}$  is specified

Safe Operating Area, Junction-to-Ambient



**TYPICAL CHARACTERISTICS** 25 °C, unless otherwise noted

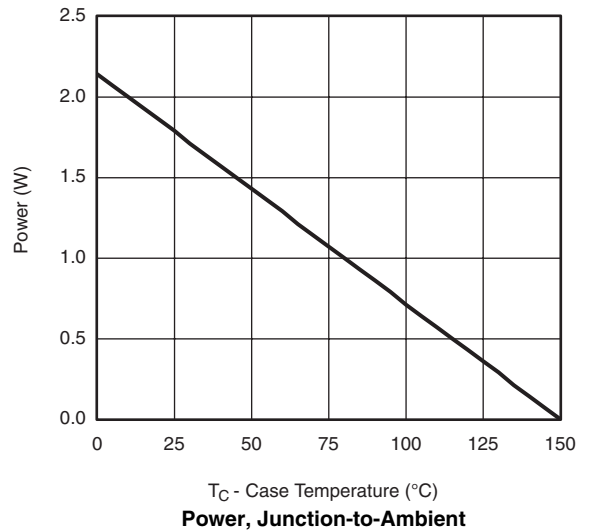
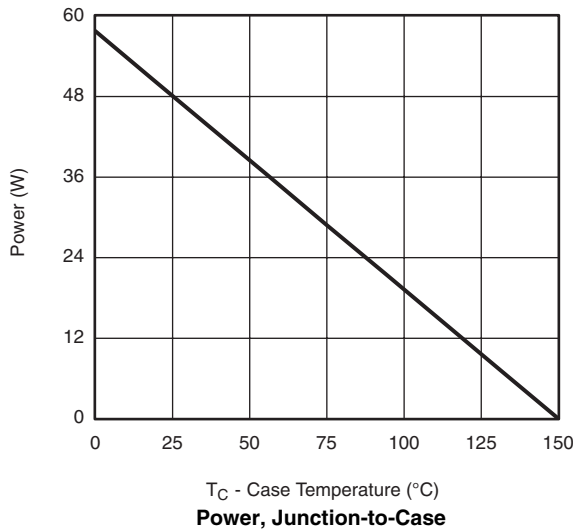
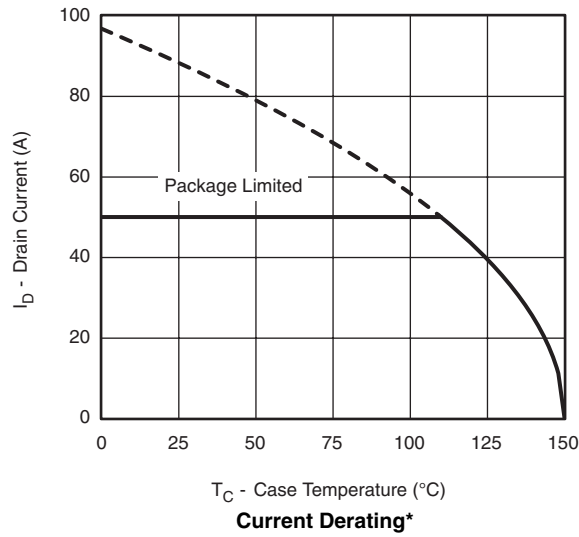

\* The power dissipation  $P_D$  is based on  $T_{J(max)} = 150$  °C, using junction-to-case thermal resistance, and is more useful in settling the upper dissipation limit for cases where additional heatsinking is used. It is used to determine the current rating, when this rating falls below the package limit.



**TYPICAL CHARACTERISTICS** 25 °C, unless otherwise noted

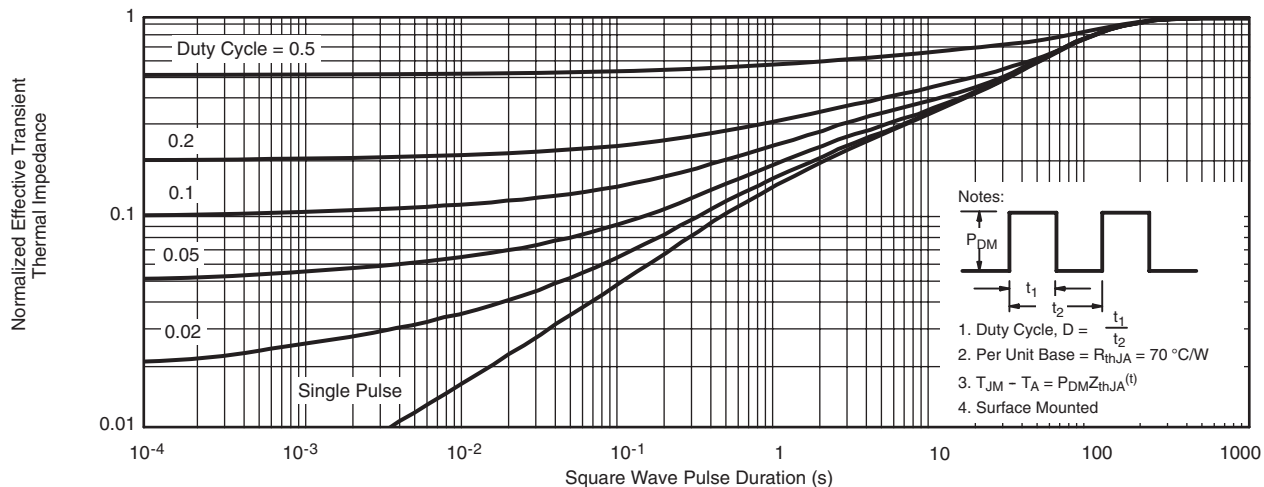

**Normalized Thermal Transient Impedance, Junction-to-Ambient**

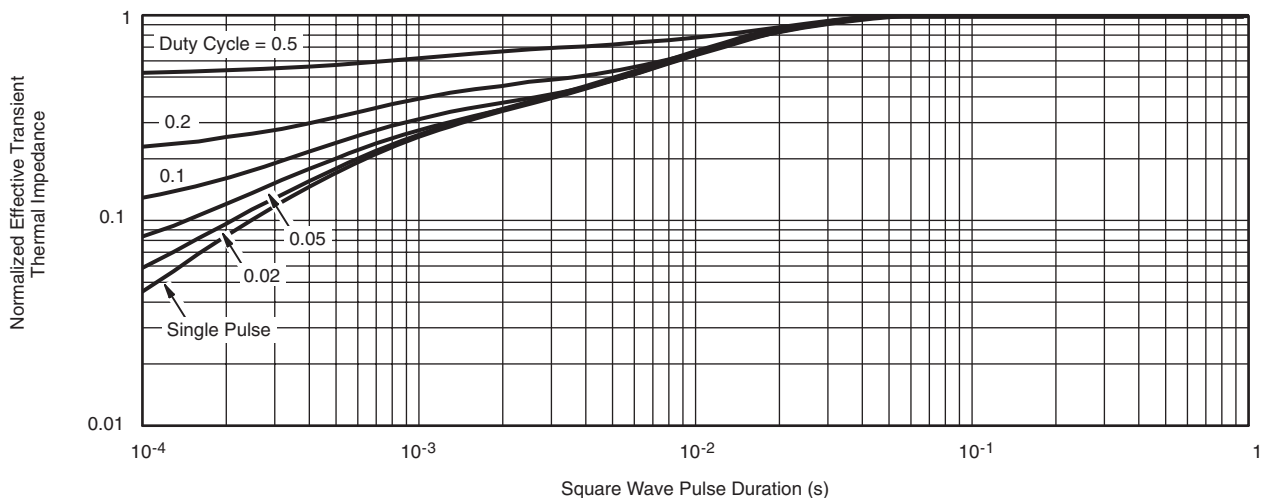

**Normalized Thermal Transient Impedance, Junction-to-Case**

Vishay Siliconix maintains worldwide manufacturing capability. Products may be manufactured at one of several qualified locations. Reliability data for Silicon Technology and Package Reliability represent a composite of all qualified locations. For related documents such as package/tape drawings, part marking, and reliability data, see <http://www.vishay.com/ppg?68627>.



## Notice

Specifications of the products displayed herein are subject to change without notice. Vishay Intertechnology, Inc., or anyone on its behalf, assumes no responsibility or liability for any errors or inaccuracies.

Information contained herein is intended to provide a product description only. No license, express or implied, by estoppel or otherwise, to any intellectual property rights is granted by this document. Except as provided in Vishay's terms and conditions of sale for such products, Vishay assumes no liability whatsoever, and disclaims any express or implied warranty, relating to sale and/or use of Vishay products including liability or warranties relating to fitness for a particular purpose, merchantability, or infringement of any patent, copyright, or other intellectual property right.

The products shown herein are not designed for use in medical, life-saving, or life-sustaining applications. Customers using or selling these products for use in such applications do so at their own risk and agree to fully indemnify Vishay for any damages resulting from such improper use or sale.