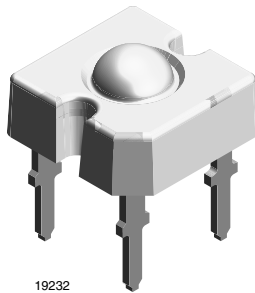

**TELUX™**

19232

**DESCRIPTION**

The TELUX™ series is a clear, non diffused LED for applications where supreme luminous flux is required. It is designed in an industry standard 7.62 mm square package utilizing highly developed (AS) AlInGaP technology.

The supreme heat dissipation of TELUX™ allows applications at high ambient temperatures.

All packing units are binned for luminous flux, forward voltage and color to achieve the most homogenous light appearance in application.

SAE and ECE color requirements for automobile application are available for color red.

ESD resistivity 2 kV (HBM) according to MIL STD 883D, method 3015.7.

**FEATURES**

- Utilizing one of the world's brightest (AS) AlInGaP technologies
- High luminous flux
- Supreme heat dissipation:  $R_{thJP}$  is 90 K/W
- High operating temperature:  
 $T_{amb} = -40\text{ °C to }+110\text{ °C}$
- Meets SAE and ECE color requirements for the automobile industry for color red
- Packed in tubes for automatic insertion
- Luminous flux, forward voltage and color categorized for each tube
- Small mechanical tolerances allow precise usage of external reflectors or lightguides
- Lead (Pb)-free component
- Component in accordance to RoHS 2002/95/EC and WEEE 2002/96/EC

**RoHS**  
COMPLIANT

**APPLICATIONS**

- Exterior lighting
- Dashboard illumination
- Tail-, stop- and turn signals of motor vehicles
- Replaces small incandescent lamps
- Traffic signals and signs

**PRODUCT GROUP AND PACKAGE DATA**

- Product group: LED
- Package: TELUX
- Product series: power
- Angle of half intensity:  $\pm 30^\circ$

**PARTS TABLE**

PART	COLOR, LUMINOUS INTENSITY	TECHNOLOGY
TLWR9600	Red, $\phi_V > 2500\text{ mlm}$	AlInGaP on GaAs



<b>ABSOLUTE MAXIMUM RATINGS<sup>1)</sup> TLWR9600</b>				
PARAMETER	TEST CONDITION	SYMBOL	VALUE	UNIT
Reverse voltage	$I_R = 100 \mu\text{A}$	$V_R$	10	V
DC Forward current	$T_{\text{amb}} \leq 85 \text{ }^\circ\text{C}$	$I_F$	70	mA
Surge forward current	$t_p \leq 10 \mu\text{s}$	$I_{\text{FSM}}$	0.1	A
Power dissipation	$T_{\text{amb}} \leq 85 \text{ }^\circ\text{C}$	$P_V$	187	mW
Junction temperature		$T_j$	125	$^\circ\text{C}$
Operating temperature range		$T_{\text{amb}}$	- 40 to + 110	$^\circ\text{C}$
Storage temperature range		$T_{\text{stg}}$	- 55 to + 110	$^\circ\text{C}$
Soldering temperature	$t \leq 5 \text{ s}$ , 1.5 mm from body preheat temperature 100 $^\circ\text{C}$ / 30 s	$T_{\text{sd}}$	260	$^\circ\text{C}$
Thermal resistance junction/ambient	with cathode heatsink of 70 mm <sup>2</sup>	$R_{\text{thJA}}$	200	K/W

Note:

<sup>1)</sup>  $T_{\text{amb}} = 25 \text{ }^\circ\text{C}$ , unless otherwise specified

<b>OPTICAL AND ELECTRICAL CHARACTERISTICS<sup>1)</sup> TLWR9600, RED</b>						
PARAMETER	TEST CONDITION	SYMBOL	MIN	TYP.	MAX	UNIT
Total flux	$I_F = 70 \text{ mA}$ , $R_{\text{thJA}} = 200 \text{ }^\circ\text{K/W}$	$\phi_V$	2500	3200		mlm
Luminous intensity/total flux	$I_F = 70 \text{ mA}$ , $R_{\text{thJA}} = 200 \text{ }^\circ\text{K/W}$	$I_V/\phi_V$		0.8		mcd/mlm
Dominant wavelength	$I_F = 70 \text{ mA}$ , $R_{\text{thJA}} = 200 \text{ }^\circ\text{K/W}$	$\lambda_d$	611	615	634	nm
Peak wavelength	$I_F = 70 \text{ mA}$ , $R_{\text{thJA}} = 200 \text{ }^\circ\text{K/W}$	$\lambda_p$		624		nm
Angle of half intensity	$I_F = 70 \text{ mA}$ , $R_{\text{thJA}} = 200 \text{ }^\circ\text{K/W}$	$\phi$		$\pm 30$		deg
Total included angle	90 % of total flux captured	$\phi_{0.9V}$		75		deg
Forward voltage	$I_F = 70 \text{ mA}$ , $R_{\text{thJA}} = 200 \text{ }^\circ\text{K/W}$	$V_F$	1.83	2.2	2.7	V
Reverse voltage	$I_R = 100 \mu\text{A}$	$V_R$	10	20		V
Temperature coefficient $\langle \lambda_d$	$I_F = 70 \text{ mA}$	$\text{TC}_{\lambda_d}$		17		nm/K
Temperature coefficient $V_F$	$I_F = 70 \text{ mA}$ , $T > - 25 \text{ }^\circ\text{C}$	$\text{TC}_{V_F}$		- 2.9		mV/K

Note:

<sup>1)</sup>  $T_{\text{amb}} = 25 \text{ }^\circ\text{C}$ , unless otherwise specified

**TYPICAL CHARACTERISTICS**

$T_{amb} = 25\text{ }^{\circ}\text{C}$ , unless otherwise specified

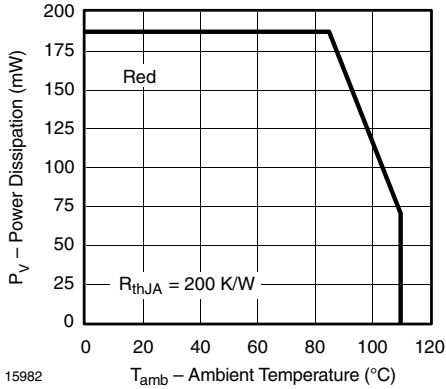

Figure 1. Power Dissipation vs. Ambient Temperature

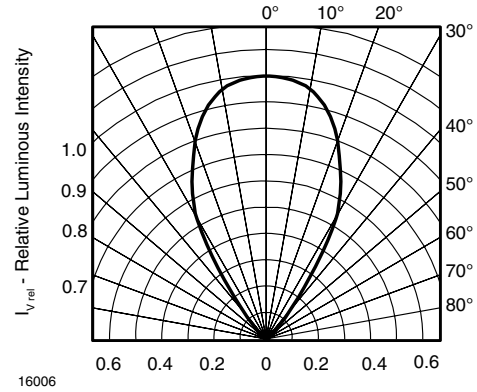

Figure 4. Rel. Luminous Intensity vs. Angular Displacement

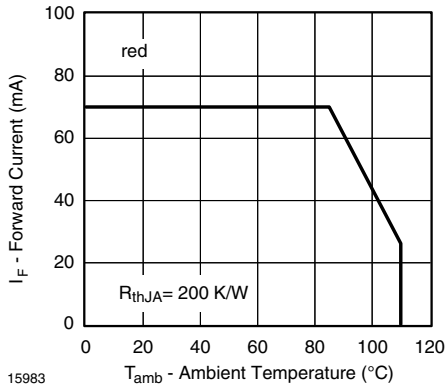

Figure 2. Forward Current vs. Ambient Temperature

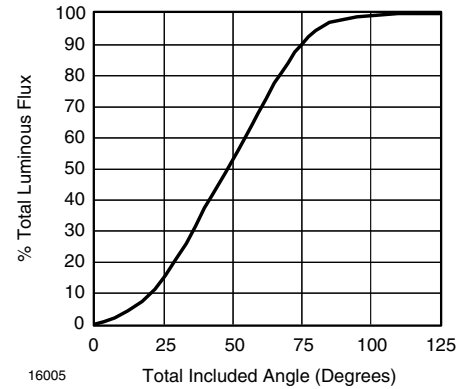

Figure 5. Percentage Total Luminous Flux vs. Total Included Angle for 60° emission angle

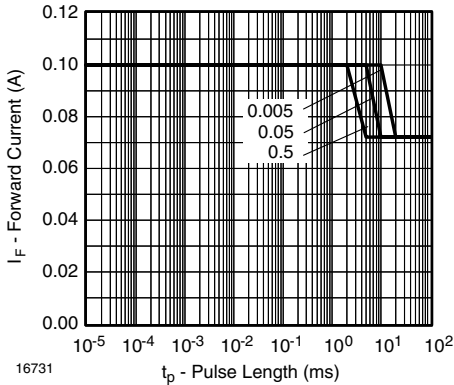

Figure 3. Forward Current vs. Pulse Length

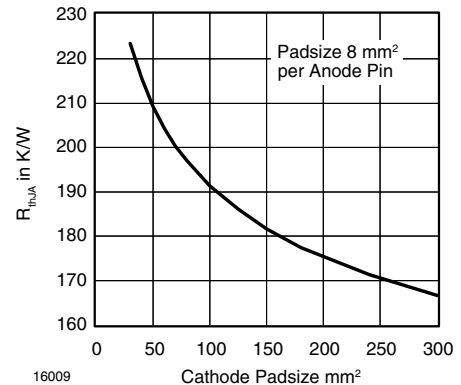
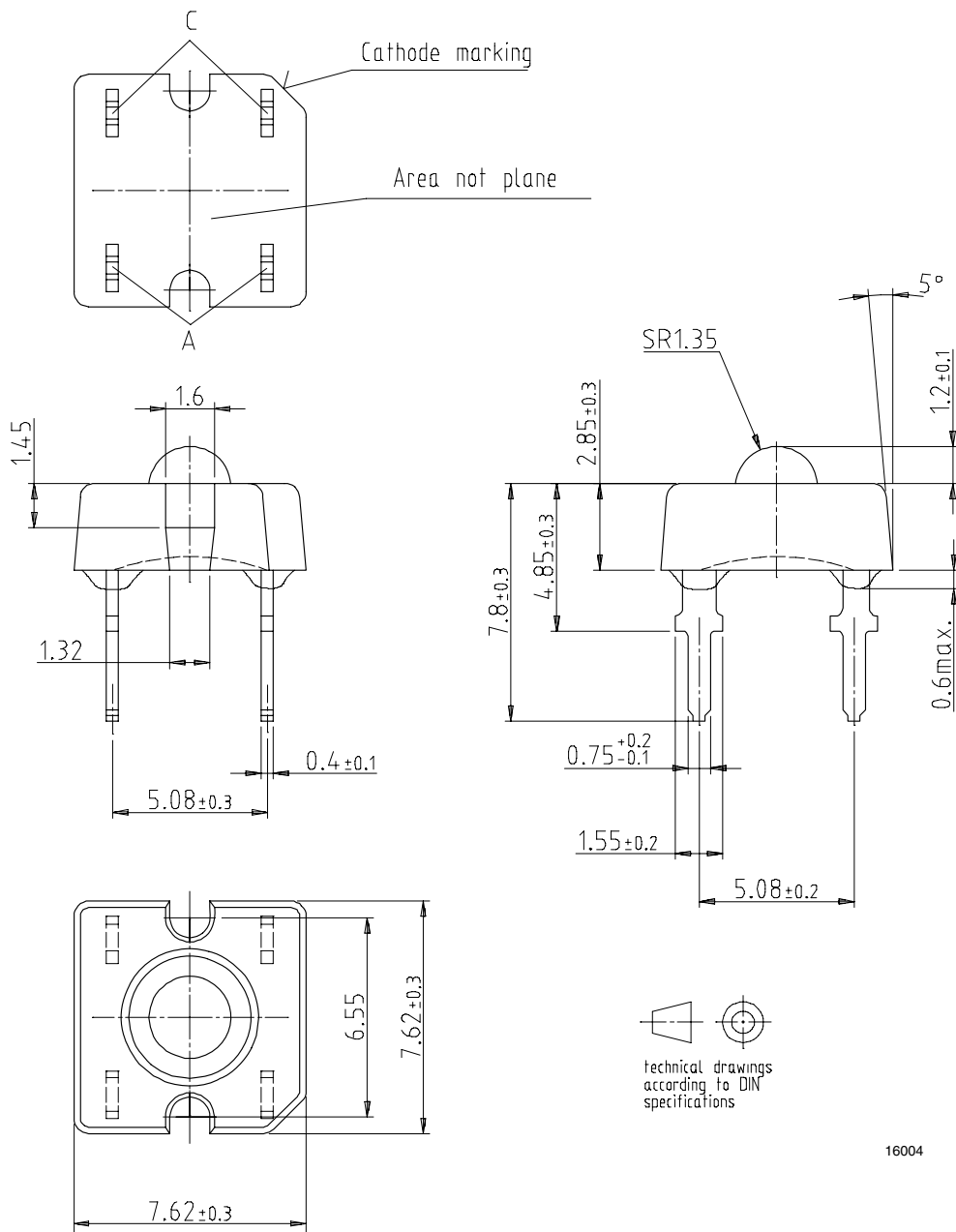

Figure 6. Thermal Resistance Junction Ambient vs. Cathode Padsize

### PACKAGE DIMENSIONS in millimeters



16004



## Ozone Depleting Substances Policy Statement

It is the policy of Vishay Semiconductor GmbH to

1. Meet all present and future national and international statutory requirements.
2. Regularly and continuously improve the performance of our products, processes, distribution and operating systems with respect to their impact on the health and safety of our employees and the public, as well as their impact on the environment.

It is particular concern to control or eliminate releases of those substances into the atmosphere which are known as ozone depleting substances (ODSs).

The Montreal Protocol (1987) and its London Amendments (1990) intend to severely restrict the use of ODSs and forbid their use within the next ten years. Various national and international initiatives are pressing for an earlier ban on these substances.

Vishay Semiconductor GmbH has been able to use its policy of continuous improvements to eliminate the use of ODSs listed in the following documents.

1. Annex A, B and list of transitional substances of the Montreal Protocol and the London Amendments respectively
2. Class I and II ozone depleting substances in the Clean Air Act Amendments of 1990 by the Environmental Protection Agency (EPA) in the USA
3. Council Decision 88/540/EEC and 91/690/EEC Annex A, B and C (transitional substances) respectively.

Vishay Semiconductor GmbH can certify that our semiconductors are not manufactured with ozone depleting substances and do not contain such substances.

We reserve the right to make changes to improve technical design  
and may do so without further notice.

Parameters can vary in different applications. All operating parameters must be validated for each customer application by the customer. Should the buyer use Vishay Semiconductors products for any unintended or unauthorized application, the buyer shall indemnify Vishay Semiconductors against all claims, costs, damages, and expenses, arising out of, directly or indirectly, any claim of personal damage, injury or death associated with such unintended or unauthorized use.

Vishay Semiconductor GmbH, P.O.B. 3535, D-74025 Heilbronn, Germany



## Disclaimer

All product specifications and data are subject to change without notice.

Vishay Intertechnology, Inc., its affiliates, agents, and employees, and all persons acting on its or their behalf (collectively, "Vishay"), disclaim any and all liability for any errors, inaccuracies or incompleteness contained herein or in any other disclosure relating to any product.

Vishay disclaims any and all liability arising out of the use or application of any product described herein or of any information provided herein to the maximum extent permitted by law. The product specifications do not expand or otherwise modify Vishay's terms and conditions of purchase, including but not limited to the warranty expressed therein, which apply to these products.

No license, express or implied, by estoppel or otherwise, to any intellectual property rights is granted by this document or by any conduct of Vishay.

The products shown herein are not designed for use in medical, life-saving, or life-sustaining applications unless otherwise expressly indicated. Customers using or selling Vishay products not expressly indicated for use in such applications do so entirely at their own risk and agree to fully indemnify Vishay for any damages arising or resulting from such use or sale. Please contact authorized Vishay personnel to obtain written terms and conditions regarding products designed for such applications.

Product names and markings noted herein may be trademarks of their respective owners.