

Power SMD LED PLCC-4

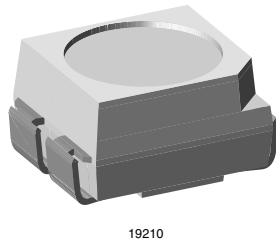

19210

DESCRIPTION

The VLMK/Y32.. is an advanced development in terms of heat dissipation.

The leadframe profile of this PLCC-4 SMD package is optimized to reduce the thermal resistance.

This allows higher drive current and doubles the light output compared to Vishay's high intensity SMD LED in PLCC-2 package.

PRODUCT GROUP AND PACKAGE DATA

- Product group: LED
- Package: SMD PLCC-4
- Product series: power
- Angle of half intensity: $\pm 60^\circ$

FEATURES

- Available in 8 mm tape
- High brightness SMD LED
- Luminous intensity and color categorized per packing unit
- Luminous intensity ratio per packing unit $I_{Vmax}/I_{Vmin} \leq 1.6$
- ESD-withstand voltage: up to 2 kV according to JESD22-A114-B
- Suitable for all soldering methods according to CECC 00802 and J-STD-020C
- Preconditioning: acc. to JEDEC level 2a
- Qualified according to JEDEC moisture sensitivity level 2a
- Automotive qualified: AEC-Q101
- Lead (Pb)-free device
- Component in accordance to RoHS 2002/95/EC and WEEE 2002/96/EC
- Compatible with IR reflow solder processes according to CECC 00802 and J-STD-020C



APPLICATIONS

- Interior and exterior lighting
- Indicator and backlighting purposes for audio, video, LCDs, switches, symbols, illuminated advertising etc.
- Illumination purpose, alternative to incandescent lamps
- General use

PARTS TABLE

PART	COLOR, LUMINOUS INTENSITY	TECHNOLOGY
VLMK32ABBB-GS08	Amber, $I_V = (1400 \text{ to } 2850) \text{ mcd}$	AllnGaP on Si
VLMY32ABBB-GS08	Yellow, $I_V = (1400 \text{ to } 2850) \text{ mcd}$	AllnGaP on Si

ABSOLUTE MAXIMUM RATINGS ¹⁾ VLMK/Y32..

PARAMETER	TEST CONDITION	SYMBOL	VALUE	UNIT
Reverse voltage ²⁾		V_R	5	V
Forward current		I_F	70	mA
Power dissipation		P_{tot}	200	mW
Junction temperature		T_j	125	$^\circ\text{C}$
Operating temperature range		T_{amb}	- 40 to + 100	$^\circ\text{C}$
Storage temperature range		T_{stg}	- 40 to + 100	$^\circ\text{C}$
Thermal resistance junction/ambient	mounted on PC board FR4	R_{thJA}	290	K/W

Note:

¹⁾ $T_{amb} = 25^\circ\text{C}$, unless otherwise specified

²⁾ Driving the LED in reverse direction is suitable for short term application



OPTICAL AND ELECTRICAL CHARACTERISTICS ¹⁾ VLMK32., AMBER								
PARAMETER	TEST CONDITION	PART	INCLUDED	SYMBOL	MIN.	TYP.	MAX.	UNIT
Luminous intensity ²⁾	$I_F = 50 \text{ mA}$	VLMK32ABBB	VLMK32AB	I_V	1400		1800	mcd
			VLMK32BA	I_V	1800		2240	mcd
			VLMK32BB	I_V	2240		2850	mcd
Dominant wavelength	$I_F = 50 \text{ mA}$			λ_d	610		621	nm
Spectral bandwidth at 50 % $I_{rel \text{ max}}$	$I_F = 50 \text{ mA}$			$\Delta\lambda$		18		nm
Angle of half intensity	$I_F = 50 \text{ mA}$			φ		± 60		deg
Forward voltage ³⁾	$I_F = 50 \text{ mA}$			V_F	1.85		3.03	V
Reverse current	$V_R = 5 \text{ V}$			I_R		0.01	10	μA

Note:

¹⁾ $T_{amb} = 25 \text{ }^\circ\text{C}$, unless otherwise specified

²⁾ In one packing unit $I_{Vmax}/I_{Vmin} \leq 1.6$

³⁾ Forward voltages are tested at a current pulse duration of 1 ms and a tolerance of $\pm 0.1 \text{ V}$

OPTICAL AND ELECTRICAL CHARACTERISTICS ¹⁾ VLMY32., YELLOW								
PARAMETER	TEST CONDITION	PART	INCLUDED	SYMBOL	MIN.	TYP.	MAX.	UNIT
Luminous intensity ²⁾	$I_F = 50 \text{ mA}$	VLMY32ABBB	VLMY32AB	I_V	1400		1800	mcd
			VLMY32BA	I_V	1800		2240	mcd
			VLMY32BB	I_V	2240		2850	mcd
Dominant wavelength	$I_F = 50 \text{ mA}$			λ_d	585	588	594	nm
Spectral bandwidth at 50 % $I_{rel \text{ max}}$	$I_F = 50 \text{ mA}$			$\Delta\lambda$		18		nm
Angle of half intensity	$I_F = 50 \text{ mA}$			φ		± 60		deg
Forward voltage ³⁾	$I_F = 50 \text{ mA}$			V_F	1.85		3.03	V
Reverse current	$V_R = 5 \text{ V}$			I_R		0.01	10	μA

Note:

¹⁾ $T_{amb} = 25 \text{ }^\circ\text{C}$, unless otherwise specified

²⁾ In one packing unit $I_{Vmax}/I_{Vmin} \leq 1.6$

³⁾ Forward voltages are tested at a current pulse duration of 1 ms and a tolerance of $\pm 0.1 \text{ V}$

LUMINOUS INTENSITY CLASSIFICATION			
GROUP	LIGHT INTENSITY (MCD)		
	STANDARD	MIN.	MAX.
AB	1400	1800	
BA	1800	2240	
BB	2240	2850	

Note:

Luminous intensity is tested at a current pulse duration of 25 ms and an accuracy of $\pm 11 \%$.

The above type numbers represent the order groups which include only a few brightness groups. Only one group will be shipped on each reel (there will be no mixing of two groups on each reel). In order to ensure availability, single brightness groups will not be orderable.

In a similar manner for colors where wavelength groups are measured and binned, single wavelength groups will be shipped on any one reel.

In order to ensure availability, single wavelength groups will not be orderable.

COLOR CLASSIFICATION				
GROUP	YELLOW		AMBER	
	DOM. WAVELENGTH (NM)			
	MIN.	MAX.	MIN.	MAX.
X	585	588		
Y	588	591		
Z	591	594		
W			610	615
X			615	621

Note:

Wavelengths are tested at a current pulse duration of 25 ms and an accuracy of $\pm 1 \text{ nm}$.

CROSSING TABLE	
VISHAY	OSRAM
VLMK32ABBB-GS08	LAE6SF-AABB
VLMY32ABBB-GS08	LYE6SF-AABB

TYPICAL CHARACTERISTICS

$T_{amb} = 25\text{ }^{\circ}\text{C}$, unless otherwise specified

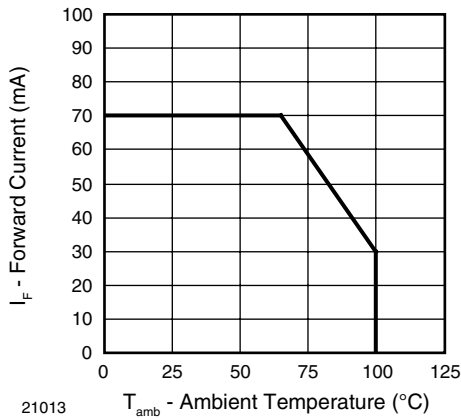

Figure 1. Forward Current vs. Ambient Temperature

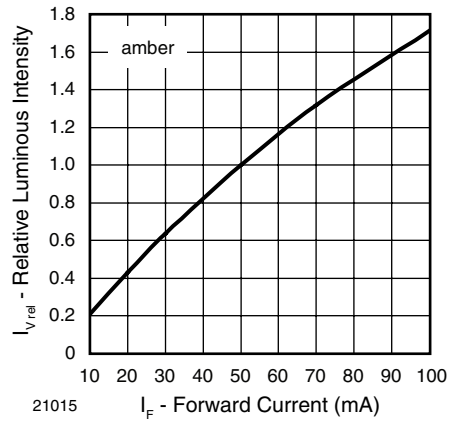

Figure 4. Relative Luminous Intensity vs. Forward Current

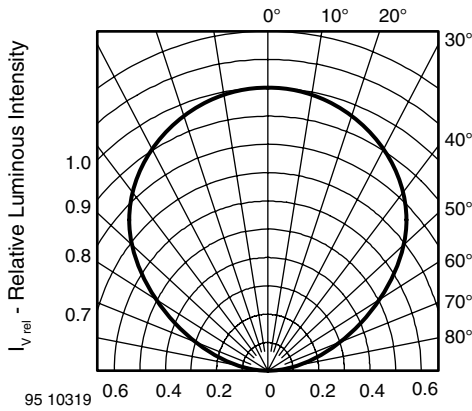

Figure 2. Rel. Luminous Intensity vs. Angular Displacement

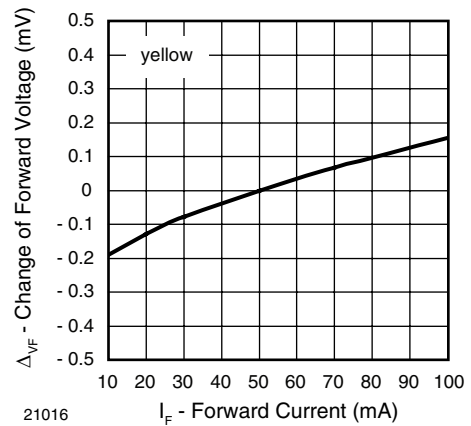

Figure 5. Change of Forward Voltage vs. Forward Current

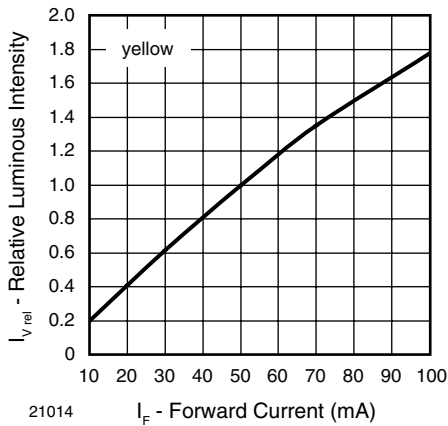

Figure 3. Relative Luminous Intensity vs. Forward Current

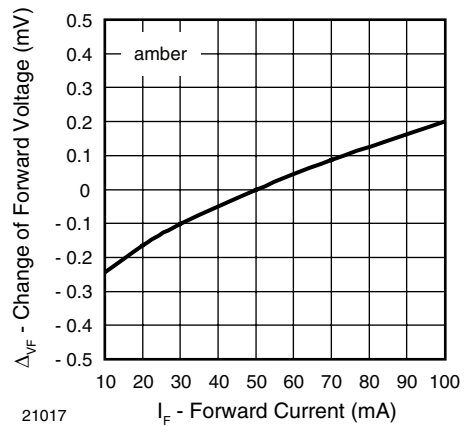

Figure 6. Change of Forward Voltage vs. Forward Current

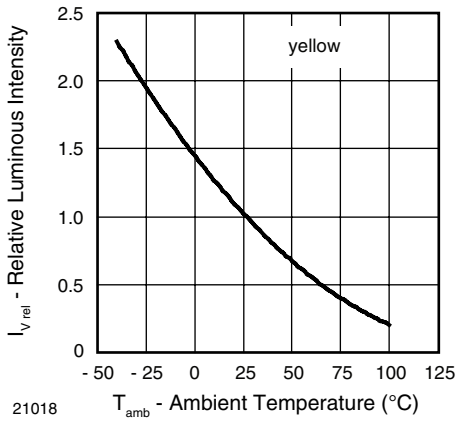

Figure 7. Relative Lum. Intensity vs. Ambient Temperature

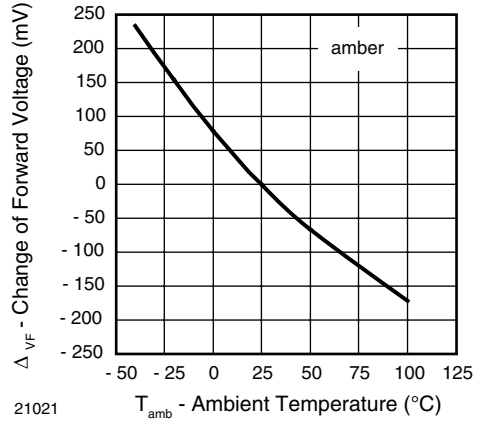

Figure 10. Change of Forward Voltage vs. Ambient Temperature

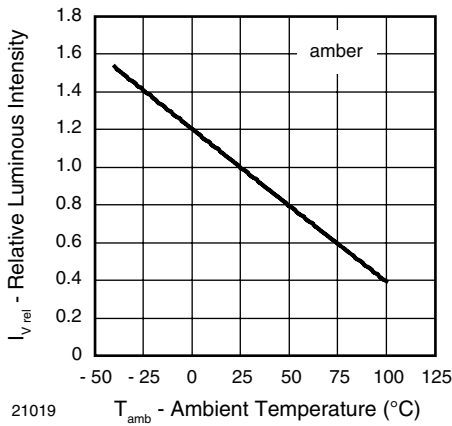

Figure 8. Relative Lum. Intensity vs. Ambient Temperature

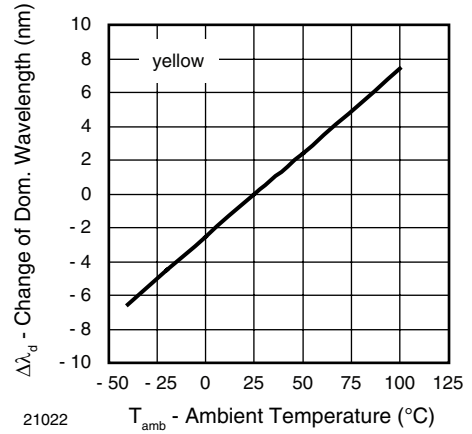

Figure 11. Change of Dominant Wavelength vs. Ambient Temperature

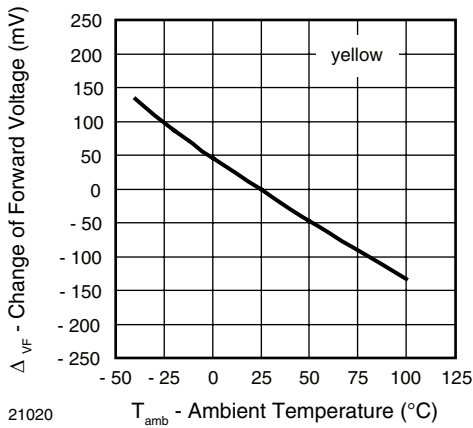

Figure 9. Change of Forward Voltage vs. Ambient Temperature

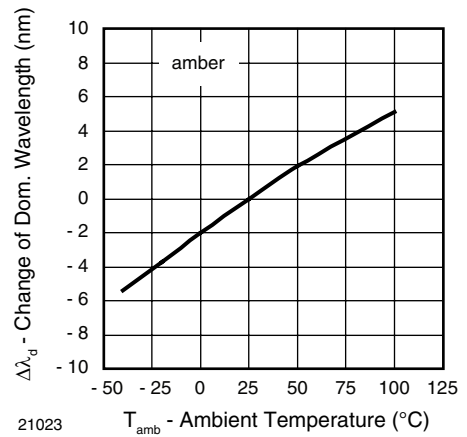

Figure 12. Change of Dominant Wavelength vs. Ambient Temperature

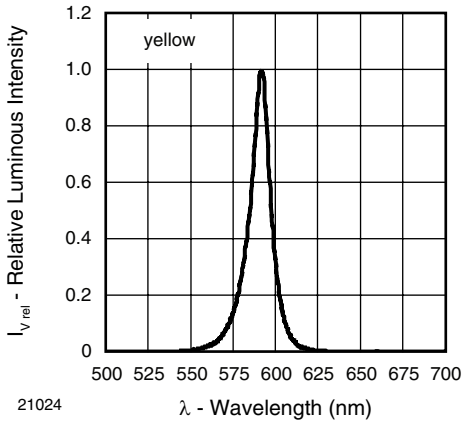

Figure 13. Relative Intensity vs. Wavelength

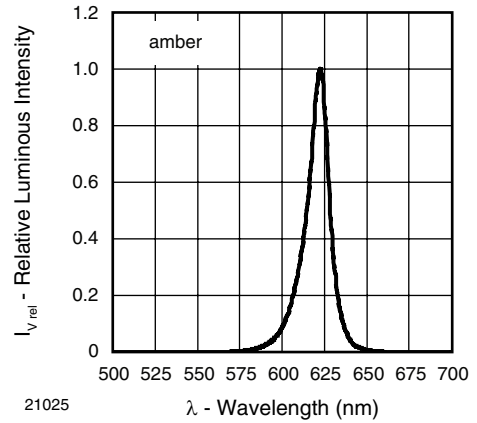
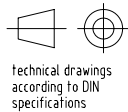
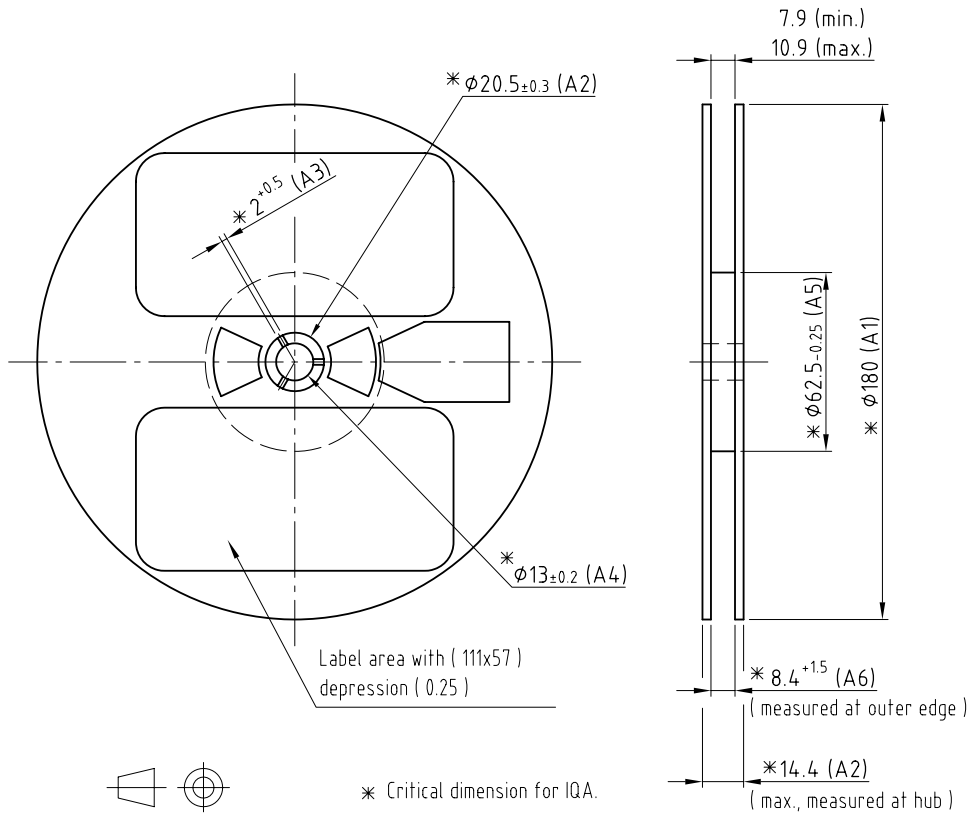

Figure 14. Relative Intensity vs. Wavelength

REEL DIMENSIONS in millimeters



* Critical dimension for IQA.

Not indicated tolerances ± 0.05
Material: black static dissipative

GS08 = 2000 pcs

Drawing refers to following types: $\phi 180$ mm Plastic reel
Drawing-No.: 9.800-5086.01-4
Issue: 1; 29.04.04
20983

TAPING DIMENSIONS in millimeters

Taping and orientation

Reels come in quantity of 2000 units.

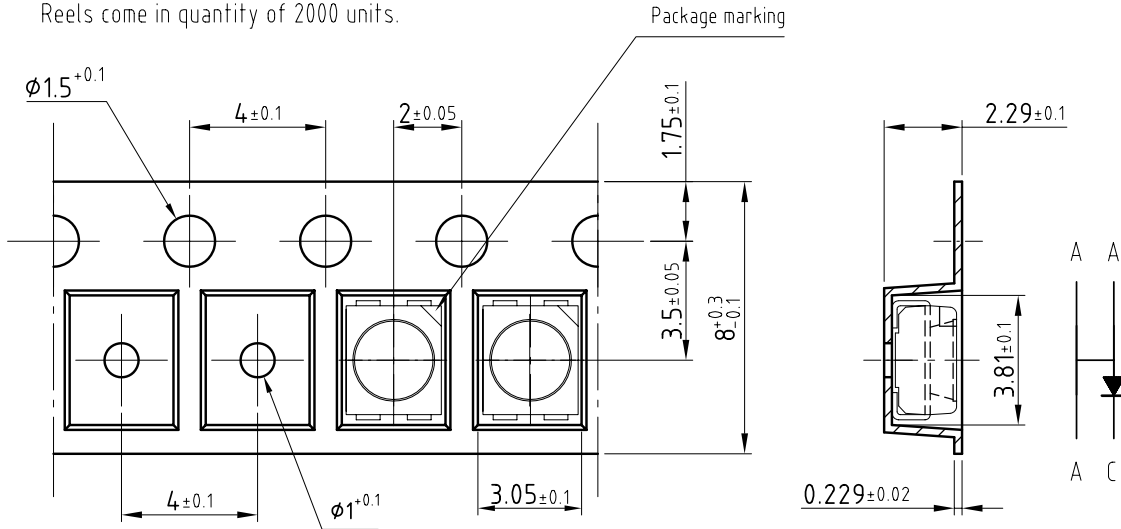

200mm min. for φ180 reel

480mm min. for φ180 reel

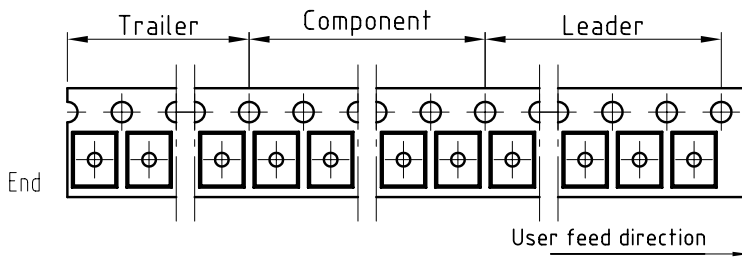

Drawing-No.: 9.700-5334.01-4

Issue: 2; 22.02.08

21066

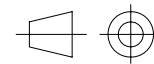

technical drawings
according to DIN
specifications

PACKAGE/SOLDERING PADS DIMENSIONS in millimeters

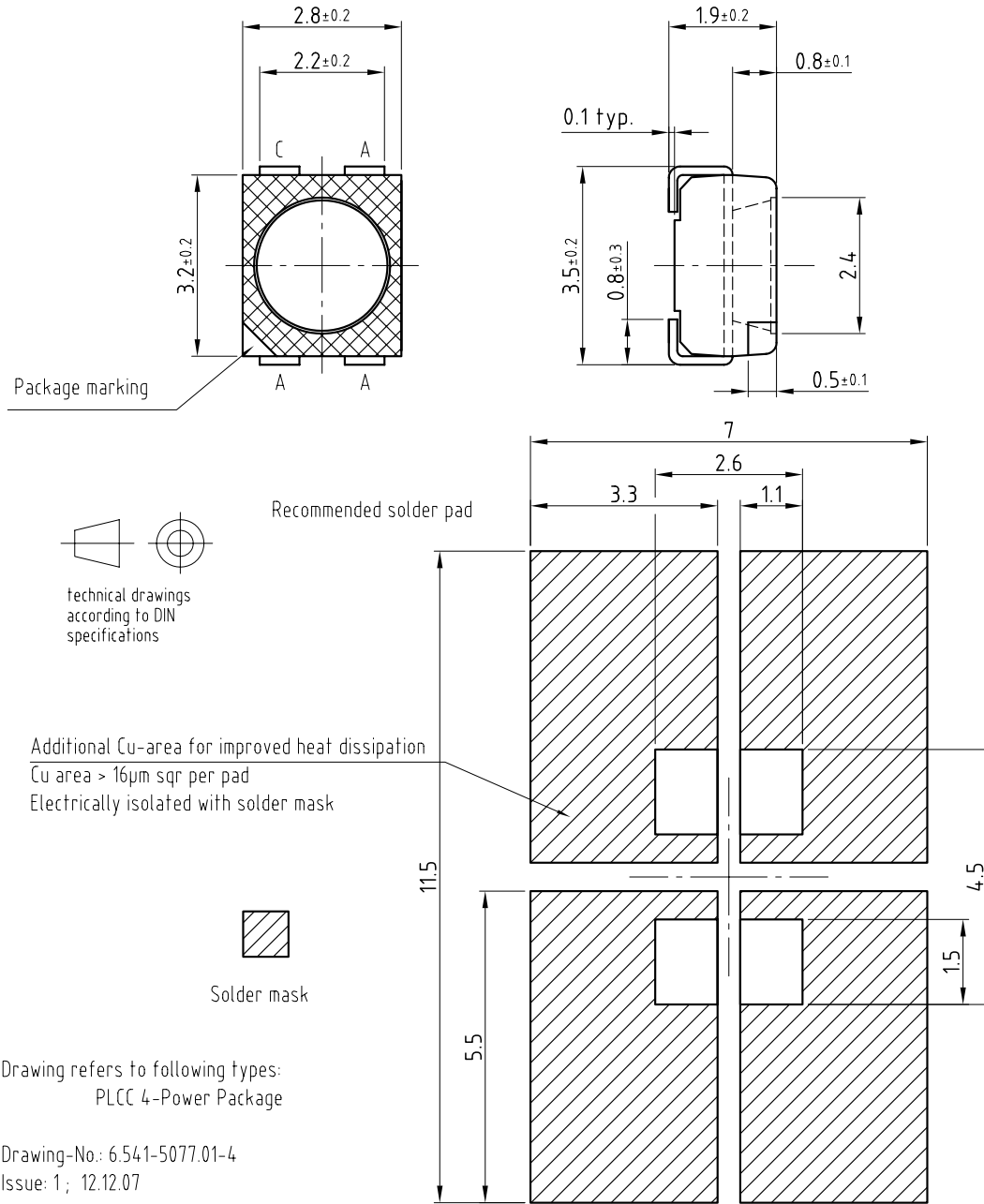

Drawing refers to following types:
PLCC 4-Power Package

Drawing-No.: 6.541-5077.01-4
Issue: 1; 12.12.07

20982

SOLDERING PROFILE

BAR CODE PRODUCT LABEL EXAMPLE:

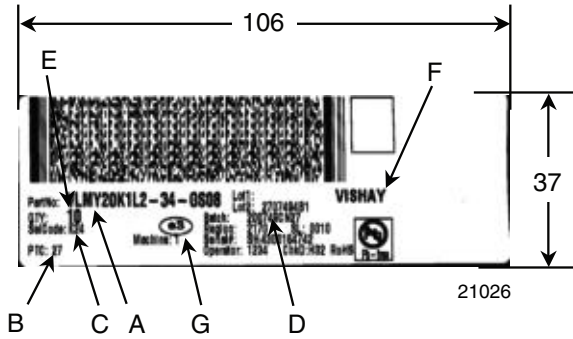
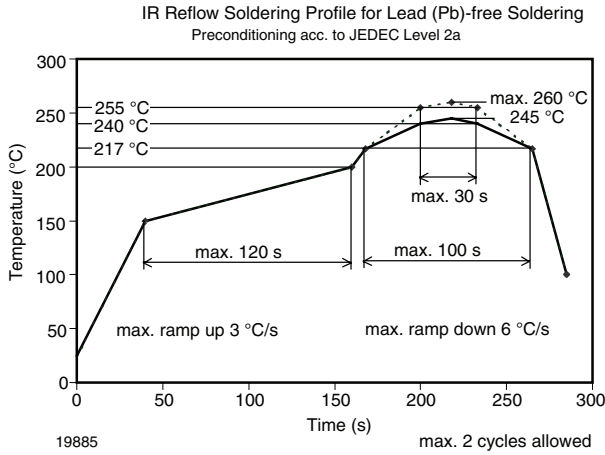

Figure 15. Vishay Lead (Pb)-free Reflow Soldering Profile (acc. to J-STD-020B)

- A) Type of component
- B) PTC = manufacturing plant
- C) SEL - selection code (bin):
e.g.: K2 = code for luminous intensity group
4 = code for color group
- D) Batch/date code
- E) Total quantity
- F) Company code
- G) Code for lead (Pb)-free classification (e3)

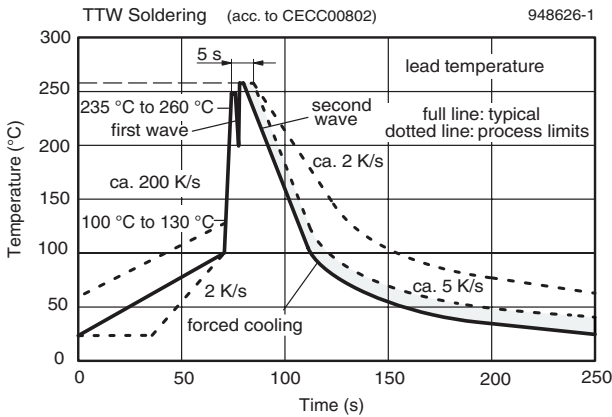
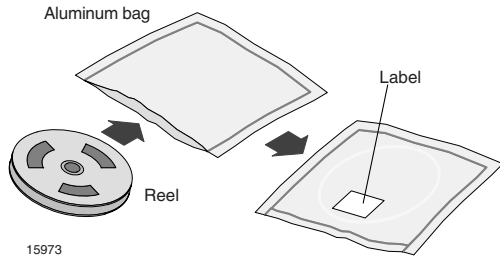

Figure 16. Double Wave Soldering of Opto Devices (all Packages)

DRY PACKING

The reel is packed in an anti-humidity bag to protect the devices from absorbing moisture during transportation and storage.



FINAL PACKING

The sealed reel is packed into a cardboard box. A secondary cardboard box is used for shipping purposes.

RECOMMENDED METHOD OF STORAGE

Dry box storage is recommended as soon as the aluminum bag has been opened to prevent moisture absorption. The following conditions should be observed, if dry boxes are not available:

- Storage temperature 10 °C to 30 °C
- Storage humidity ≤ 60 % RH max.

After more than 672 h under these conditions moisture content will be too high for reflow soldering.

In case of moisture absorption, the devices will recover to the former condition by drying under the following condition:

192 h at 40 °C + 5 °C/- 0 °C and < 5 % RH (dry air/nitrogen) or

96 h at 60 °C + 5 °C and < 5 % RH for all device containers or

24 h at 100 °C + 5 °C not suitable for reel or tubes.

An EIA JEDEC standard JESD22-A112 level 2a label is included on all dry bags.

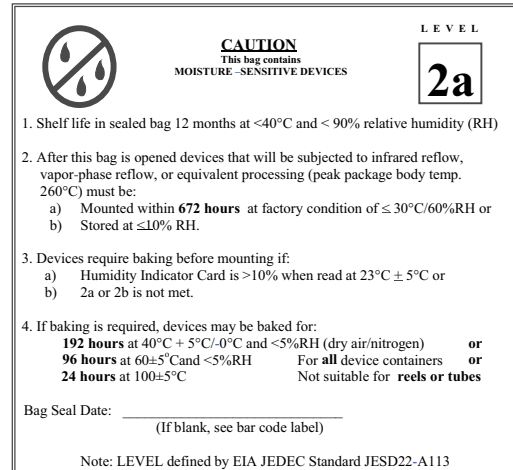

Example of JESD22-A112 level 2a label

ESD PRECAUTION

Proper storage and handling procedures should be followed to prevent ESD damage to the devices especially when they are removed from the antistatic shielding bag. Electro-static sensitive devices warning labels are on the packaging.

VISHAY SEMICONDUCTORS STANDARD BAR CODE LABELS

The Vishay Semiconductors standard bar code labels are printed at final packing areas. The labels are on each packing unit and contain Vishay Semiconductors specific data.

OZONE DEPLETING SUBSTANCES POLICY STATEMENT

It is the policy of Vishay Semiconductor GmbH to

1. Meet all present and future national and international statutory requirements.
2. Regularly and continuously improve the performance of our products, processes, distribution and operating systems with respect to their impact on the health and safety of our employees and the public, as well as their impact on the environment.

It is particular concern to control or eliminate releases of those substances into the atmosphere which are known as ozone depleting substances (ODSs).

The Montreal Protocol (1987) and its London Amendments (1990) intend to severely restrict the use of ODSs and forbid their use within the next ten years. Various national and international initiatives are pressing for an earlier ban on these substances.

Vishay Semiconductor GmbH has been able to use its policy of continuous improvements to eliminate the use of ODSs listed in the following documents.

1. Annex A, B and list of transitional substances of the Montreal Protocol and the London Amendments respectively.
2. Class I and II ozone depleting substances in the Clean Air Act Amendments of 1990 by the Environmental Protection Agency (EPA) in the USA.
3. Council Decision 88/540/EEC and 91/690/EEC Annex A, B and C (transitional substances) respectively.

Vishay Semiconductor GmbH can certify that our semiconductors are not manufactured with ozone depleting substances and do not contain such substances.

We reserve the right to make changes to improve technical design
and may do so without further notice.

Parameters can vary in different applications. All operating parameters must be validated for each customer application by the customer. Should the buyer use Vishay Semiconductors products for any unintended or unauthorized application, the buyer shall indemnify Vishay Semiconductors against all claims, costs, damages, and expenses, arising out of, directly or indirectly, any claim of personal damage, injury or death associated with such unintended or unauthorized use.

Vishay Semiconductor GmbH, P.O.B. 3535, D-74025 Heilbronn, Germany



Disclaimer

All product specifications and data are subject to change without notice.

Vishay Intertechnology, Inc., its affiliates, agents, and employees, and all persons acting on its or their behalf (collectively, "Vishay"), disclaim any and all liability for any errors, inaccuracies or incompleteness contained herein or in any other disclosure relating to any product.

Vishay disclaims any and all liability arising out of the use or application of any product described herein or of any information provided herein to the maximum extent permitted by law. The product specifications do not expand or otherwise modify Vishay's terms and conditions of purchase, including but not limited to the warranty expressed therein, which apply to these products.

No license, express or implied, by estoppel or otherwise, to any intellectual property rights is granted by this document or by any conduct of Vishay.

The products shown herein are not designed for use in medical, life-saving, or life-sustaining applications unless otherwise expressly indicated. Customers using or selling Vishay products not expressly indicated for use in such applications do so entirely at their own risk and agree to fully indemnify Vishay for any damages arising or resulting from such use or sale. Please contact authorized Vishay personnel to obtain written terms and conditions regarding products designed for such applications.

Product names and markings noted herein may be trademarks of their respective owners.