

# ZXMP4A16K

## 40V P-channel enhancement mode MOSFET

### Summary

$V_{(BR)DSS} = -40V$ ;  $R_{DS(ON)} = 0.060\Omega$   $I_D = -9.9A$

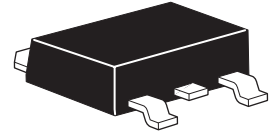

### Description

This new generation of trench MOSFETs from Zetex utilizes a unique structure that combines the benefits of low on-resistance with fast switching speed. This makes them ideal for high efficiency, low voltage, power management applications.

### Features

- Low on-resistance
- Fast switching speed
- Low threshold
- Low gate drive
- DPAK package

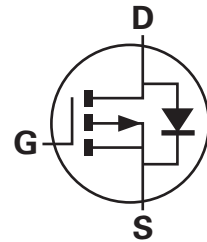

### Applications

- DC - DC converters
- Audio output stages
- Relay and solenoid driving
- Motor control

### Ordering information

Device	Reel size (inches)	Tape width	Quantity per reel
ZXMP4A16KTC	13	16mm	2500 units

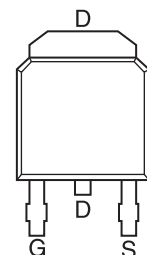

Pinout - Top view

### Device marking

ZXMP  
4A16

## Absolute maximum rating

Parameter	Symbol	Limit	Unit
Drain-source voltage	$V_{DSS}$	-40	V
Gate-source voltage	$V_{GS}$	$\pm 20$	V
Continuous drain current $V_{GS} = -10V; T_A = 25^\circ C$ <sup>(b)</sup> $V_{GS} = -10V; T_A = 70^\circ C$ <sup>(b)</sup> $V_{GS} = -10V; T_A = 25^\circ C$ <sup>(a)</sup>	$I_D$	-9.9 -8.0 -6.6	A A A
Pulsed drain current <sup>(c)</sup>	$I_{DM}$	-35	A
Continuous source current (body diode) <sup>(b)</sup>	$I_S$	-10.1	A
Pulsed source current (body diode) <sup>(c)</sup>	$I_{SM}$	-35	A
Power dissipation at $T_A = 25^\circ C$ <sup>(a)</sup> Linear derating factor	$P_D$	4.2 33.6	W mW/ $^\circ C$
Power dissipation at $T_A = 25^\circ C$ <sup>(b)</sup> Linear derating factor	$P_D$	9.5 76	W mW/ $^\circ C$
Power dissipation at $T_A = 25^\circ C$ <sup>(d)</sup> Linear derating factor	$P_D$	2.15 17.2	W mW/ $^\circ C$
Operating and storage temperature range	$T_j; T_{stg}$	-55 to +150	$^\circ C$
<b>Thermal resistance</b>			
Parameter	Symbol	Value	Unit
Junction to ambient <sup>(a)</sup>	$R_{\theta JA}$	30	$^\circ C/W$
Junction to ambient <sup>(b)</sup>	$R_{\theta JA}$	13.2	$^\circ C/W$
Junction to ambient <sup>(d)</sup>	$R_{\theta JA}$	58	$^\circ C/W$

### NOTES:

- (a) For a device surface mounted on 50mm x 50mm x 1.6mm FR4 PCB with high coverage of single sided 2oz copper, in still air conditions.
- (b) For a device surface mounted on FR4 PCB measured at  $t \leq 10$  sec.
- (c) Repetitive rating 50mm x 50mm x 1.6mm FR4 PCB,  $D=0.02$  pulse width=300 $\mu s$  - pulse width limited by maximum junction temperature.
- (d) For a device surface mounted on 25mm x 25mm x 1.6mm FR4 PCB with high coverage of single sided 1oz copper, in still air conditions.

## Characteristics

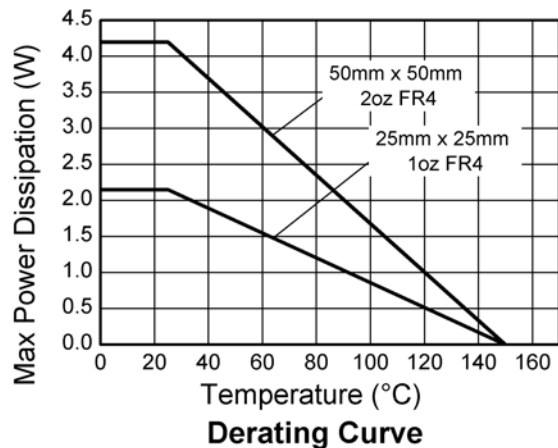
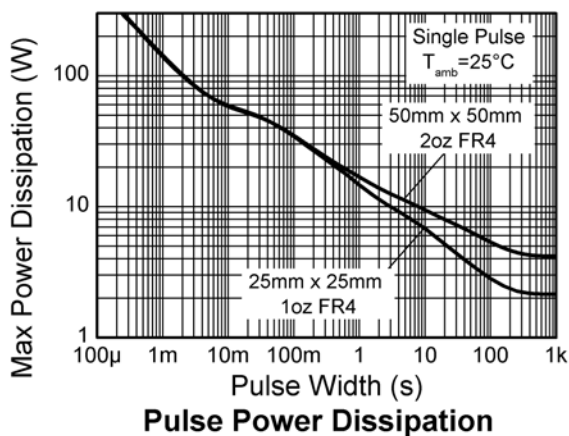
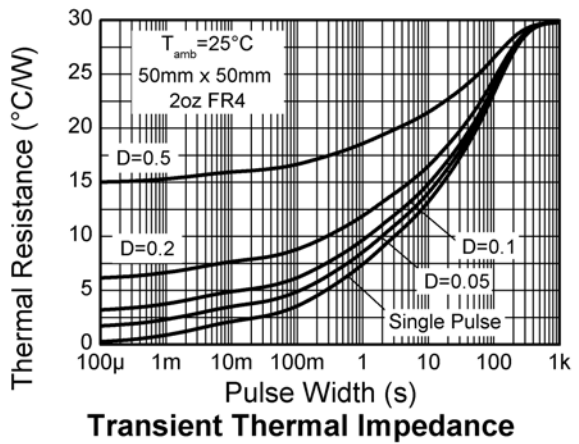
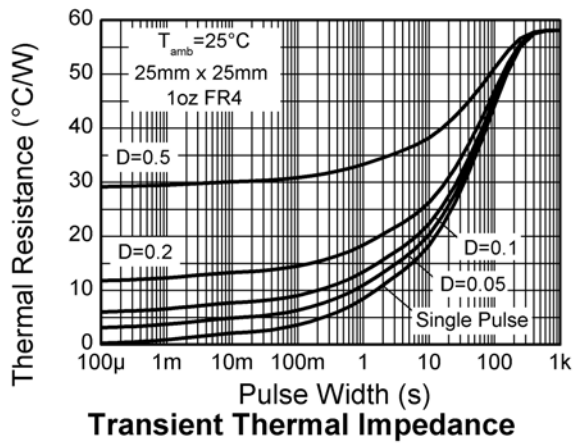
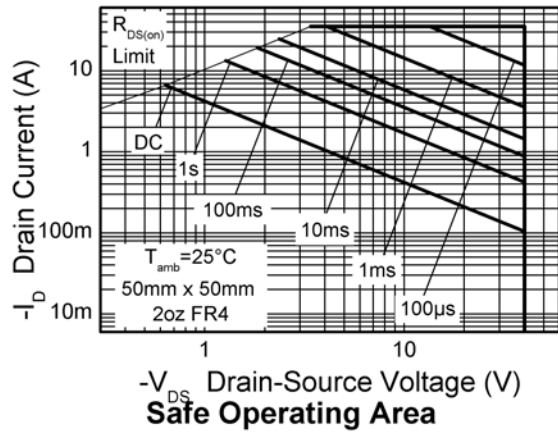
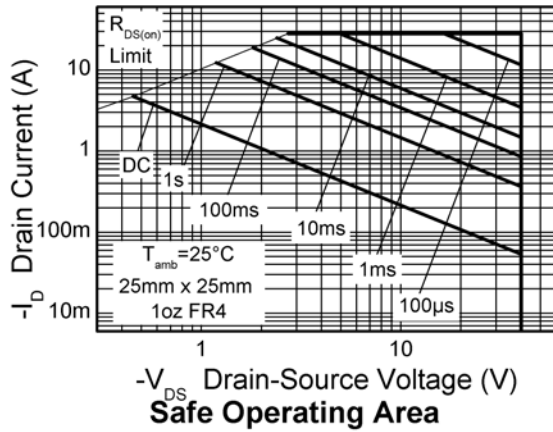

# ZXMP4A16K

## Electrical characteristics (at $T_A = 25^\circ\text{C}$ unless otherwise stated)

Parameter	Symbol	Min.	Typ.	Max.	Unit	Conditions
<b>Static</b>						
Drain-source breakdown voltage	$V_{(BR)DSS}$	-40			V	$I_D = -250\mu\text{A}$ , $V_{GS} = 0\text{V}$
Zero gate voltage drain current	$I_{DSS}$			-1	$\mu\text{A}$	$V_{DS} = -40\text{V}$ , $V_{GS} = 0\text{V}$
Gate-body leakage	$I_{GSS}$			100	nA	$V_{GS} = \pm 20\text{V}$ , $V_{DS} = 0\text{V}$
Gate-source threshold voltage	$V_{GS(th)}$	-1.0			V	$I_D = -250\mu\text{A}$ , $V_{DS} = V_{GS}$
Static drain-source on-state resistance (*)	$R_{DS(on)}$			0.060	$\Omega$	$V_{GS} = -10\text{V}$ , $I_D = -3.8\text{A}$
				0.100	$\Omega$	$V_{GS} = -4.5\text{V}$ , $I_D = -2.9\text{A}$
Forward transconductance (*)(‡)	$g_{fs}$		7.4		S	$V_{DS} = -15\text{V}$ , $I_D = -3.8\text{A}$
<b>Dynamic (‡)</b>						
Input capacitance	$C_{iss}$		965		pF	$V_{DS} = -20\text{V}$ , $V_{GS} = 0\text{V}$ , $f = 1\text{MHz}$
Output capacitance	$C_{oss}$		180		pF	
Reverse transfer capacitance	$C_{rss}$		158		pF	
<b>Switching (†)(‡)</b>						
Turn-on delay time	$t_{d(on)}$		4.0		ns	$V_{DD} = -20\text{V}$ , $I_D = -1\text{A}$ $R_G = 6.0\Omega$ , $V_{GS} = -10\text{V}$
Rise time	$t_r$		6.0		ns	
Turn-off delay time	$t_{d(off)}$		36.8		ns	
Fall time	$t_f$		17.1		ns	
Gate charge	$Q_g$		16.5		nC	$V_{DS} = -20\text{V}$ , $V_{GS} = -5\text{V}$ , $I_D = -3.8\text{A}$
Total gate charge	$Q_g$		29.6		nC	$V_{DS} = -20\text{V}$ , $V_{GS} = -10\text{V}$ , $I_D = -3.8\text{A}$
Gate-source charge	$Q_{gs}$		2.8		nC	
Gate-drain charge	$Q_{gd}$		8.1		nC	
<b>Source-drain diode</b>						
Diode forward voltage (*)	$V_{SD}$		-0.89	-1.2	V	$T_J = 25^\circ\text{C}$ , $I_S = -3.8\text{A}$ , $V_{GS} = 0\text{V}$
Reverse recovery time (‡)	$t_{rr}$		29.8		ns	$T_J = 25^\circ\text{C}$ , $I_F = -3.8\text{A}$ , $di/dt = 100\text{A}/\mu\text{s}$
Reverse recovery charge (‡)	$Q_{rr}$		37.2		nC	

### NOTES:

(\*) Measured under pulsed conditions. Width  $\leq 300\mu\text{s}$ . Duty cycle  $\leq 2\%$ .

(†) Switching characteristics are independent of operating junction temperature.

(‡) For design aid only, not subject to production testing.

## Typical characteristics

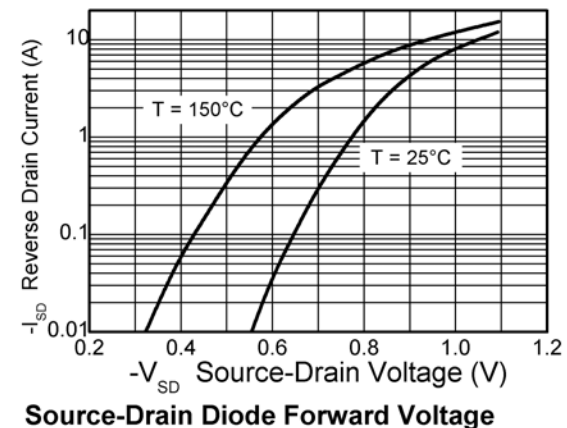
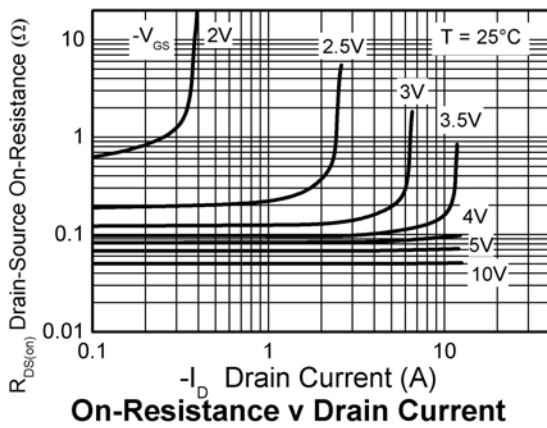
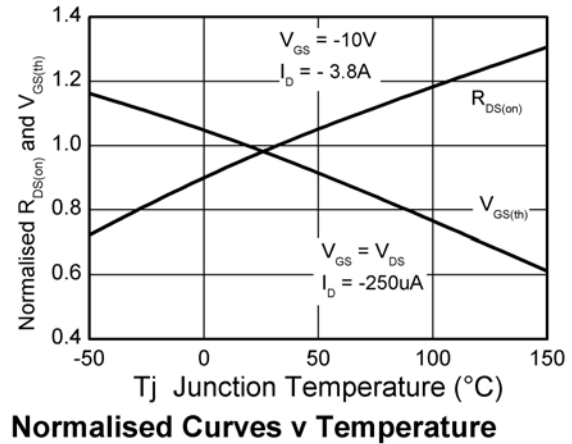
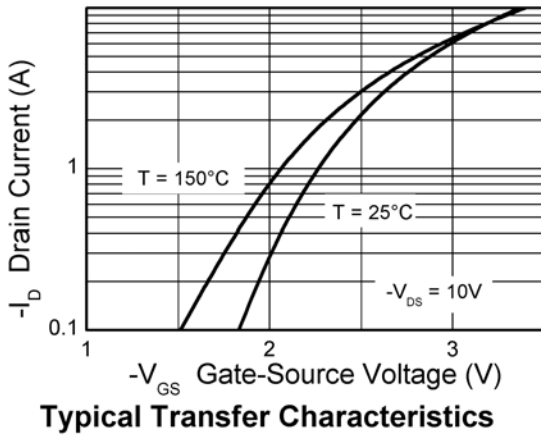
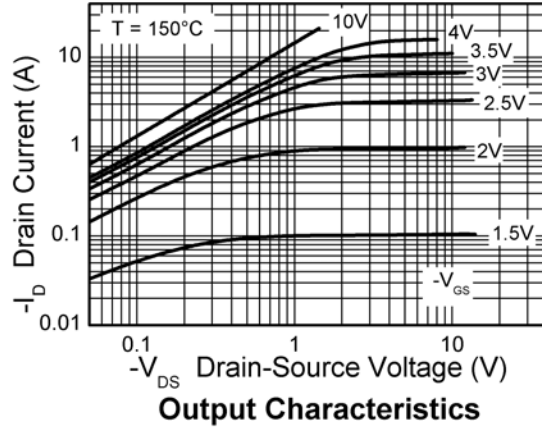
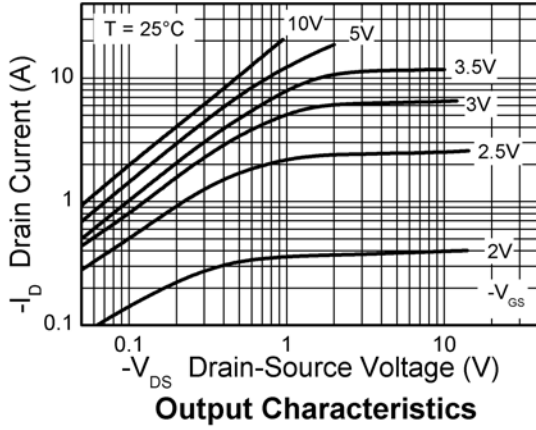

## Typical characteristics

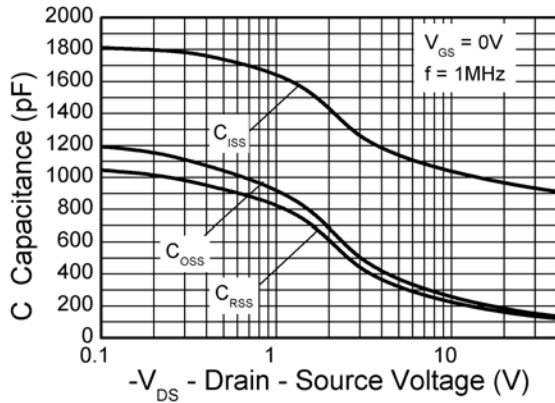

**Capacitance v Drain-Source Voltage**

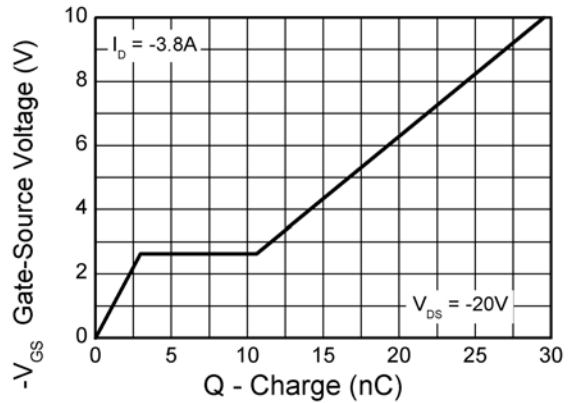

**Gate-Source Voltage v Gate Charge**

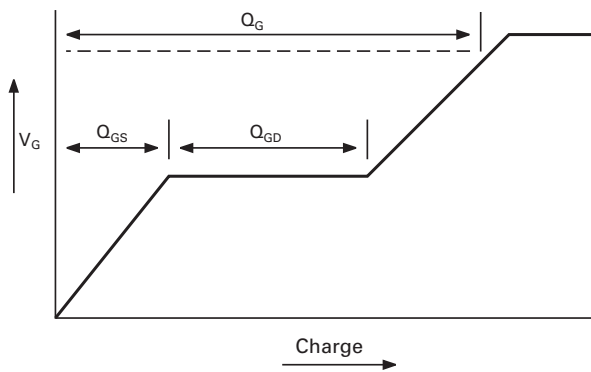

**Basic gate charge waveform**

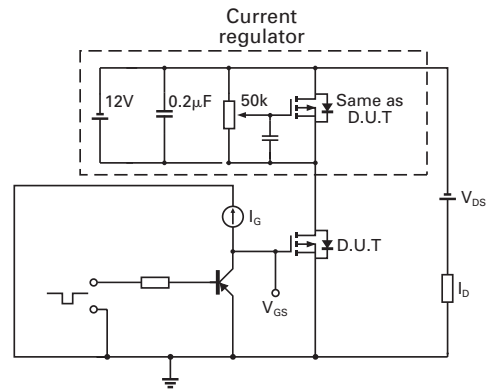

**Gate charge test circuit**

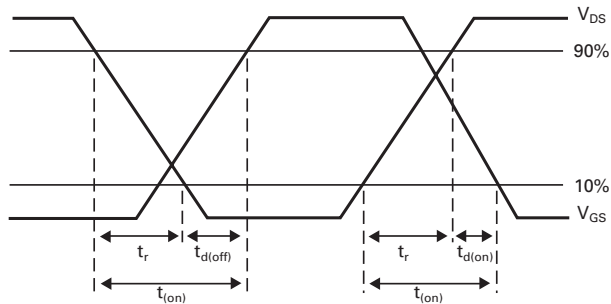

**Switching time waveforms**

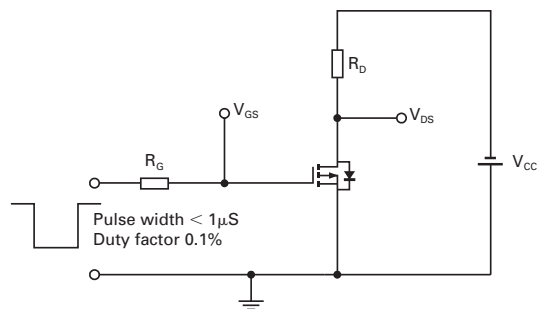

**Switching time test circuit**

# ZXMP4A16K

Intentionally left blank

# ZXMP4A16K

## Package details - DPAK

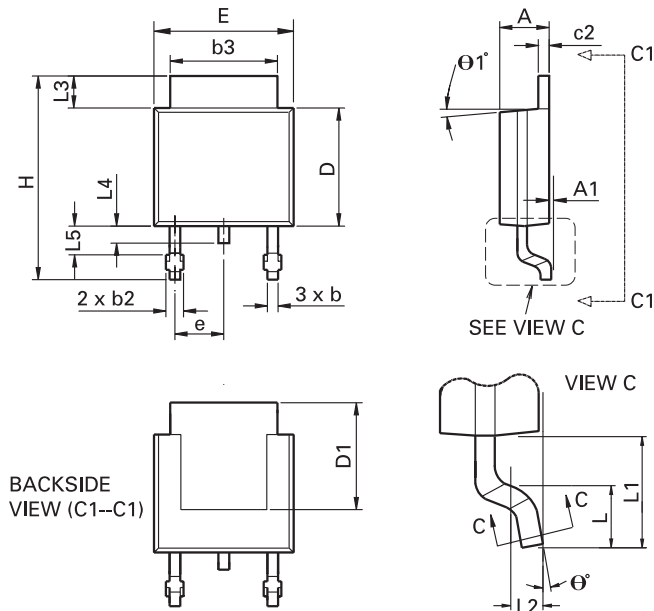

## Package dimensions

Dim.	Inches		Millimeters		Dim.	Inches		Millimeters	
	Min.	Max.	Min.	Max.		Min.	Max.	Min.	Max.
A	0.086	0.094	2.18	2.39	e	0.090 BSC		2.29 BSC	
A1	-	0.005	-	0.127	H	0.370	0.410	9.40	10.41
b	0.020	0.035	0.508	0.89	L	0.055	0.070	1.40	1.78
b2	0.030	0.045	0.762	1.14	L1	0.108 REF		2.74 REF	
b3	0.205	0.215	5.21	5.46	L2	0.020 BSC		0.508 BSC	
c	0.018	0.024	0.457	0.61	L3	0.035	0.065	0.89	1.65
c2	0.018	0.023	0.457	0.584	L4	0.025	0.040	0.635	1.016
D	0.213	0.245	5.41	6.22	L5	0.045	0.060	1.14	1.52
D1	0.205	-	5.21	-	theta 1°	0°	10°	0°	10°
E	0.250	0.265	6.35	6.73	theta 0°	0°	15°	0°	15°
E1	0.170	-	4.32	-	-	-	-	-	-

**Note:** Controlling dimensions are in inches. Approximate dimensions are provided in millimeters

### Europe

Zetex GmbH  
Streitfeldstraße 19  
D-81673 München  
Germany

Telefon: (49) 89 45 49 49 0  
Fax: (49) 89 45 49 49 49  
europe.sales@zetex.com

### Americas

Zetex Inc  
700 Veterans Memorial Highway  
Hauppauge, NY 11788  
USA

Telephone: (1) 631 360 2222  
Fax: (1) 631 360 8222  
usa.sales@zetex.com

### Asia Pacific

Zetex (Asia Ltd)  
3701-04 Metroplaza Tower 1  
Hing Fong Road, Kwai Fong  
Hong Kong

Telephone: (852) 26100 611  
Fax: (852) 24250 494  
asia.sales@zetex.com

### Corporate Headquarters

Zetex Semiconductors plc  
Zetex Technology Park, Chadderton  
Oldham, OL9 9LL  
United Kingdom

Telephone: (44) 161 622 4444  
Fax: (44) 161 622 4446  
hq@zetex.com

For international sales offices visit [www.zetex.com/offices](http://www.zetex.com/offices)

Zetex products are distributed worldwide. For details, see [www.zetex.com/salesnetwork](http://www.zetex.com/salesnetwork)

This publication is issued to provide outline information only which (unless agreed by the company in writing) may not be used, applied or reproduced for any purpose or form part of any order or contact or be regarded as a representation relating to the products or services concerned. The company reserves the right to alter without notice the specification, design, price or conditions of supply of any product or service.