

Silicon Bipolar RFIC Amplifiers

Technical Data

Features

MSA-3111

- Surface Mount SOT-143 Package
- 3 dB Bandwidth: DC to 0.5 GHz
- 18.4 dB Gain at 1 GHz
- 3.5 dB NF at 1 GHz

MSA-3135

- Hermetic Ceramic Package
- 3 dB Bandwidth: DC to 0.6 GHz
- 19.6 dB Gain at 1 GHz
- 3.2 dB NF at 1 GHz

MSA-3185

- Plastic Microstrip Package
- 3 dB Bandwidth: DC to 0.5 GHz
- 18.7 dB Gain at 1 GHz
- 3.5 dB NF at 1 GHz

MSA-3186

- Surface Mount Plastic Microstrip Package
- 3 dB Bandwidth: DC to 0.5 GHz
- 18.7 dB Gain at 1 GHz
- 3.5 dB NF at 1 GHz

MSA-3111

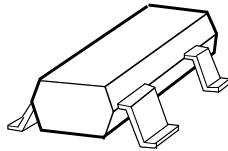

MSA-3135

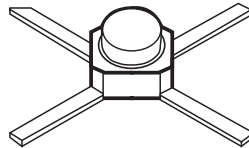

MSA-3185

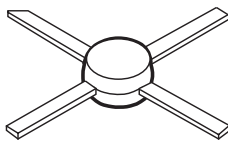

MSA-3186

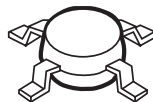

MSA-31XX Series

Description

The MSA-31XX series are high performance silicon bipolar RFIC amplifiers designed to be cascaded in 50Ω systems. The stability factor of $K > 1$ contributes to easy cascading in numerous narrow and broadband IF and RF commercial and industrial applications.

The MODAMP MSA series is fabricated using a 10 GHz f_T , 25 GHz F_{MAX} , silicon bipolar RFIC process which utilizes nitride self-alignment, ion implantation, and gold metallization to achieve excellent uniformity, performance, and reliability. The use of an external bias resistor for temperature and current stability also allows bias flexibility.

Package options include, the industry standard plastic surface mount SOT-143 package, the 100 mil surface mountable hermetic ceramic package, the 85 mil plastic microstripline package, and the 85 mil surface mountable plastic microstripline package.

Absolute Maximum Ratings^[1]

Parameter	MSA-3111	MSA-3135	MSA-3185, -3186
Device Current	50 mA	60 mA	60 mA
Power Dissipation ^[2,3]	250 mW ^[3a]	325 mW ^[3b]	325 mW ^[3c]
RF Input Power	+13 dBm	+13 dBm	+13 dBm
Junction Temperature	150°C	200°C	150°C
Storage Temperature	-65 to 150°C	-65 to 200°C	-65 to 150°C

Thermal Resistance: θ_{jc}	500°C/W	155°C/W	115°C/W
-----------------------------------	---------	---------	---------

Notes:

- Permanent damage may occur if any of these limits are exceeded.
- $T_{CASE} = 25^\circ\text{C}$.
- Derate at 2.0 mW/°C for $T_C > 25^\circ\text{C}$.
 - Derate at 6.5 mW/°C for $T_C > 149^\circ\text{C}$.
 - Derate at 8.7 mW/°C for $T_C > 112^\circ\text{C}$.

Typical Biasing Configuration

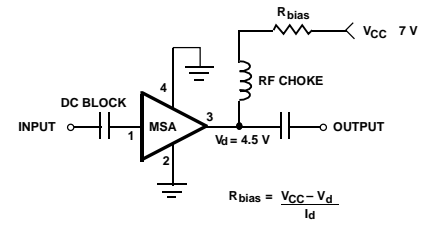

Electrical Specifications, $T_A = 25^\circ\text{C}$

$I_D = 29\text{ mA}$, $Z_0 = 50\ \Omega$

Symbol	Parameters and Test Conditions	Units	MSA-3111			MSA-3135			MSA-3185, -3186					
			Min.	Typ.	Max.	Min.	Typ.	Max.	Min.	Typ.	Max.			
G_p	Power Gain ($S_{21}P$)	dB	23.5	24.4		23.5	24.5	26.5	23.5	24.6				
	$f = 0.1\text{ GHz}$											22.4	22.8	22.3
	$f = 1.0\text{ GHz}$											18.4	19.6	18.7
ΔG_p	Gain Flatness $f = 0.1\text{ to }0.3\text{ GHz}$	dB		± 0.5		± 0.4	± 1.0		± 0.5					
f_{3dB}	3 dB Bandwidth	GHz		0.5		0.6			0.5					
VSWR	Input VSWR $f = 0.1\text{ to }3.0\text{ GHz}$			1.2:1		1.2:1			1.2:1					
	Output VSWR $f = 0.1\text{ to }3.0\text{ GHz}$			1.2:1		1.2:1			1.4:1					
P_{1dB}	Power Output @ 1 dB Gain Compression: $f = 1.0\text{ GHz}$	dBm		9.0		9.3			9.0					
NF	50 Ω Noise Figure $f = 1.0\text{ GHz}$	dB		3.5		3.2			3.5					
IP_3	Third Order Intercept Point $f = 1.0\text{ GHz}$	dBm		23		22			21					
t_d	Group Delay $f = 1.0\text{ GHz}$	psec		130		130			130					
V_D	Device Voltage $T_C = 25^\circ\text{C}$	V	4.0	4.5	6.0	4.5	4.7	5.5	4.0	4.7	6.0			
dV/dT	Device Voltage Temperature Coefficient	mV/°C		-9.6			-9.6			-9.6				

Note: 1. Refer to “Tape and Reel Packaging for Surface Mount Devices.”

Typical Performance for MSA-3111

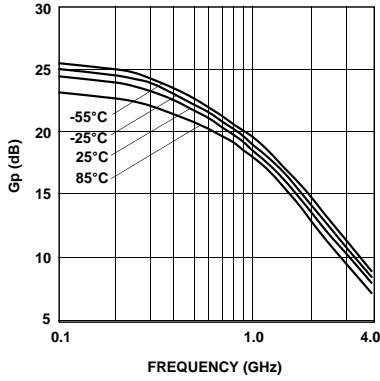

Figure 1. Power Gain vs. Frequency at Four Temperatures, $I_D = 29$ mA.

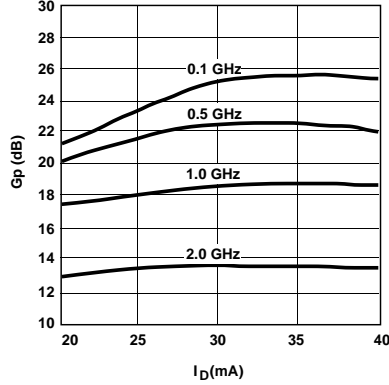

Figure 2. Power Gain vs. Current at 25°C.

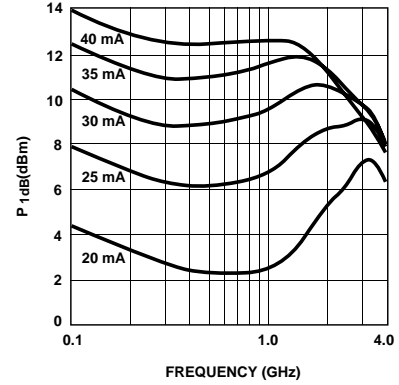

Figure 3. Typical P_{1dB} vs. Frequency at 25°C.

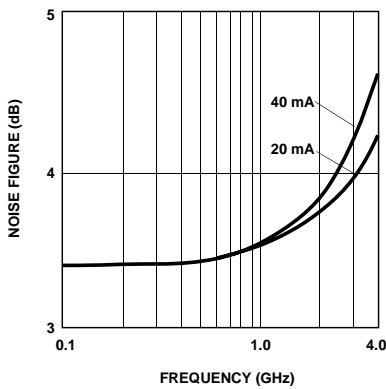

Figure 4. Noise Figure vs. Frequency at $I_D = 29$ mA.

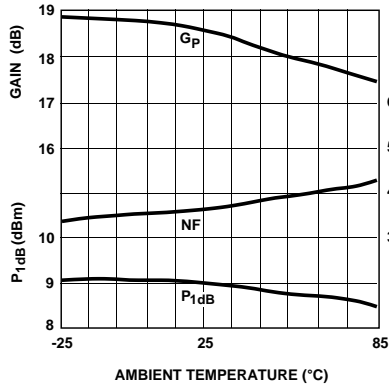

Figure 5. Power Gain, Noise Figure, and P_{1dB} vs. Temperature at 1 GHz and $I_D = 29$ mA.

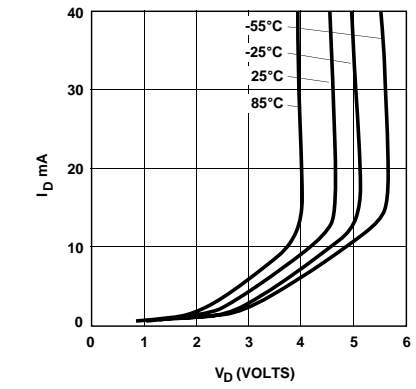

Figure 6. I_D vs. V_D at Four Temperatures.

Typical Scattering Parameters at $T_A = 25^\circ\text{C}$, for MSA-3111

$I_D = 29$ mA, $Z_0 = 50 \Omega$

Frequency (GHz)	S_{11}		S_{21}			S_{12}		S_{22}		
	Mag.	Ang.	(dB)	Mag.	Ang.	(dB)	Mag.	Ang.	Mag.	Ang.
0.1	0.05	3	24.4	16.53	167	-27.0	0.045	9	0.10	-23
0.2	0.06	4	24.0	15.83	156	-26.5	0.047	16	0.10	-41
0.3	0.07	-4	23.4	14.78	146	-26.0	0.050	23	0.10	-59
0.4	0.07	-8	22.7	13.59	136	-25.3	0.054	28	0.11	-72
0.5	0.07	-12	22.0	12.53	128	-24.6	0.059	33	0.11	-84
0.6	0.07	-18	21.1	11.41	121	-23.9	0.064	36	0.11	-94
0.7	0.07	-22	20.4	10.47	114	-23.1	0.070	39	0.11	-100
0.8	0.08	-26	19.7	9.63	109	-22.4	0.076	41	0.11	-106
0.9	0.08	-32	19.0	8.89	104	-21.7	0.082	42	0.11	-111
1.0	0.08	-35	18.4	8.27	99	-21.1	0.088	43	0.11	-114
1.5	0.08	-59	15.6	5.99	80	-18.5	0.118	44	0.11	-123
2.0	0.10	-79	13.4	4.69	65	-16.6	0.148	42	0.10	-122
2.5	0.10	-104	11.8	3.88	52	-15.2	0.175	38	0.11	-118
3.0	0.10	-129	10.4	3.31	39	-14.1	0.198	33	0.12	-114
3.5	0.12	-163	9.3	2.91	27	-13.2	0.219	28	0.12	-117
4.0	0.15	164	8.2	2.58	16	-12.6	0.236	23	0.13	-125
4.5	0.21	140	7.4	2.34	4	-12.1	0.250	18	0.13	-136
5.0	0.29	121	6.5	2.10	-7	-11.7	0.260	14	0.14	-148
5.5	0.36	109	5.6	1.90	-18	-11.3	0.271	10	0.17	-158
6.0	0.42	98	4.6	1.70	-28	-11.0	0.282	7	0.21	-165

Typical Performance for MSA-3135

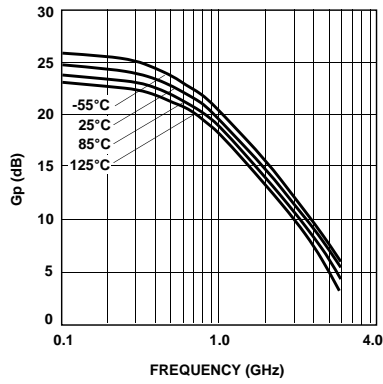

Figure 1. Power Gain vs. Frequency at Four Temperatures, $I_D = 29$ mA.

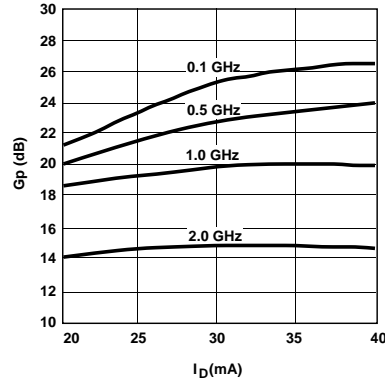

Figure 2. Power Gain vs. Current at 25°C.

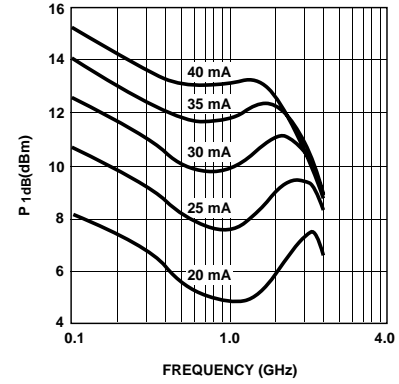

Figure 3. Typical P_{1dB} vs. Frequency at 25°C.

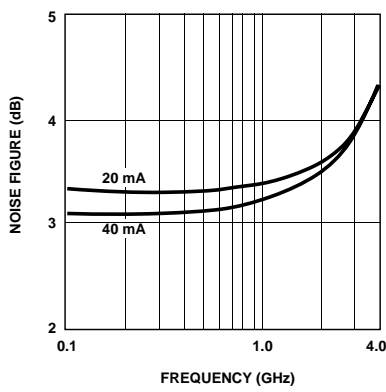

Figure 4. Noise Figure vs. Frequency at $I_D = 29$ mA.

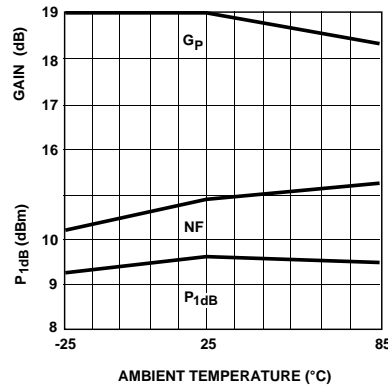

Figure 5. Power Gain, Noise Figure, and P_{1dB} vs. Temperature at 1 GHz and $I_D = 29$ mA.

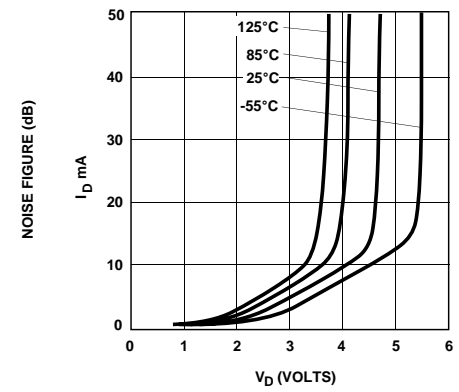

Figure 6. I_D vs. V_D at Four Temperatures.

Typical Scattering Parameters at $T_A = 25^\circ\text{C}$, for MSA-3135

$I_D = 29$ mA, $Z_0 = 50 \Omega$

Frequency (GHz)	S_{11}		S_{21}			S_{12}			S_{22}	
	Mag.	Ang.	(dB)	Mag.	Ang.	(dB)	Mag.	Ang.	Mag.	Ang.
0.1	0.05	1	24.7	17.11	169	-27.3	0.043	7	0.09	-19
0.2	0.06	2	24.4	16.52	158	-27.0	0.045	14	0.09	-37
0.3	0.07	-2	23.9	15.72	149	-26.5	0.047	20	0.09	-52
0.4	0.07	-7	23.4	14.77	139	-26.0	0.050	24	0.09	-67
0.5	0.07	-12	22.8	13.77	131	-25.4	0.054	29	0.09	-80
0.6	0.07	-21	22.1	12.79	124	-24.7	0.058	32	0.09	-92
0.7	0.07	-27	21.5	11.86	117	-24.1	0.063	34	0.09	-102
0.8	0.07	-33	20.9	11.03	111	-23.4	0.037	36	0.09	-111
0.9	0.08	-39	20.2	10.25	106	-22.8	0.072	38	0.09	-119
1.0	0.08	-44	19.6	9.55	101	-22.2	0.078	39	0.09	-127
1.5	0.08	-79	16.9	7.03	80	-19.7	0.104	39	0.10	-155
2.0	0.09	-116	14.8	5.52	63	-17.7	0.130	36	0.10	-171
2.5	0.11	-145	13.2	4.55	49	-16.3	0.153	31	0.09	176
3.0	0.15	-172	11.7	3.86	35	-15.2	0.175	25	0.10	162
3.5	0.19	166	10.5	3.34	22	-14.3	0.192	19	0.11	154
4.0	0.24	149	9.4	2.94	9	-13.7	0.207	13	0.12	152
4.5	0.29	134	8.3	2.61	-3	-13.2	0.219	7	0.13	148
5.0	0.35	120	7.4	2.34	-16	-12.8	0.228	1	0.15	141
5.5	0.41	107	6.4	2.08	-27	-12.5	0.236	-5	0.19	138
6.0	0.46	95	5.4	1.87	-39	-12.3	0.243	-10	0.24	137

Typical Performance for MSA-3185, MSA-3186

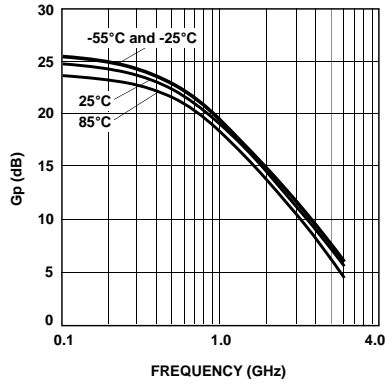

Figure 1. Power Gain vs. Frequency at Four Temperatures, $I_D = 29$ mA.

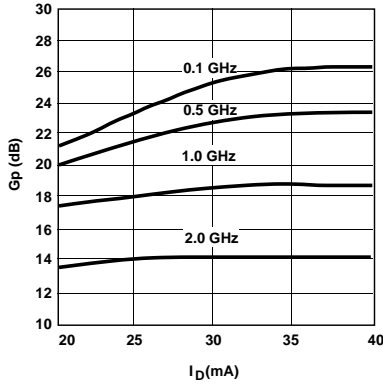

Figure 2. Power Gain vs. Current at 25°C .

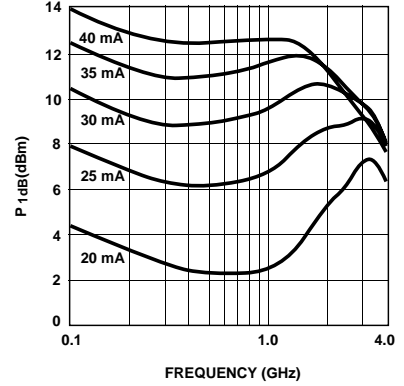

Figure 3. Typical P_{1dB} vs. Frequency at 25°C .

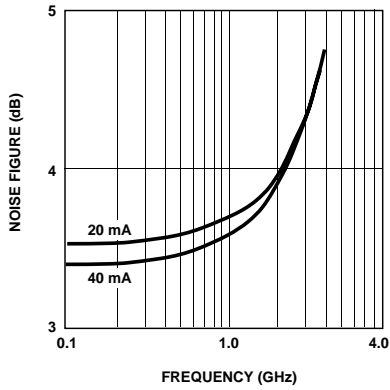

Figure 4. Noise Figure vs. Frequency at $I_D = 29$ mA.

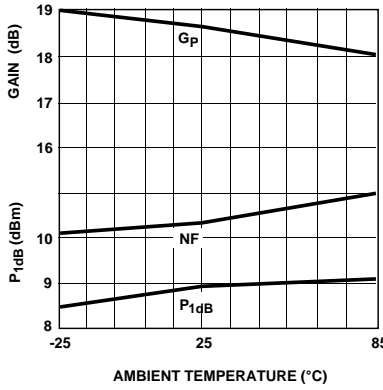

Figure 5. Power Gain, Noise Figure, and P_{1dB} vs. Temperature at 1 GHz and $I_D = 29$ mA.

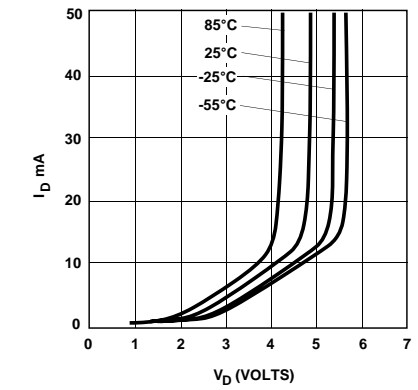

Figure 6. I_D vs. V_D at Four Temperatures.

Typical Scattering Parameters at $T_A = 25^\circ\text{C}$, for MSA-3185

$I_D = 29\text{ mA}$, $Z_0 = 50\ \Omega$

Frequency (GHz)	S_{11}		S_{21}			S_{12}			S_{22}	
	Mag.	Ang.	(dB)	Mag.	Ang.	(dB)	Mag.	Ang.	Mag.	Ang.
0.1	0.05	-3	24.6	17.04	167	-27.2	0.044	8	0.09	-32
0.2	0.04	-13	24.2	16.22	156	-26.8	0.046	16	0.09	-57
0.3	0.04	-22	23.6	15.18	145	-26.2	0.049	22	0.10	-76
0.4	0.06	-25	23.0	14.07	135	-25.5	0.053	27	0.11	-84
0.5	0.07	-27	22.2	12.95	127	-24.7	0.058	31	0.12	-91
0.6	0.07	-31	21.5	11.85	119	-24.0	0.063	34	0.12	-102
0.7	0.07	-33	20.7	10.85	112	-23.3	0.068	36	0.12	-110
0.8	0.06	-41	20.0	10.01	106	-22.6	0.074	38	0.13	-120
0.9	0.06	-45	19.3	9.27	101	-21.9	0.080	39	0.13	-126
1.0	0.06	-57	18.7	8.59	96	-21.3	0.086	40	0.13	-134
1.5	0.05	-89	15.9	6.23	74	-18.6	0.118	38	0.13	-157
2.0	0.05	-122	13.9	4.93	57	-16.6	0.147	33	0.12	-173
2.5	0.08	167	12.2	0.07	41	-15.1	0.175	26	0.16	-163
3.0	0.16	143	10.7	3.44	25	-14.1	0.197	17	0.18	-154
3.5	0.21	120	9.4	2.95	11	-13.5	0.212	9	0.24	-138
4.0	0.30	102	8.2	2.56	-3	-13.0	0.223	2	0.28	-124
4.5	0.40	93	7.1	2.26	-16	-12.7	0.231	-5	0.31	-114
5.0	0.51	87	6.1	2.03	-28	-12.4	0.240	-11	0.34	-109
5.5	0.61	80	5.2	1.82	-40	-12.2	0.247	-17	0.36	-105
6.0	0.67	72	4.3	1.64	-53	-12.0	0.251	-23	0.40	-101

Typical Scattering Parameters at $T_A = 25^\circ\text{C}$, for MSA-3186

$I_D = 29\text{ mA}$, $Z_0 = 50\ \Omega$

Frequency (GHz)	S_{11}		S_{21}			S_{12}			S_{22}	
	Mag.	Ang.	(dB)	Mag.	Ang.	(dB)	Mag.	Ang.	Mag.	Ang.
0.1	0.05	1	24.7	17.11	169	-27.3	0.043	7	0.09	-19
0.2	0.06	2	24.4	16.52	158	-27.0	0.045	14	0.09	-37
0.3	0.07	-2	23.9	15.72	149	-26.5	0.047	20	0.09	-52
0.4	0.07	-7	23.4	14.77	139	-26.0	0.050	24	0.09	-67
0.5	0.07	-12	22.8	13.77	131	-25.4	0.054	29	0.09	-80
0.6	0.07	-21	22.1	12.79	124	-24.7	0.058	32	0.09	-92
0.7	0.07	-27	21.5	11.86	117	-24.1	0.063	34	0.09	-102
0.8	0.07	-33	20.9	11.03	111	-23.4	0.037	36	0.09	-111
0.9	0.08	-39	20.2	10.25	106	-22.8	0.072	38	0.09	-119
1.0	0.08	-44	19.6	9.55	101	-22.2	0.078	39	0.09	-127
1.5	0.08	-79	16.9	7.03	80	-19.7	0.104	39	0.10	-155
2.0	0.09	-116	14.8	5.52	63	-17.7	0.130	36	0.10	-171
2.5	0.11	-145	13.2	4.55	49	-16.3	0.153	31	0.09	176
3.0	0.15	-171	11.7	3.86	35	-15.2	0.175	25	0.10	162
3.5	0.19	166	10.5	3.34	22	-14.3	0.192	19	0.11	154
4.0	0.24	149	9.4	2.94	9	-13.7	0.207	13	0.12	152
4.5	0.29	134	8.3	2.61	-3	-13.2	0.219	7	0.13	148
5.0	0.35	120	7.4	2.34	-16	-12.8	0.228	1	0.15	141
5.5	0.41	107	6.4	2.08	-27	-12.5	0.236	-5	0.19	138
6.0	0.46	95	5.4	1.87	-39	-12.3	0.243	-10	0.24	137

Tape and Reel Part Number Ordering Information

Part Number	Devices per Reel	Reel Size
MSA-3111-TR1	3000	7"
MSA-3186-TR1	1000	7"

Outline Drawings

SOT-143

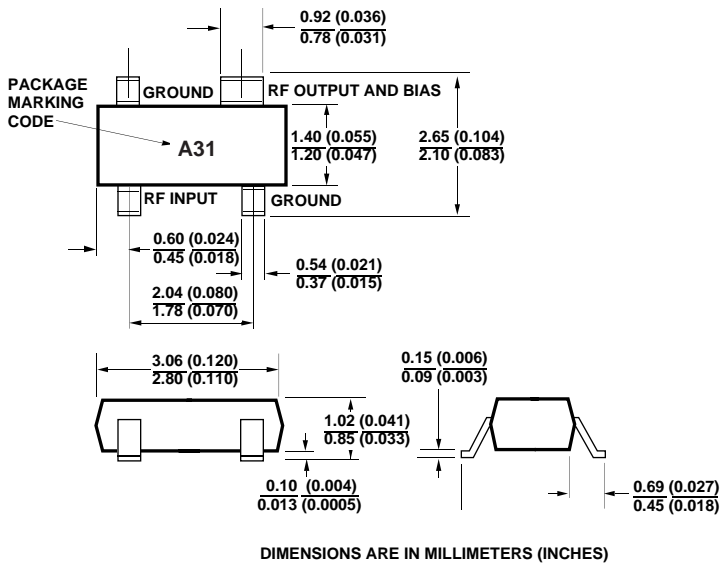

35

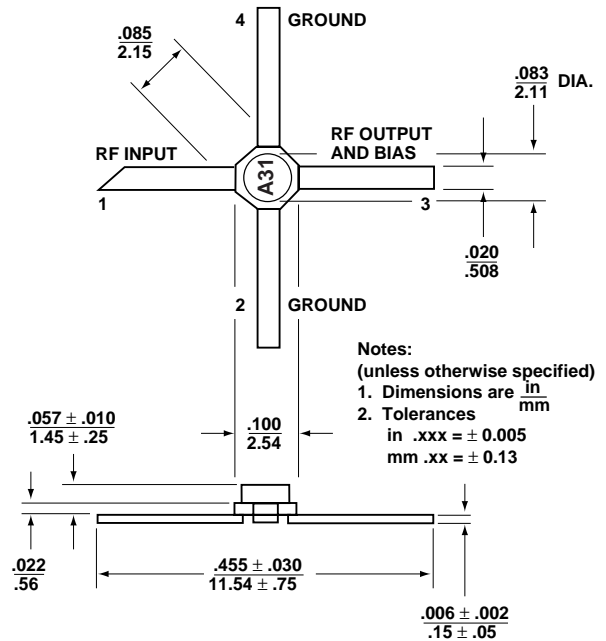

85

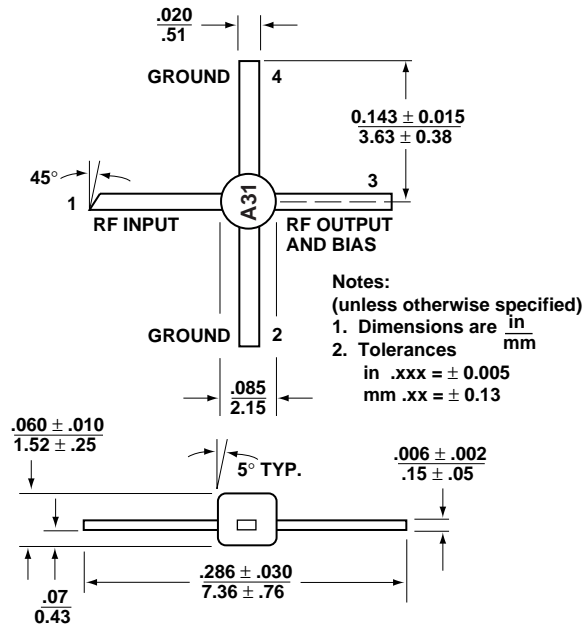

86

