

## 30–60 W DC/DC Power Modules 48 V Input Series

- Efficiency typ 86% (5 V) at full load
- Low profile 11.0 mm (0.43 in.)
- 1,500 Vdc isolation voltage (duals = 1,000 Vdc)
- MTBF >200 years at +75°C case temperature
- Rugged mechanical design and efficient thermal management, max +100°C case temperature
- EMI measured according to EN 55 022 and FCC part 15J



The PKG series of DC/DC Power Modules are members of the EriPower™ range of low profile DC/DC converters for distributed power architectures in 48/60 VDC power systems. They provide up to 60W in single and dual output versions. Utilizing the standard EriPower™ PKA/PKE pin-out with an even smaller footprint, the power density is 20 W/cu.in. The PKG units can be used as on-board distributed power modules, or serve as building blocks for more centralized power boards. The high efficiency makes it possible to operate over a wide temperature range without any extra heatsinks. At forced convection cooling >200 lfm (1 m/s), the PKG units can deliver full power without heatsinks up to +65°C ambient. With derated output power it can also operate in

temperature controlled environments with non-forced convection cooling. By adding external heatsinking, the temperature range can be extended even further. Thanks to its peak power capability, the PKG series is ideal for applications where max power is only required during short durations e.g. in disc drives. The PKG series uses ceramic sub-strates with plated copper in order to achieve good thermal management, low voltage drops, and a high efficiency. These products are manufactured using highly automated manufacturing lines with a world-class quality commitment and a five-year warranty. Ericsson Microelectronics AB has been an ISO 9001 certified supplier since 1991. *For a complete product program please reference the back cover.*

# General

## Absolute Maximum Ratings

Characteristics		min	max	Unit
T <sub>C</sub>	Case temperature @ max output power	-45	+100	°C
T <sub>S</sub>	Storage temperature	-55	+125	°C
V <sub>I</sub>	Input voltage	-0.5	+80	V dc
V <sub>ISO</sub>	Isolation voltage (input to output test voltage)	single output 1,500 dual output 1,000		V dc
V <sub>RC</sub>	Remote control voltage pin 1	-10	+10	V dc
V <sub>adj</sub>	Output adjust voltage pin 10	-10	+10	V dc

Stress in excess of Absolute Maximum Ratings may cause permanent damage. Absolute Maximum Ratings, sometimes referred to as no destruction limits, are normally tested with one parameter at a time exceeding the limits of Output data or Electrical Characteristics. If exposed to stress above these limits, function and performance may degrade in an unspecified manner.

## Input T<sub>C</sub> < T<sub>C</sub> max

Characteristics		Conditions	min	typ	max	Unit
V <sub>I</sub>	Input voltage range <sup>1)</sup>		38		72	V
V <sub>Ioff</sub>	Turn-off input voltage	(See Operating Information)		32		V
V <sub>Ion</sub>	Turn-on input voltage	(See Operating Information)		33		V
r <sub>Irush</sub>	Equivalent inrush current resistance			30		mΩ
C <sub>I</sub>	Input capacitance			1.8		μF
P <sub>Ii</sub>	Input idling power	I <sub>O</sub> =0, T <sub>C</sub> = -30...+90°C		1.5	2.0	W
P <sub>RC</sub>	Input stand-by current	V <sub>I</sub> = 53 V, T <sub>C</sub> = +25°C RC connected to pin 4		1.0		W

## Environmental Characteristics

Characteristics	Test procedure & conditions		
Vibration (Sinusoidal)	IEC 68-2-6 F <sub>c</sub>	Frequency Amplitude Acceleration Number of cycles	10...500 Hz 0.75 mm 10 g 10 in each axis
Random vibration	IEC 68-2-34 E <sub>d</sub>	Frequency Acceleration density spectrum Duration Reproducibility	10...500 Hz 0.5 g <sup>2</sup> /Hz 10 min in 3 directions medium (IEC 62-2-36)
Shock (Half sinus)	IEC 68-2-27 E <sub>a</sub>	Peak acceleration Shock duration	200 g 3 ms
Temperature change	IEC 68-2-14 N <sub>a</sub>	Temperature Number of cycles	-40°C...+125°C 100
Accelerated damp heat	IEC 68-2-3 C <sub>a</sub> with bias	Temperature Humidity Duration	85°C 85% RH 1000 hours
Solder resistability	IEC 68-2-20 T <sub>b</sub> 1A	Temperature, solder Duration	260°C 10...13 s
Resistance to cleaning solvents	IEC 68-2-45 XA Method 1	Water Isopropyl alcohol Terpens Method	+55 ±5°C +35 ±5°C +35 ±5°C with rubbing

## Safety

The PKG 4000 I Series DC/DC power modules are designed in accordance with EN 60950 *Safety of information technology equipment including electrical business equipment* and certified by SEMKO. The isolation is an operational insulation in accordance with EN 60950.

The PKG DC/DC power modules are recognized by UL and meet the applicable requirements in UL 1950 *Safety of information technology equipment*, the applicable Canadian safety requirements and UL 1012 *Standard for power supplies*.

The DC/DC power module shall be installed in an end-use equipment and is intended to be supplied by isolated secondary circuitry and shall be installed in compliance with the requirements of the ultimate application.

When the supply to the DC/DC power module meets all the requirements for SELV (<60Vdc), the output is considered to remain within SELV limits (level 3). If connected to a 60 V DC power system reinforced insulation must be provided in the power supply that isolates the input from the ac mains. Single fault testing in the power supply must be performed in combination with the DC/DC power module to demonstrate that the output meets the requirement for SELV. One pole of the input and one pole of the output is to be grounded or both are to be kept floating.

The terminal pins are only intended for connection to mating connectors of internal wiring inside the end-use equipment.

These DC/DC power modules may be used in telephone equipment in accordance with paragraph 34 A.1 of UL 1459 (Standard for Telephone Equipment, second edition).

The isolation voltage is a galvanic isolation and is verified in an electric strength test. Test voltage between input and output and between case and output is 1,500 V dc (duals = 1,000 V dc) for 60 s. In production the test duration may be decreased to 1 s.

The capacitor between input and output has a value of 4.7 nF (duals = 22 nF) and the leakage current is less than 1μA @ 50 Vdc.

Flammability ratings of the terminal support and internal plastic construction details meets UL 94V-0.

### Note:

<sup>1)</sup>The input voltage range 38...72 V meets the requirements in the European Telecom Standard prETS 300 132-2 for Normal input voltage range in 48 V and 60 V DC power systems, -40.5...-57.0 V and -50.0...-72.0 V respectively. At input voltages exceeding 72 V (abnormal voltage) the power loss will be higher than at normal input voltage and T<sub>C</sub> must be limited to max +90°C. Absolute max continuous input voltage is 80 V dc. Output characteristics will be marginally affected at input voltages exceeding 72 V.

## Mechanical Data

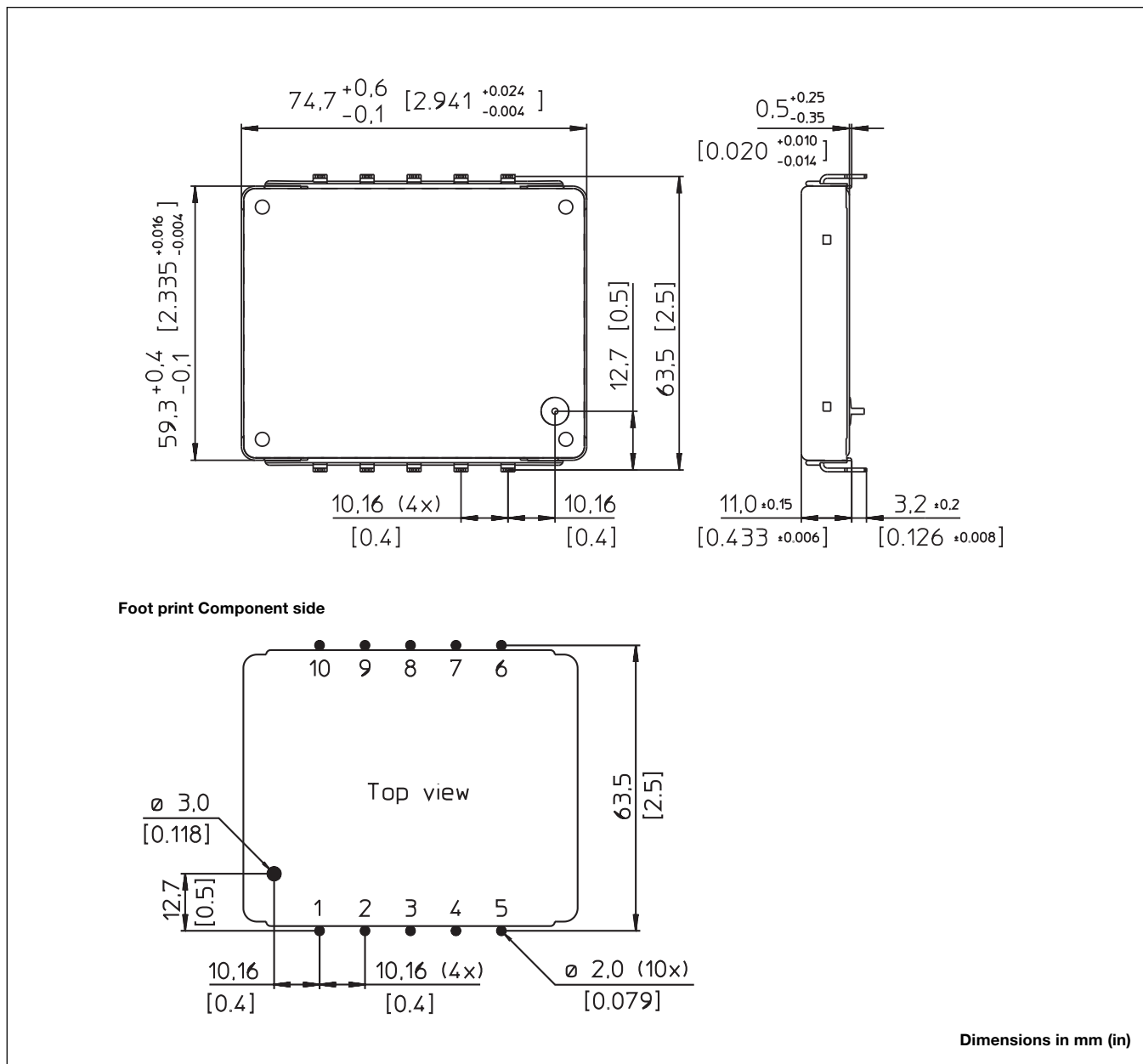

## Connections

Pin	Designation	Function
1	RC	Remote control. To turn-on and turn-off the output and to set the turn-off input voltage threshold.
2	TOA	Turn-off input voltage adjust (see Operating information).
3	+In	Positive input. Connected to case.
4	-In	Negative input.
5	NC	Not connected.
6	-Out 2	Negative output 2.
7	+Out 2	Positive output 2.
8	-Out 1	Negative output 1.
9	+Out 1	Positive output 1.
10	V <sub>adj</sub>	Output voltage adjust.

## Weight

Maximum 75 g (2.66 oz).

## Case

Blue anodized aluminium casing with embedded tin plated copper pins.

# Thermal Data

## Two-parameter model

Power dissipation is generated in the components mounted on the ceramic substrate. The thermal properties of the PKG power module are determined by thermal conduction in the connected pins and thermal convection from the substrate via the case.

The two-parameter model characterizes the thermal properties of the PKG power module and the equation below can be used for thermal design purposes if detailed information is needed. The values are given for a module mounted on a printed board assembly (PBA).

Note that the thermal resistance between the substrate and the air,  $R_{th\ sub-A}$  is strongly dependent on the air velocity.

$$T_{sub} = P_d \times R_{th\ sub-P} \times R_{th\ sub-A} / (R_{th\ sub-P} + R_{th\ sub-A}) + (T_P - T_A) \times R_{th\ sub-A} / (R_{th\ sub-P} + R_{th\ sub-A}) + T_A$$

Where:

- $P_d$  : dissipated power, calculated as  $P_O \times (1/\eta - 1)$
- $T_{sub}$  : max average substrate temperature,  $\approx T_{Cmax}$
- $T_A$  : ambient air temperature at the lower side of the power module
- $T_P$  : average pin temperature at the PB solder joint
- $R_{th\ sub-P}$  : thermal resistance from  $T_{sub}$  to the pins
- $R_{th\ sub-A}$  : thermal resistance from  $T_{sub}$  to  $T_A$
- $v$  : velocity of ambient air.

Air velocity in free convection is 0.2–0.3 m/s (40-60 lfm).

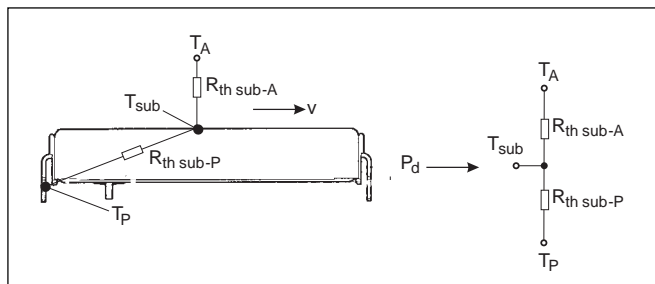
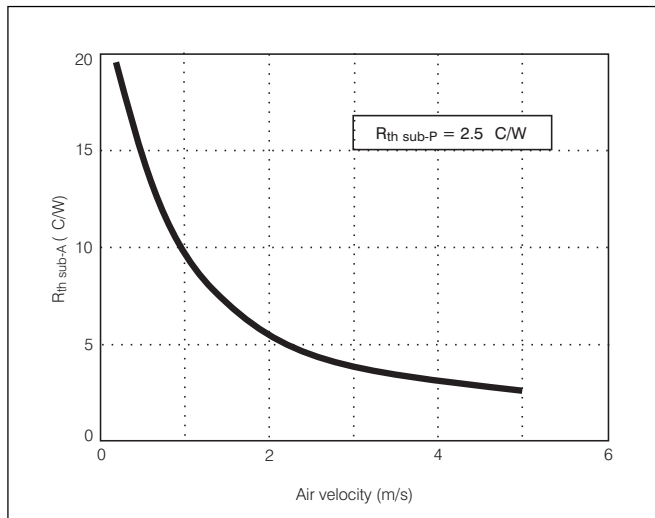

## Over Temperature Protection (OTP)

The PKG DC/DC power modules have an internal over temperature protection circuit. If the case temperature exceeds min +115 °C the power module will go in to OTP-mode. As long as the case temperature exceeds min +115 °C the power module will operate in OTP-mode.

During OTP-mode the output voltage pulsates between zero and nominal output voltage, which reduces the power loss inside the power module. The PKG DC/DC power module will automatically resume normal operation when the temperature decreases below min +115 °C.

# Electrical Data

## Fundamental circuit diagrams

### Single output

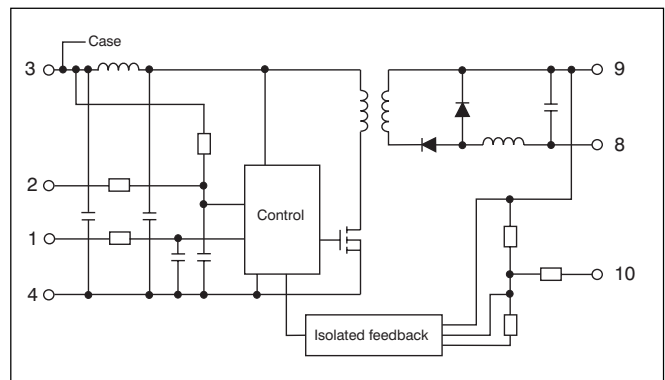

### Dual output

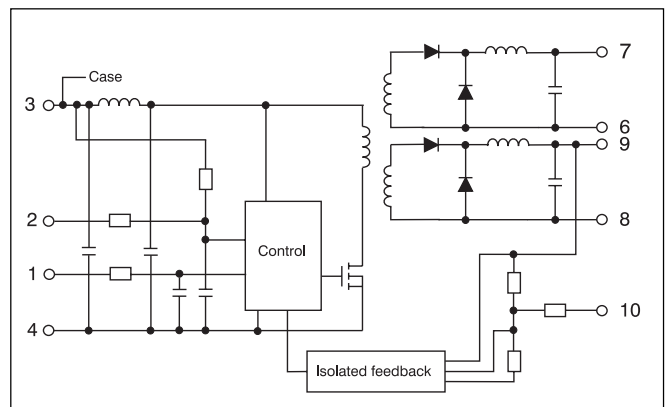

# PKG 4310 PI

$T_C = -30...+90^\circ\text{C}$ ,  $V_I = 38...72\text{V}$  unless otherwise specified.

## Output

Characteristics		Conditions		Output 1			Unit
				min	typ	max	
$V_{O_i}$	Output voltage initial setting and accuracy	$T_C = +25^\circ\text{C}$ , $I_O = 14.5\text{ A}$ , $V_I = 53\text{ V}$		2.07	2.10	2.13	V
	Output adjust range <sup>1)</sup>			1.90		2.30	V
$V_O$	Output voltage tolerance band	Long term drift included	$I_O = 0.1...1.0 \times I_{O_{\max}}$	2.03		2.17	V
	Idling voltage	$I_O = 0\text{ A}$				3.5	V
	Line regulation	$I_O = I_{O_{\max}}$	$V_I = 38...60\text{ V}$	2			mV
			$V_I = 50...72\text{ V}$	2			
	Load regulation	$I_O = 0.1...1.0 \times I_{O_{\max}}$ , $V_I = 53\text{ V}$		30			mV
$t_{tr}$	Load transient recovery time	$I_O = 0.1...1.0 \times I_{O_{\max}}$ , $V_I = 53\text{ V}$ load step = $0.5 \times I_{O_{\max}}$		100			$\mu\text{s}$
$V_{tr}$	Load transient voltage			+130			mV
				-210			mV
$T_{\text{coeff}}$	Temperature coefficient <sup>2)</sup>	$I_O = I_{O_{\max}}$ , $T_C < T_{C_{\max}}$		see PKG 4310 PI Temperature characteristics			
$t_r$	Ramp-up time	$I_O = 0.1...1.0 \times I_{O_{\max}}$ $V_I = 53\text{ V}$	$0.1...0.9 \times V_O$	10			ms
$t_s$	Start-up time		From $V_I$ connection to $V_O = 0.9 \times V_{O_i}$	30			ms
$I_O$	Output current			0		14.5	A
$P_{O_{\max}}$	Max output power <sup>3)</sup>	Calculated value		30			W
$I_{\text{lim}}$	Current limiting threshold	$T_C < T_{C_{\max}}$		16.2			A
$I_{sc}$	Short circuit current	$V_O = 0.2...0.5\text{ V}$ , $T_A = 25^\circ\text{C}$		18			A
$V_{O_{ac}}$	Output ripple	$I_O = I_{O_{\max}}$	20 Hz ... 5 MHz	60		100	mV <sub>p-p</sub>
SVR	Supply voltage rejection (ac)	f = 100 Hz sine wave, 1 V <sub>p-p</sub> , $V_I = 53\text{ V}$ (SVR = $20 \log(1 V_{p-p}/V_{O_{p-p}})$ )		56			dB
OVP	Over voltage protection	$I_O > 0.1 \times I_{O_{\max}}$		2.6			V

<sup>1)</sup> See Operating information.

<sup>2)</sup> Temperature coefficient is positive at low temperatures and negative at high temperatures.

<sup>3)</sup> See also Typical Characteristics, Power derating.

## Miscellaneous

Characteristics		Conditions	min	typ	max	Unit
$\eta$	Efficiency	$I_O = I_{O_{\max}}$ , $V_I = 53\text{ V}$		75		%
$P_d$	Power dissipation	$I_O = I_{O_{\max}}$ , $V_I = 53\text{ V}$		10		W

# PKG 4319 PI

$T_C = -30...+90^{\circ}\text{C}$ ,  $V_I = 38 \dots 72\text{V}$  unless otherwise specified.

## Output

Characteristics		Conditions		Output 1			Unit
				min	typ	max	
$V_{O_i}$	Output voltage initial setting and accuracy	$T_C = +25^{\circ}\text{C}$ , $I_O = 15\text{ A}$ , $V_I = 53\text{ V}$		2.49	2.51	2.53	V
	Output adjust range <sup>1)</sup>			2.25		2.75	
$V_O$	Output voltage tolerance band	Long term drift included	$I_O = 0.1 \dots 1.0 \times I_{O_{\text{max}}}$	2.43		2.57	V
	Idling voltage	$I_O = 0\text{ A}$		3.0		V	
	Line regulation	$I_O = I_{O_{\text{max}}}$	$V_I = 38 \dots 60\text{ V}$	5		mV	
			$V_I = 50 \dots 72\text{ V}$	5			
	Load regulation	$I_O = 0.1 \dots 1.0 \times I_{O_{\text{max}}}$ , $V_I = 53\text{ V}$		20		mV	
$t_{\text{tr}}$	Load transient recovery time	$I_O = 0.1 \dots 1.0 \times I_{O_{\text{max}}}$ , $V_I = 53\text{ V}$ load step = $0.5 \times I_{O_{\text{max}}}$		100		$\mu\text{s}$	
$V_{\text{tr}}$	Load transient voltage			+250		mV	
				-500		mV	
$T_{\text{coeff}}$	Temperature coefficient <sup>2)</sup>	$I_O = I_{O_{\text{max}}}$ , $T_C < T_{C_{\text{max}}}$		see PKG 4319 PI Temperature characteristics			
$t_r$	Ramp-up time	$I_O = 0.1 \dots 1.0 \times I_{O_{\text{max}}}$ $V_I = 53\text{ V}$	$0.1 \dots 0.9 \times V_O$	30		ms	
$t_s$	Start-up time		From $V_I$ connection to $V_O = 0.9 \times V_{O_i}$	60		ms	
$I_O$	Output current			0	15		A
$P_{O_{\text{max}}}$	Max output power <sup>3)</sup>	Calculated value		38		W	
$I_{\text{lim}}$	Current limiting threshold	$T_C < T_{C_{\text{max}}}$		15.3		A	
$I_{\text{sc}}$	Short circuit current	$V_O = 0.2 \dots 0.5\text{ V}$ , $T_A = 25^{\circ}\text{C}$ , $R_{\text{SC}} > 25\text{ m}\Omega$		22		A	
$V_{O_{\text{ac}}}$	Output ripple	$I_O = I_{O_{\text{max}}}$	20 Hz...5 MHz	60	100		mV <sub>p-p</sub>
SVR	Supply voltage rejection (ac)	$f = 100\text{ Hz}$ sine wave, $1\text{ V}_{p-p}$ , $V_I = 53\text{ V}$ ( $\text{SVR} = 20 \log(1\text{ V}_{p-p}/V_{O_{p-p}})$ )		47		dB	
OVP	Over voltage protection	$I_O > 0.1 \times I_{O_{\text{max}}}$		3.5		V	

<sup>1)</sup> See Operating information.

<sup>2)</sup> Temperature coefficient is positive at low temperatures and negative at high temperatures.

<sup>3)</sup> See also Typical Characteristics, Power derating.

## Miscellaneous

Characteristics		Conditions	min	typ	max	Unit
$\eta$	Efficiency	$I_O = I_{O_{\text{max}}}$ , $V_I = 53\text{ V}$		78		%
$P_d$	Power dissipation	$I_O = I_{O_{\text{max}}}$ , $V_I = 53\text{ V}$		10.5		W

# PKG 4410 PI

$T_C = -30...+90^{\circ}\text{C}$ ,  $V_I = 38...72\text{V}$  unless otherwise specified.

## Output

Characteristics		Conditions		Output 1			Unit
				min	typ	max	
$V_{O_i}$	Output voltage initial setting and accuracy	$T_C = +25^{\circ}\text{C}$ , $I_O = 14\text{ A}$ , $V_I = 53\text{ V}$		3.28	3.30	3.32	V
	Output adjust range <sup>1)</sup>			2.80		3.65	V
$V_O$	Output voltage tolerance band	Long term drift included	$I_O = 0.1...1.0 \times I_{O_{\text{max}}}$	3.10		3.40	V
	Idling voltage	$I_O = 0\text{ A}$				4.0	V
	Line regulation	$I_O = I_{O_{\text{max}}}$	$V_I = 38...60\text{ V}$	3			mV
			$V_I = 50...72\text{ V}$	3			
	Load regulation	$I_O = 0.1...1.0 \times I_{O_{\text{max}}}$ , $V_I = 53\text{ V}$		35			mV
$t_{\text{tr}}$	Load transient recovery time	$I_O = 0.1...1.0 \times I_{O_{\text{max}}}$ , $V_I = 53\text{ V}$ load step = $0.5 \times I_{O_{\text{max}}}$		100			$\mu\text{s}$
$V_{\text{tr}}$	Load transient voltage			+200			mV
				-330			mV
$T_{\text{coeff}}$	Temperature coefficient <sup>2)</sup>	$I_O = I_{O_{\text{max}}}$ , $T_C < T_{C_{\text{max}}}$		see PKG 4410 PI Temperature characteristics			
$t_r$	Ramp-up time	$I_O = 0.1...1.0 \times I_{O_{\text{max}}}$ $V_I = 53\text{ V}$	$0.1...0.9 \times V_O$	10			ms
$t_s$	Start-up time		From $V_I$ connection to $V_O = 0.9 \times V_{O_i}$	30			ms
$I_O$	Output current			0		14	A
$P_{O_{\text{max}}}$	Max output power <sup>3)</sup>	Calculated value		46			W
$I_{\text{lim}}$	Current limiting threshold	$T_C < T_{C_{\text{max}}}$		15.4			A
$I_{\text{sc}}$	Short circuit current	$V_O = 0.2...0.5\text{ V}$ , $T_A = 25^{\circ}\text{C}$		18			A
$V_{O_{\text{ac}}}$	Output ripple	$I_O = I_{O_{\text{max}}}$	20 Hz ... 5 MHz	60		100	mV <sub>p-p</sub>
SVR	Supply voltage rejection (ac)	$f = 100\text{ Hz}$ sine wave, $1\text{ V}_{p-p}$ , $V_I = 53\text{ V}$ (SVR = $20 \log(1\text{ V}_{p-p}/V_{O_{p-p}})$ )		53			dB
OVP	Over voltage protection	$I_O > 0.1 \times I_{O_{\text{max}}}$		4			V

<sup>1)</sup> See Operating information.

<sup>2)</sup> Temperature coefficient is positive at low temperatures and negative at high temperatures.

<sup>3)</sup> See also Typical Characteristics, Power derating.

## Miscellaneous

Characteristics		Conditions	min	typ	max	Unit
$\eta$	Efficiency	$I_O = I_{O_{\text{max}}}$ , $V_I = 53\text{ V}$		81		%
$P_d$	Power dissipation	$I_O = I_{O_{\text{max}}}$ , $V_I = 53\text{ V}$		11		W

# PKG 4611 PI

$T_C = -30 \dots +90^\circ\text{C}$ ,  $V_I = 38 \dots 72\text{V}$  unless otherwise specified.

## Output

Characteristics		Conditions		Output 1			Unit
				min	typ	max	
$V_{O_i}$	Output voltage initial setting and accuracy	$T_C = +25^\circ\text{C}$ , $I_O = 12\text{A}$ , $V_I = 53\text{V}$		5.12	5.15	5.18	V
	Output adjust range <sup>1)</sup>			4.65		5.65	V
$V_O$	Output voltage tolerance band	Long term drift included	$I_O = 0.1 \dots 1.0 \times I_{O_{\text{max}}}$	5.00		5.20	V
	Idling voltage	$I_O = 0\text{A}$				5.6	V
	Line regulation	$I_O = I_{O_{\text{max}}}$	$V_I = 38 \dots 60\text{V}$	5		mV	
			$V_I = 50 \dots 72\text{V}$	5			
	Load regulation	$I_O = 0.1 \dots 1.0 \times I_{O_{\text{max}}}$ , $V_I = 53\text{V}$		50		mV	
$t_{\text{tr}}$	Load transient recovery time	$I_O = 0.1 \dots 1.0 \times I_{O_{\text{max}}}$ , $V_I = 53\text{V}$ load step = $0.5 \times I_{O_{\text{max}}}$		100		$\mu\text{s}$	
$V_{\text{tr}}$	Load transient voltage			+350		mV	
				-500		mV	
$T_{\text{coeff}}$	Temperature coefficient <sup>2)</sup>	$I_O = I_{O_{\text{max}}}$ , $T_C < T_{C_{\text{max}}}$		see PKG 4611 PI Temperature characteristics			
$t_r$	Ramp-up time	$I_O = 0.1 \dots 1.0 \times I_{O_{\text{max}}}$ $V_I = 53\text{V}$	$0.1 \dots 0.9 \times V_O$	10		ms	
$t_s$	Start-up time		From $V_I$ connection to $V_O = 0.9 \times V_{O_i}$	30		ms	
$I_O$	Output current			0		12	A
$P_{O_{\text{max}}}$	Max output power <sup>3)</sup>	Calculated value		60		W	
$I_{\text{lim}}$	Current limiting threshold	$T_C < T_{C_{\text{max}}}$		12.1		A	
$I_{\text{sc}}$	Short circuit current	$V_O = 0.2 \dots 0.5\text{V}$ , $T_A = 25^\circ\text{C}$		17		A	
$V_{O_{\text{ac}}}$	Output ripple	$I_O = I_{O_{\text{max}}}$	20 Hz ... 5 MHz	60		100	mV <sub>p-p</sub>
SVR	Supply voltage rejection (ac)	$f = 100\text{Hz}$ sine wave, $1\text{V}_{p-p}$ , $V_I = 53\text{V}$ ( $\text{SVR} = 20 \log(1\text{V}_{p-p}/V_{O_{p-p}})$ )		50		dB	
OVP	Over voltage protection	$I_O > 0.1 \times I_{O_{\text{max}}}$		6		V	

<sup>1)</sup> See Operating information.

<sup>2)</sup> Temperature coefficient is positive at low temperatures and negative at high temperatures.

<sup>3)</sup> See also Typical Characteristics, Power derating.

## Miscellaneous

Characteristics		Conditions	min	typ	max	Unit
$\eta$	Efficiency	$I_O = I_{O_{\text{max}}}$ , $V_I = 53\text{V}$		86		%
$P_d$	Power dissipation	$I_O = I_{O_{\text{max}}}$ , $V_I = 53\text{V}$		10		W



# PKG 4617 PIOA

$T_C = -30 \dots +90^\circ\text{C}$ ,  $V_I = 38 \dots 72\text{V}$  unless otherwise specified.

## Output

Characteristics		Conditions		Output 1			Unit
				min	typ	max	
$V_{OI}$	Output voltage initial setting and accuracy	$T_C = +25^\circ\text{C}$ , $I_O = 10\text{A}$ , $V_I = 53\text{V}$		6.19	6.22	6.25	V
	Output adjust range <sup>1)</sup>			5.0		7.7	V
$V_O$	Output voltage tolerance band	Long term drift included	$I_O = 0.1 \dots 1.0 \times I_{Omax}$	6.00		6.40	V
	Idling voltage	$I_O = 0\text{A}$				7.5	V
	Line regulation	$I_O = I_{Omax}$	$V_I = 38 \dots 60\text{V}$	5			mV
			$V_I = 50 \dots 72\text{V}$	5			
	Load regulation	$I_O = 0.1 \dots 1.0 \times I_{Omax}$ , $V_I = 53\text{V}$		50			mV
$t_{tr}$	Load transient recovery time	$I_O = 0.1 \dots 1.0 \times I_{Omax}$ , $V_I = 53\text{V}$ load step = $0.5 \times I_{Omax}$		100			$\mu\text{s}$
$V_{tr}$	Load transient voltage			+200			
				-400			
$T_{coeff}$	Temperature coefficient <sup>2)</sup>	$I_O = I_{Omax}$ , $T_C < T_{Cmax}$		see PKG 4617 PIOA Temperature characteristics			
$t_r$	Ramp-up time	$I_O = 0.1 \dots 1.0 \times I_{Omax}$ $V_I = 53\text{V}$	$0.1 \dots 0.9 \times V_O$	15			ms
$t_s$	Start-up time		From $V_I$ connection to $V_O = 0.9 \times V_{OI}$	25			ms
$I_O$	Output current			0		10	A
$P_{Omax}$	Max output power <sup>3)</sup>	Calculated value		60			W
$I_{lim}$	Current limiting threshold	$T_C < T_{Cmax}$		11.6			A
$I_{sc}$	Short circuit current	$V_O = 0.2 \dots 0.5\text{V}$ , $T_A = 25^\circ\text{C}$		15			A
$V_{Oac}$	Output ripple	$I_O = I_{Omax}$	20 Hz ... 5 MHz	60		100	mV <sub>p-p</sub>
SVR	Supply voltage rejection (ac)	$f = 100\text{Hz}$ sine wave, $1\text{V}_{p-p}$ , $V_I = 53\text{V}$ ( $SVR = 20 \log(1 \text{V}_{p-p}/V_{O-p-p})$ )		50			dB
OVP	Over voltage protection	$I_O > 0.1 \times I_{Omax}$		8			V

<sup>1)</sup> See Operating information.

<sup>2)</sup> Temperature coefficient is positive at low temperatures and negative at high temperatures.

## Miscellaneous

Characteristics		Conditions	min	typ	max	Unit
$\eta$	Efficiency	$I_O = I_{Omax}$ , $V_I = 53\text{V}$		86		%
$P_d$	Power dissipation	$I_O = I_{Omax}$ , $V_I = 53\text{V}$		10		W

# PKG 4428 PI

$T_C = -30 \dots +90^\circ\text{C}$ ,  $V_I = 38 \dots 72\text{V}$  unless otherwise specified.  $I_{O1\text{ nom}} = 6.0\text{ A}$ ,  $I_{O2\text{ nom}} = 4.0\text{ A}$ .

## Output

Characteristics		Conditions		Output 1			Output 2			Unit
				min	typ	max	min	typ	max	
$V_{O_i}$	Output voltage initial setting and accuracy	$T_C = +25^\circ\text{C}$ , $I_O = I_{O\text{ nom}}$ , $V_I = 53\text{ V}$		3.27	3.30	3.33	5.10	5.27	5.40	V
	Output adjust range <sup>1)</sup>			2.90	3.70		4.60	5.90		V
$V_O$	Output voltage tolerance band	Long term drift included	$I_O = 0.2 \dots 1.0 \times I_{O\text{ nom}}$ $I_{O1} = 1.5 \times I_{O2}$	3.10	3.40		4.90	5.40		V
	Idling voltage	$I_O = 0\text{ A}$		4.0			7.0		V	
	Line regulation	$I_O = I_{O\text{ nom}}$	$V_I = 38 \dots 60\text{ V}$	5			15		mV	
			$V_I = 50 \dots 72\text{ V}$	5			15			
	Load regulation	$I_{O1} = 0.1 \dots 1.0 \times I_{O1\text{ nom}}$ , $I_{O2} = I_{O2\text{ nom}}$ , $V_I = 53\text{ V}$		15					mV	
$t_{tr}$	Load transient recovery time	$I_O = 0.1 \dots 1.0 \times I_{O1\text{ nom}}$ , $V_I = 53\text{ V}$ load step = $0.5 \times I_{O1\text{ nom}}$ , $I_{O2} = I_{O2\text{ nom}}$		100			100		$\mu\text{s}$	
$V_{tr}$	Load transient voltage			+150			+150		mV	
				-200			-200		mV	
$T_{\text{coeff}}$	Temperature coefficient <sup>2)</sup>	$I_O = I_{O\text{ nom}}$ , $T_C < T_{C\text{ max}}$		see PKG 4428 PI Temperature characteristics						
$t_r$	Ramp-up time	$I_O = 0.1 \dots 1.0 \times I_{O\text{ max}}$ $V_I = 53\text{ V}$	$0.1 \dots 0.9 \times V_O$	10			10		ms	
$t_s$	Start-up time		From $V_I$ connection to $V_O = 0.9 \times V_{O_i}$	15			15		ms	
$I_O$	Output current			0	9.6		0 <sup>4)</sup>	6.4	A	
$P_{O\text{ max}}$	Max total output power <sup>3)</sup>	Calculated value		min 40					W	
$I_{\text{lim}}$	Current limiting threshold	$T_C < T_{C\text{ max}}$		min $1.02 \times P_{O\text{ max}}$ <sup>5)</sup>						
$I_{sc}$	Short circuit current	$V_O = 0.2 \dots 0.5\text{ V}$ , $T_A = 25^\circ\text{C}$ , $R_{SC} > 0.1\ \Omega$		15					A	
$V_{O\text{ ac}}$	Output ripple	$I_O = I_{O\text{ nom}}$	20 Hz...5 MHz	100	150		100	150	mV <sub>p-p</sub>	
SVR	Supply voltage rejection (ac)	$f = 100\text{ Hz}$ sine wave, $1\text{ V}_{p-p}$ , $V_I = 53\text{ V}$ (SVR = $20 \log(1\text{ V}_{p-p}/V_{O\text{ p-p}})$ )		60			60		dB	
OVP	Over voltage protection	$I_O > 0.1 \times I_{O\text{ max}}$		4					V	

<sup>1)</sup> See Operating information.

<sup>2)</sup> Temperature coefficient is positive at low temperatures and negative at high temperatures.

<sup>3)</sup> See also Typical Characteristics, Power derating.

<sup>4)</sup> At full load on output 1 output 2 must have min 0.6 A load.

<sup>5)</sup>  $I_{\text{lim}}$  on each output is set by the total load.

## Miscellaneous

Characteristics		Conditions	min	typ	max	Unit
$\eta$	Efficiency	$I_O = I_{O\text{ nom}}$ , $V_I = 53\text{ V}$		84		%
$P_d$	Power dissipation	$I_O = I_{O\text{ nom}}$ , $V_I = 53\text{ V}$		7.6		W

# PKG 4623 PI

$T_C = -30 \dots +90^\circ\text{C}$ ,  $V_I = 38 \dots 72\text{V}$  unless otherwise specified.  $I_{O1 \text{ nom}} = 2.5 \text{ A}$ ,  $I_{O2 \text{ nom}} = 2.5 \text{ A}$ .

## Output

Characteristics		Conditions		Output 1			Output 2			Unit
				min	typ	max	min	typ	max	
$V_{O1}$	Output voltage initial setting and accuracy	$T_C = +25^\circ\text{C}$ , $I_O = I_{O \text{ nom}}$ , $V_I = 53 \text{ V}$		11.94	12.10	12.26	11.94	12.10	12.26	V
	Output adjust range <sup>1)</sup>			10.80		13.20	10.80		13.20	V
$V_O$	Output voltage tolerance band	Long term drift included	$I_O = 0.1 \dots 1.0 \times I_{O \text{ nom}}$ $I_{O1} = I_{O2}$	11.70		12.50	11.70		12.60	V
	Idling voltage	$I_O = 0 \text{ A}$				12.65			20	V
	Line regulation	$I_O = I_{O \text{ nom}}$	$V_I = 38 \dots 60 \text{ V}$	10			10			mV
			$V_I = 50 \dots 72 \text{ V}$	10			10			
	Load regulation	$I_{O1} = 0.1 \dots 1.0 \times I_{O1 \text{ nom}}$ , $I_{O2} = I_{O2 \text{ nom}}$ , $V_I = 53 \text{ V}$		20						mV
$t_{\text{tr}}$	Load transient recovery time	$I_O = 0.1 \dots 1.0 \times I_{O \text{ nom}}$ , $V_I = 53 \text{ V}$ load step = $0.5 \times I_{O \text{ nom}}$ , $I_{O1} = I_{O2}$		100			100			$\mu\text{s}$
$V_{\text{tr}}$	Load transient voltage			+850			+850			mV
				-850			-850			mV
$T_{\text{coeff}}$	Temperature coefficient <sup>2)</sup>	$I_O = I_{O \text{ nom}}$ , $T_C < T_{C \text{ max}}$		see PKG 4623 PI Temperature characteristics						
$t_r$	Ramp-up time	$I_O = 0.1 \dots 1.0 \times I_{O \text{ max}}$	$0.1 \dots 0.9 \times V_O$	10			10			ms
$t_s$	Start-up time	$V_I = 53 \text{ V}$	From $V_I$ connection to $V_O = 0.9 \times V_{O1}$	30			30			ms
$I_O$	Output current			0		4.0	0		4.0	A
$P_{O \text{ max}}$	Max total output power <sup>3)</sup>	Calculated value		min 60						W
$I_{\text{lim}}$	Current limiting threshold	$T_C < T_{C \text{ max}}$		min $1.02 \times P_{O \text{ max}}$ <sup>4)</sup>						
$I_{\text{sc}}$	Short circuit current	$V_O = 0.2 \dots 0.5 \text{ V}$ , $T_A = 25^\circ\text{C}$ , $R_{\text{SC}} > 0.1 \Omega$		7			7			A
$V_{O \text{ ac}}$	Output ripple	$I_O = I_{O \text{ nom}}$	20 Hz ... 5 MHz	100	150		100	150		$\text{mV}_{\text{p-p}}$
SVR	Supply voltage rejection (ac)	$f = 100 \text{ Hz}$ sine wave, $1 V_{\text{p-p}}$ , $V_I = 53 \text{ V}$ (SVR = $20 \log(1 V_{\text{p-p}}/V_{O \text{ p-p}})$ )		43			43			dB
OVP	Over voltage protection	$I_O > 0.1 \times I_{O \text{ max}}$		14.5						V

<sup>1)</sup> See Operating information.

<sup>2)</sup> Temperature coefficient is positive at low temperatures and negative at high temperatures.

<sup>3)</sup> See also Typical Characteristics, Power derating.

<sup>4)</sup>  $I_{\text{lim}}$  on each output is set by the total load.

## Miscellaneous

Characteristics		Conditions	min	typ	max	Unit
$\eta$	Efficiency	$I_O = I_{O \text{ nom}}$ , $V_I = 53 \text{ V}$		89		%
$P_d$	Power dissipation	$I_O = I_{O \text{ nom}}$ , $V_I = 53 \text{ V}$		7.4		W

# PKG 4625 PI

$T_C = -30 \dots +90^\circ\text{C}$ ,  $V_I = 38 \dots 72\text{V}$  unless otherwise specified.  $I_{O1 \text{ nom}} = 2.0 \text{ A}$ ,  $I_{O2 \text{ nom}} = 2.0 \text{ A}$ .

## Output

Characteristics		Conditions		Output 1			Output 2			Unit
				min	typ	max	min	typ	max	
$V_{O_i}$	Output voltage initial setting and accuracy	$T_C = +25^\circ\text{C}$ , $I_O = I_{O \text{ nom}}$ , $V_I = 53 \text{ V}$		14.90	15.00	15.10	14.90	15.00	15.10	V
	Output adjust range <sup>1)</sup>			12.00	16.50		12.00	16.50		V
$V_O$	Output voltage tolerance band	Long term drift included	$I_O = 0.1 \dots 1.0 \times I_{O \text{ nom}}$ $I_{O1} = I_{O2}$	14.20	15.65		14.20	15.65		V
	Idling voltage	$I_O = 0 \text{ A}$		17			26		V	
	Line regulation	$I_O = I_{O \text{ nom}}$	$V_I = 38 \dots 60 \text{ V}$	15			15		mV	
			$V_I = 50 \dots 72 \text{ V}$	15			15			
	Load regulation	$I_{O1} = 0.1 \dots 1.0 \times I_{O1 \text{ nom}}$ , $I_{O2} = I_{O2 \text{ nom}}$ , $V_I = 53 \text{ V}$		50			50		mV	
$t_{tr}$	Load transient recovery time	$I_O = 0.1 \dots 1.0 \times I_{O \text{ nom}}$ , $V_I = 53 \text{ V}$ load step = $0.5 \times I_{O \text{ nom}}$ , $I_{O1} = I_{O2}$		150			150		$\mu\text{s}$	
$V_{tr}$	Load transient voltage			+750			+750		mV	
				-1300			-1300		mV	
$T_{\text{coeff}}$	Temperature coefficient <sup>2)</sup>	$I_O = I_{O \text{ nom}}$ , $T_C < T_{C \text{ max}}$		see PKG 4625 PI Temperature characteristics						
$t_r$	Ramp-up time	$I_O = 0.1 \dots 1.0 \times I_{O \text{ max}}$ $V_I = 53 \text{ V}$	$0.1 \dots 0.9 \times V_O$	10			10		ms	
$t_s$	Start-up time		From $V_I$ connection to $V_O = 0.9 \times V_{O_i}$	15			15		ms	
$I_O$	Output current			0	3.2		0	3.2		A
$P_{O \text{ max}}$	Max total output power <sup>3)</sup>	Calculated value		min 60						W
$I_{\text{lim}}$	Current limiting threshold	$T_C < T_{C \text{ max}}$		min $1.02 \times P_{O \text{ max}}$ <sup>4)</sup>						
$I_{\text{sc}}$	Short circuit current	$V_O = 0.2 \dots 0.5\text{V}$ , $T_A = 25^\circ\text{C}$ , $R_{\text{SC}} > 0.1\Omega$		9			9		A	
$V_{O \text{ ac}}$	Output ripple	$I_O = I_{O \text{ nom}}$	20 Hz... 5 MHz	100	150		100	150		mV <sub>p-p</sub>
SVR	Supply voltage rejection (ac)	$f = 100 \text{ Hz}$ sine wave, $1 V_{p-p}$ , $V_I = 53 \text{ V}$ (SVR = $20 \log(1 V_{p-p}/V_{O \text{ p-p}})$ )		43			43		dB	
OVP	Over voltage protection	$I_O > 0.1 \times I_{O \text{ max}}$		18					V	

1) See Operating information.

2) Temperature coefficient is positive at low temperatures and negative at high temperatures.

3) See also Typical Characteristics, Power derating.

4)  $I_{\text{lim}}$  on each output is set by the total load.

## Miscellaneous

Characteristics		Conditions		min	typ	max	Unit
$\eta$	Efficiency	$I_O = I_{O \text{ nom}}$ , $V_I = 53 \text{ V}$		89			%
$P_d$	Power dissipation	$I_O = I_{O \text{ nom}}$ , $V_I = 53 \text{ V}$		7.4			W

# PKG 4627 PI

$T_C = -30 \dots +90^\circ\text{C}$ ,  $V_I = 38 \dots 72\text{V}$  unless otherwise specified.  $I_{O1 \text{ nom}} = 6.0 \text{ A}$ ,  $I_{O2 \text{ nom}} = 2.5 \text{ A}$ .

## Output

Characteristics		Conditions		Output 1			Output 2			Unit
				min	typ	max	min	typ	max	
$V_{O_i}$	Output voltage initial setting and accuracy	$T_C = +25^\circ\text{C}$ , $I_O = I_{O \text{ nom}}$ , $V_I = 53 \text{ V}$		5.11	5.15	5.19	11.92	12.10	12.28	V
	Output adjust range <sup>1)</sup>			4.63		5.67	10.80		13.20	V
$V_O$	Output voltage tolerance band	Long term drift included	$I_O = 0.1 \dots 1.0 \times I_{O \text{ nom}}$ $I_{O1} = 2.4 \times I_{O2}$	5.00		5.25	11.70		12.60	V
	Idling voltage	$I_O = 0 \text{ A}$				5.45			20	V
	Line regulation	$I_O = I_{O \text{ nom}}$	$V_I = 38 \dots 60 \text{ V}$	12			25			mV
			$V_I = 50 \dots 72 \text{ V}$	4			8			
	Load regulation	$I_{O1} = 0.1 \dots 1.0 \times I_{O1 \text{ nom}}$ , $I_{O2} = I_{O2 \text{ nom}}$ , $V_I = 53 \text{ V}$		10						mV
$t_{tr}$	Load transient recovery time	$I_O = 0.1 \dots 1.0 \times I_{O \text{ nom}}$ , $V_I = 53 \text{ V}$ load step = $0.5 \times I_{O \text{ nom}}$		100			100			$\mu\text{s}$
$V_{tr}$	Load transient voltage			+350			+850			mV
				-400			-850			mV
$T_{\text{coeff}}$	Temperature coefficient <sup>2)</sup>	$I_O = I_{O \text{ nom}}$ , $T_C < T_{C \text{ max}}$		see PKG 4627 PI Temperature characteristics						
$t_r$	Ramp-up time	$I_O = 0.1 \dots 1.0 \times I_{O \text{ max}}$ $V_I = 53 \text{ V}$	$0.1 \dots 0.9 \times V_O$	10			10			ms
$t_s$	Start-up time		From $V_I$ connection to $V_O = 0.9 \times V_{O_i}$	30			30			ms
$I_O$	Output current			0	9.0		0	3.0		A
$P_{O \text{ max}}$	Max total output power <sup>3)</sup>	Calculated value		min 60						W
$I_{\text{lim}}$	Current limiting threshold	$T_C < T_{C \text{ max}}$		min $1.02 \times P_{O \text{ max}}^4)$						
$I_{\text{sc}}$	Short circuit current	$V_O = 0.2 \dots 0.5 \text{ V}$ , $T_A = 25^\circ\text{C}$ , $R_{\text{SC}} > 0.1 \Omega$		17			7			A
$V_{O \text{ ac}}$	Output ripple	$I_O = I_{O \text{ nom}}$	20 Hz ... 5 MHz	100	150		100	150		mV <sub>p-p</sub>
SVR	Supply voltage rejection (ac)	$f = 100 \text{ Hz}$ sine wave, $1 \text{ V}_{p-p}$ , $V_I = 53 \text{ V}$ (SVR = $20 \log(1 \text{ V}_{p-p}/V_{O \text{ p-p}})$ )		43			35			dB
OVP	Over voltage protection	$I_O > 0.1 \times I_{O \text{ max}}$		6						V

1) See Operating information.

2) Temperature coefficient is positive at low temperatures and negative at high temperatures.

3) See also Typical Characteristics, Power derating.

4)  $I_{\text{lim}}$  on each output is set by the total load.

## Miscellaneous

Characteristics		Conditions	min	typ	max	Unit
$\eta$	Efficiency	$I_O = I_{O \text{ nom}}$ , $V_I = 53 \text{ V}$		88		%
$P_d$	Power dissipation	$I_O = I_{O \text{ nom}}$ , $V_I = 53 \text{ V}$		8		W

# Typical Characteristics

## PKG 4310 PI

Efficiency (typ)

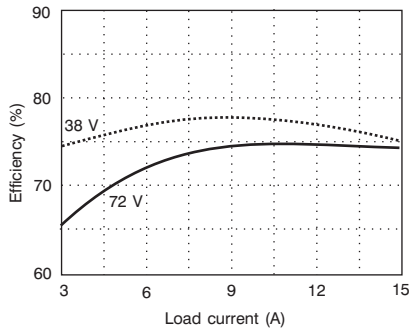

Output characteristic (typ)

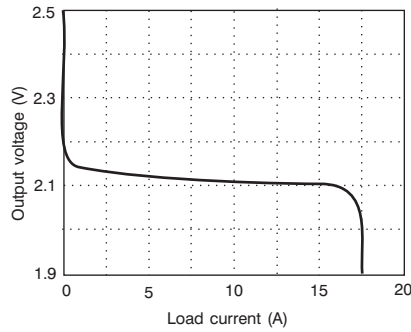

Power derating

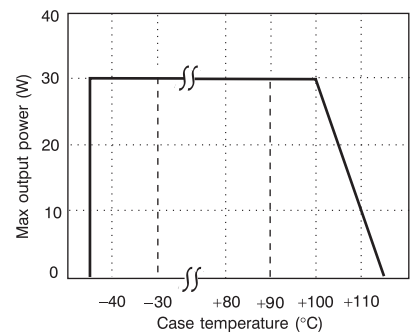

Temperature characteristics

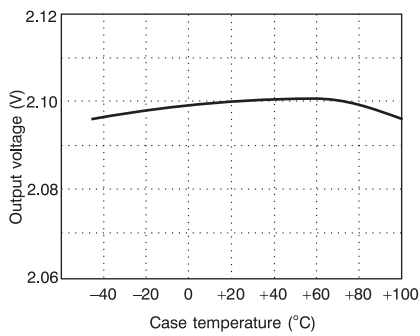

Dynamic load response (typ)

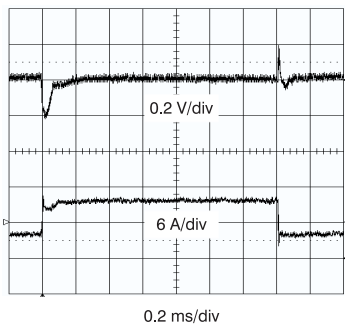

1. Maximum deviation  $\Delta V_O < 0.1 \times V_{O1}$   
Recover time  $t_r < 100 \mu s$   
The output voltage deviation is determined by the load transient ( $di/dt$ )

2. Load change:  
 $0.25 \times I_{O\text{nom}} \dots 0.75 \times I_{O\text{nom}} \dots 0.25 \times I_{O\text{nom}}$   
 $di/dt \approx 5 \text{ A}/\mu s$

## PKG 4319 PI

Efficiency (typ)

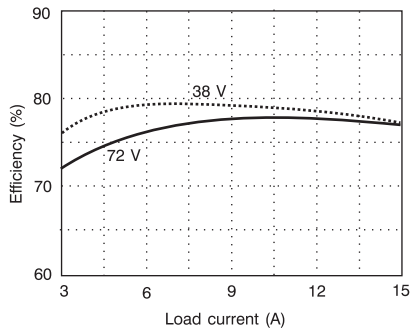

Output characteristic (typ)

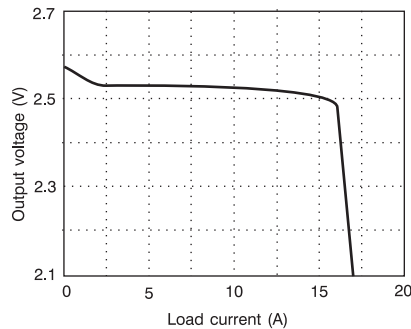

Power derating

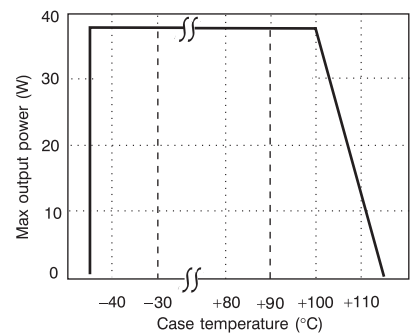

Temperature characteristics

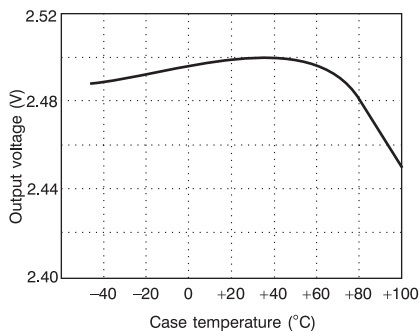

Dynamic load response (typ)

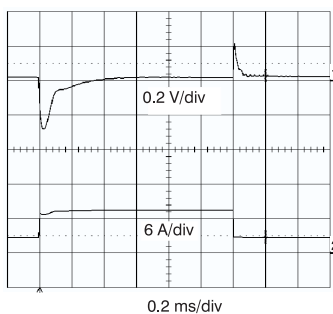

1. Maximum deviation  $\Delta V_O < 0.1 \times V_{O1}$   
Recover time  $t_r < 100 \mu s$   
The output voltage deviation is determined by the load transient ( $di/dt$ )

2. Load change:  
 $0.25 \times I_{O\text{nom}} \dots 0.75 \times I_{O\text{nom}} \dots 0.25 \times I_{O\text{nom}}$   
 $di/dt \approx 5 \text{ A}/\mu s$

## PKG 4410 PI

**Efficiency (typ)**

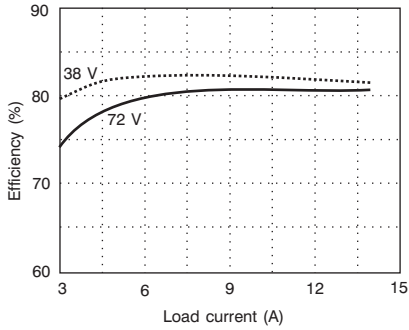

**Output characteristic (typ)**

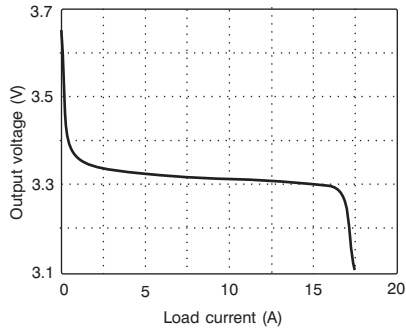

**Power derating**

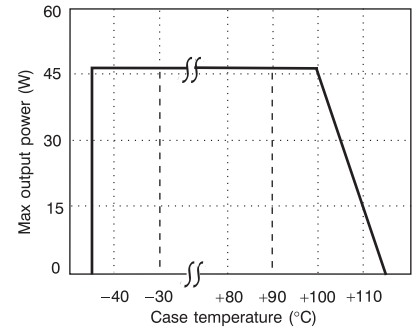

**Temperature characteristics**

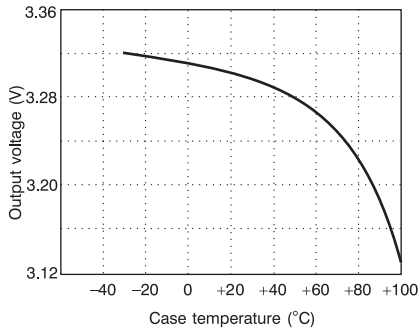

**Dynamic load response (typ)**

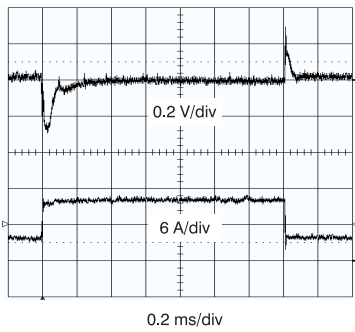

1. Maximum deviation  $\Delta V_O < 0.1 \times V_{O_i}$   
Recover time  $t_r < 100 \mu s$   
The output voltage deviation is determined by the load transient (di/dt)

2. Load change:  
 $0.25 \times I_{O_{nom}} \dots 0.75 \times I_{O_{nom}} \dots 0.25 \times I_{O_{nom}}$   
 $di/dt \approx 5 A/\mu s$

## PKG 4611 PI

**Efficiency (typ)**

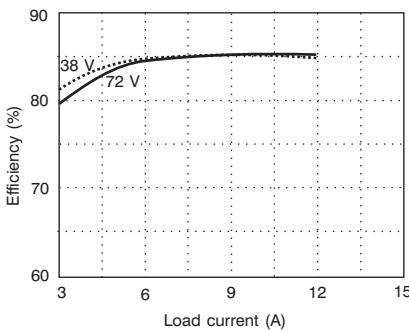

**Output characteristic (typ)**

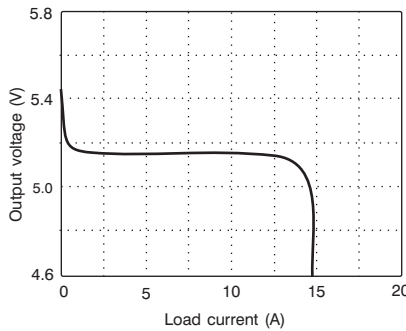

**Power derating**

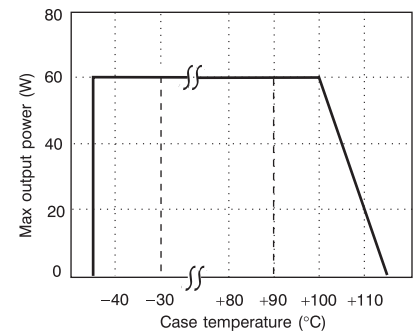

**Temperature characteristics**

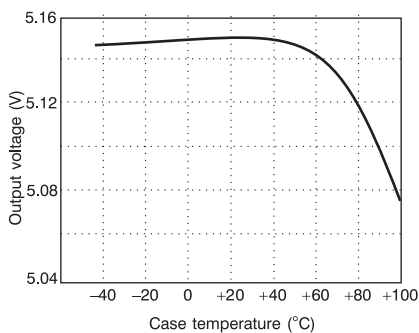

**Dynamic load response (typ)**

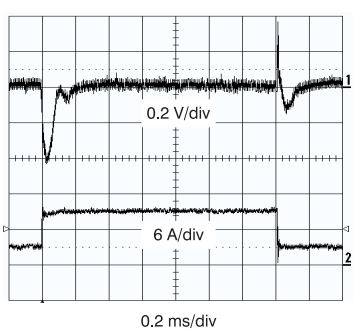

1. Maximum deviation  $\Delta V_O < 0.1 \times V_{O_i}$   
Recover time  $t_r < 100 \mu s$   
The output voltage deviation is determined by the load transient (di/dt)

2. Load change:  
 $0.25 \times I_{O_{nom}} \dots 0.75 \times I_{O_{nom}} \dots 0.25 \times I_{O_{nom}}$   
 $di/dt \approx 5 A/\mu s$

## PKG 4617 PIOA

Efficiency (typ)

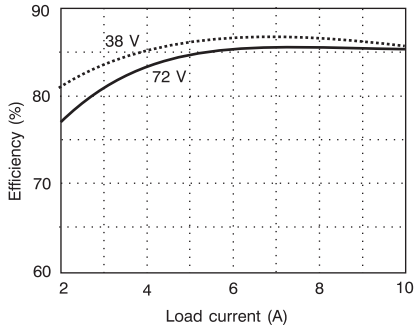

Output characteristic (typ)

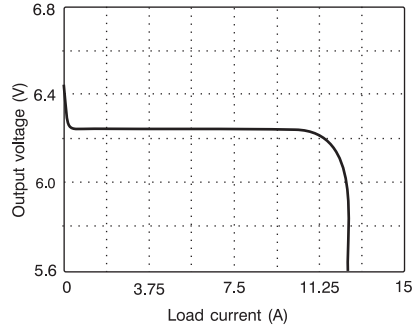

Power derating

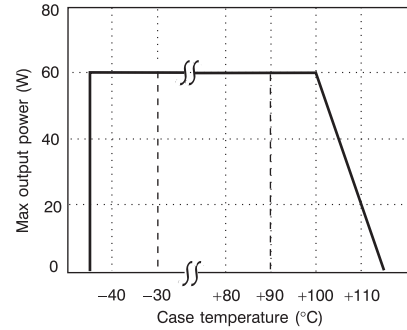

Temperature characteristics

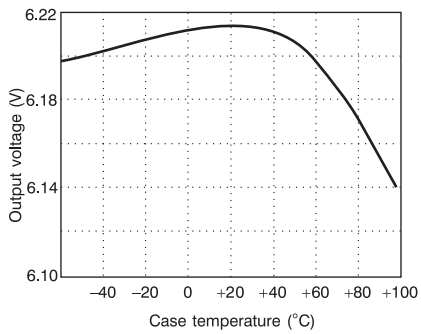

Dynamic load response (typ)

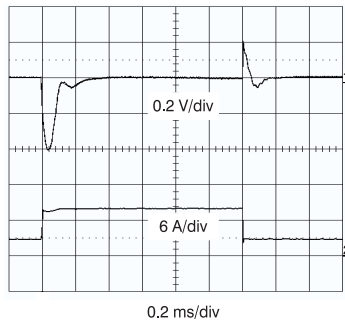

1. Maximum deviation  $\Delta V_O < 0.1 \times V_{O1}$   
Recover time  $t_r < 100 \mu s$   
The output voltage deviation is determined by the load transient (dl/dt)
2. Load change:  
 $0.25 \times I_{O nom} \dots 0.75 \times I_{O nom} \dots 0.25 \times I_{O nom}$   
 $dl/dt \approx 5 A/\mu s$

## PKG 4428 PI

Efficiency (typ)

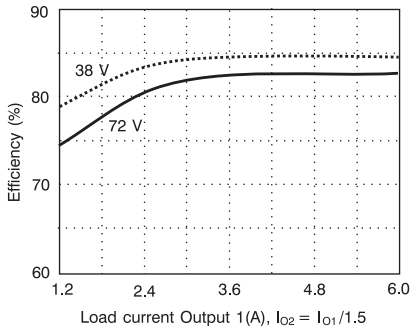

Output characteristic (typ)

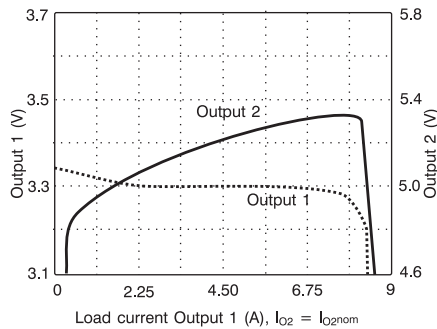

Power derating

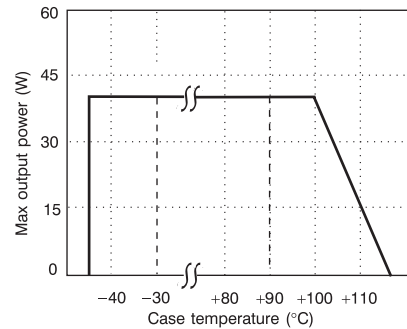

Temperature characteristics

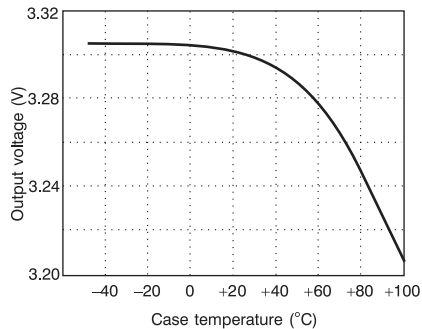

Dynamic load response (typ)

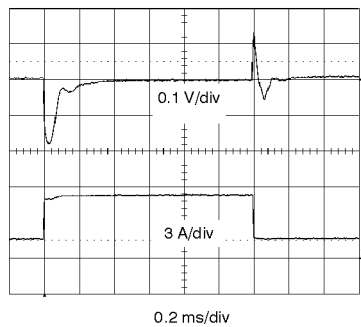

1. Maximum deviation  $\Delta V_O < 0.1 \times V_{O1}$   
Recover time  $t_r < 100 \mu s$   
The output voltage deviation is determined by the load transient (dl/dt)
2. Load change:  
 $0.25 \times I_{O nom} \dots 0.75 \times I_{O nom} \dots 0.25 \times I_{O nom}$   
 $dl/dt \approx 5 A/\mu s$



## PKG 4623 PI

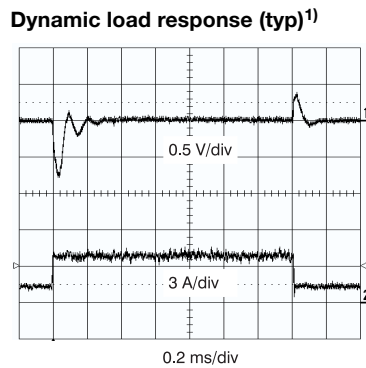
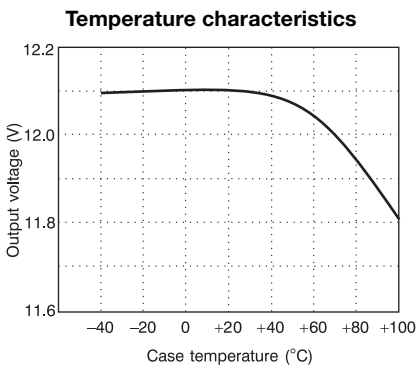
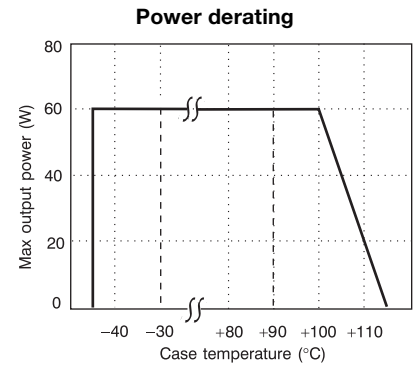
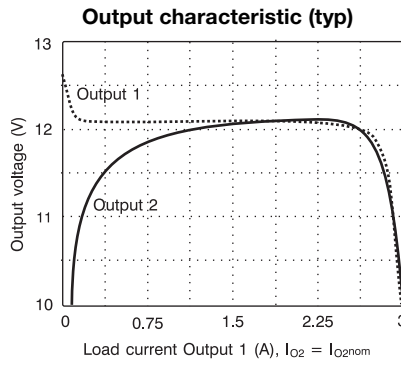
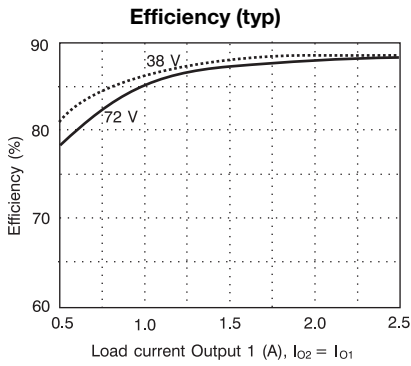

1. Maximum deviation  $\Delta V_O < 0.1 \times V_{O_i}$   
Recover time  $t_r < 100 \mu s$   
The output voltage deviation is determined by the load transient (dl/dt)
  2. Load change:  
 $0.25 \times I_{O nom} \dots 0.75 \times I_{O nom} \dots 0.25 \times I_{O nom}$   
 $dl/dt \approx 5 A/\mu s$
- <sup>1)</sup> Outputs paralleled.

## PKG 4625 PI

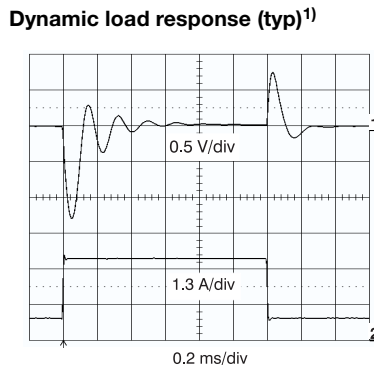
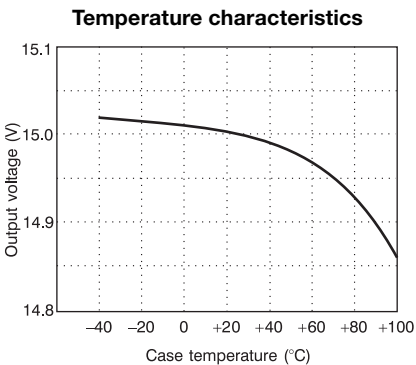
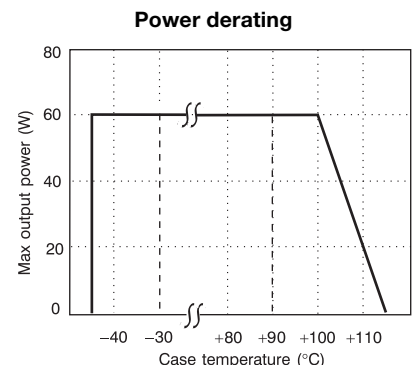
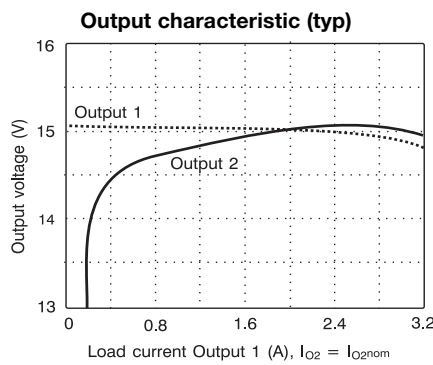
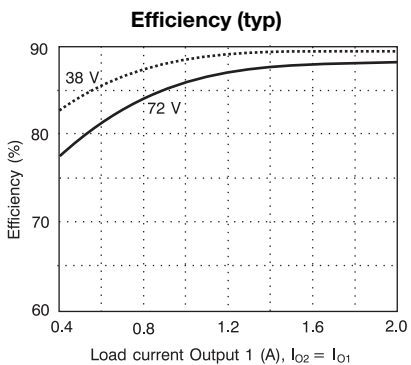

1. Maximum deviation  $\Delta V_O < 0.1 \times V_{O_i}$   
The output voltage deviation is determined by the load transient (dl/dt)
  2. Load change:  
 $0.25 \times I_{O nom} \dots 0.75 \times I_{O nom} \dots 0.25 \times I_{O nom}$   
 $dl/dt \approx 5 A/\mu s$
- <sup>1)</sup> Outputs paralleled.

# PKG 4627 PI

**Efficiency (typ)**

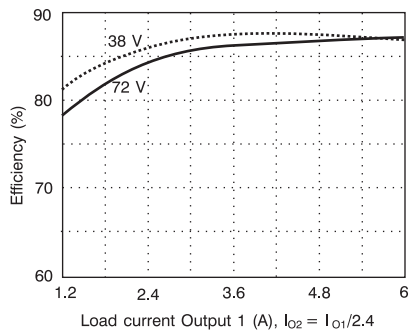

**Output characteristic (typ)**

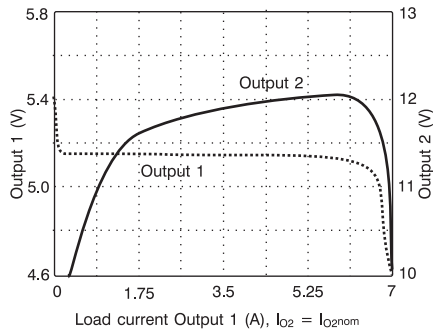

**Power derating**

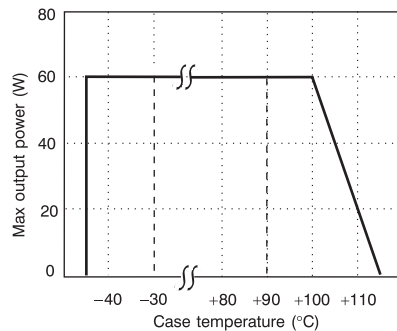

**Temperature characteristics**

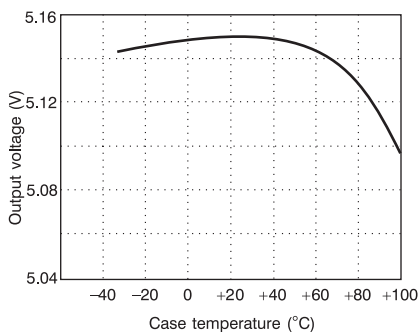

**Dynamic load response (typ)**

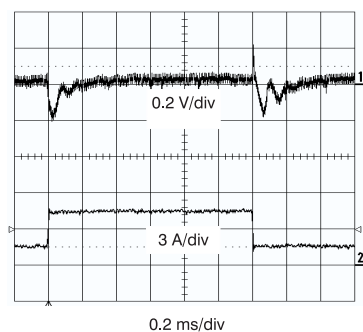

1. Maximum deviation  $\Delta V_O < 0.1 \times V_{O_i}$   
 Recover time  $t_r < 100 \mu s$   
 The output voltage deviation is determined by the load transient (di/dt)
2. Load change:  
 $0.25 \times I_{O_{nom}} \dots 0.75 \times I_{O_{nom}} \dots 0.25 \times I_{O_{nom}}$   
 $di/dt \approx 5 A/\mu s$

# EMC Specifications

The PKG power module is mounted on a double sided printed circuit board (PB) with ground-plane during EMC measurements.

The fundamental switching frequency is  $510 \text{ kHz} \pm 5\%$  @  $V_I = 53 \text{ V}$ ,  $I_O = (0.1 \dots 1.0) \times I_{O \text{ max}}$ .

## Conducted EMI Input terminal value (typ)

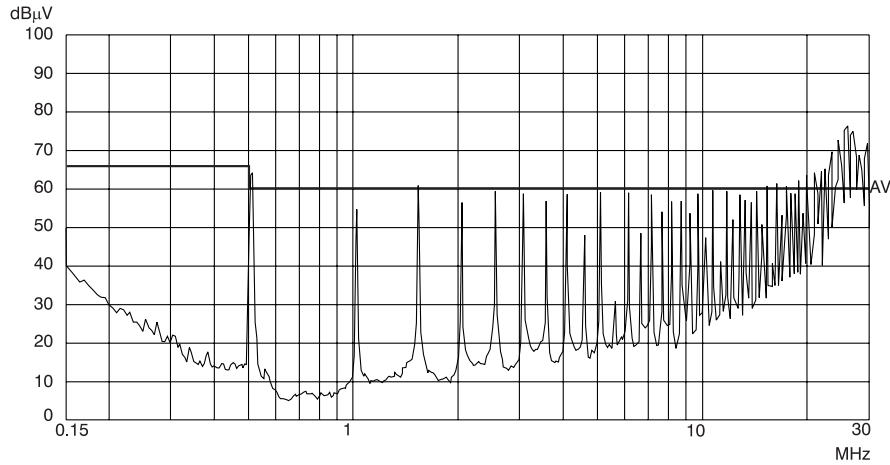

## External Filter (class B)

Required external input filter in order to meet class B in EN 55022, CISPR 22 and FCC part 15J.

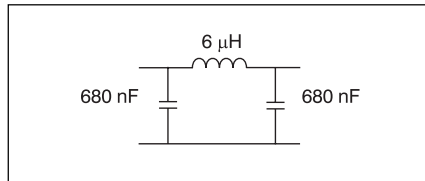

The capacitors are of ceramic type. The low ESR is critical for the result.

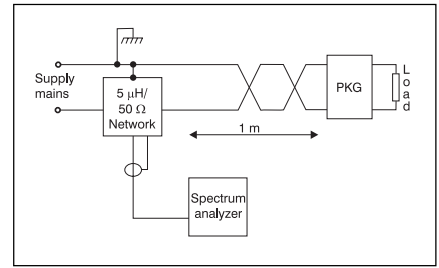
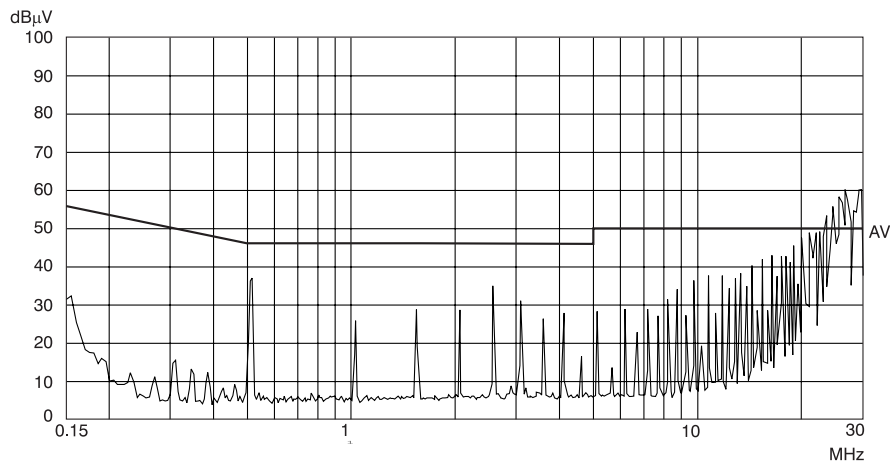

Test Set-up according to CISPR publ. 1A.

## Radiated EMS (Electro-Magnetic Fields)

Radiated EMS is measured according to test methods in IEC Standard publ. 801-3. No deviation outside the  $V_O$  tolerance band will occur under the following conditions:

Frequency range	Voltage level
0.01...200 MHz	3 $V_{\text{rms/m}}$
200...1,000 MHz	3 $V_{\text{rms/m}}$
1...12 GHz	10 $V_{\text{rms/m}}$

## EFT

Electrical Fast Transients on the input terminals may cause output deviations outside what is tolerated by the electronic circuits, i.e.  $\pm 5\%$ .

The PKG power module can withstand EFT levels of 0.5 kV keeping  $V_O$  within the tolerance band and 2.0 kV without destruction. Tested according to IEC publ. 801-4.

## Output Ripple & Noise ( $V_{Oac}$ )

Output ripple is measured as the peak to peak voltage of the fundamental switching frequency.

## Operating information

### Remote Control (RC)

Remote turn-on and turn-off can be realized by using the RC-pin. Normal operation is achieved if pin 1 is open (NC). If pin 1 is connected to pin 4 the PKG power module turns off. To ensure safe turn-off the voltage difference between pin 1 and 4 shall be less than 1.0 V. RC is TTL open collector compatible (see fig. 1).

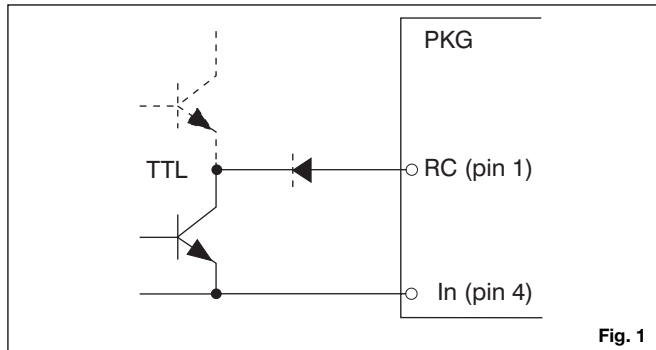

Fig. 1

### Over Voltage Protection (OVP)

The PKG series has an internal Over Voltage Protection circuitry. The circuitry will detect over voltage conditions on the output and stop the power module operation. During OVP conditions there are continuous attempts to start up (non-latching mode). If latching mode is preferred an external circuit can be used to change the function and make the output remain in off mode after over voltage detection. (The OVP level can be found in the output data section.)

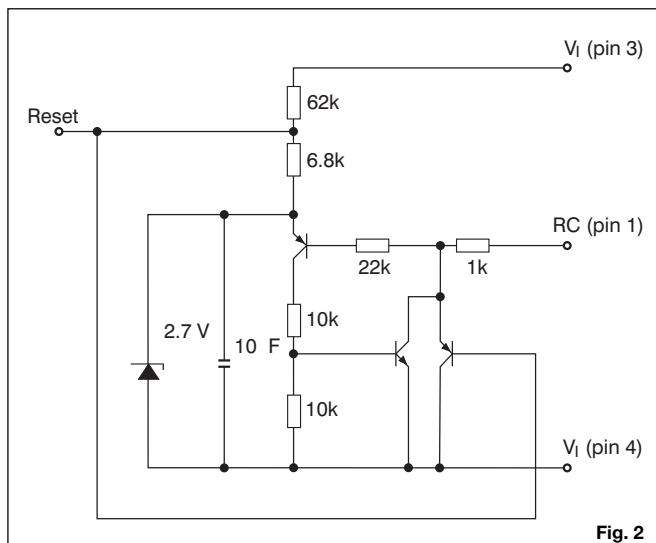

Fig. 2

### Turn-off Input Voltage (TOA)

The power module monitors the input voltage and will turn on and turn off at predetermined levels. The levels can be decreased by means of an external resistor connected between pin 2 and pin 3. A 0.5 MΩ resistor will decrease the turn-off input voltage approximately 10%.

### Output Voltage Adjust (V<sub>adj</sub>)

To decrease the output voltage the resistor should be connected between pin 10 and pin 9 (+ Out 1). To increase the output voltage the resistor should be connected between pin 10 and pin 8 (- Out1). Output voltage, V<sub>O</sub>, can be adjusted by using an external resistor. A 0.1 MΩ resistor will change V<sub>O</sub> approximately 5%.

### Maximum Capacitive Load

The PKG series has no limitation of maximum connected capacitance on the output, however the power module may operate in current limiting mode during start-up, affecting the ramp-up and the start-up time if large capacitance values are connected. For optimum performance we recommend a maximum of 100 μF/A of I<sub>O</sub> for dual outputs. Connect capacitors at the point of load for best performance.

### Parallel Operation

The load regulation characteristics and temperature coefficients of the PKG DC/DC Power Modules are designed to allow parallel operation. Paralleling of several modules is easily accomplished by connection of the output voltage terminal pins. The connections should be symmetrical, i.e. the resistance between the output terminal and the common connection point of each module should be equal. Good paralleling performance is achieved if you allow the resistance to be 10 mΩ. 10 mΩ equals 50 mm (2 in) of 35 μm (1 oz/ft<sup>2</sup>) copper with a trace width of 2.5 mm (0.1 in).

It is recommended not to exceed  $P_O = n \times 0.8 \times P_{O,max}$ , where P<sub>O,max</sub> is the maximum converter output power and n the number of paralleled converters, in order to avoid overloading any of the converters and thereby decreasing the reliability.

Paralleling performance may be further improved by voltage matching. Voltage matching is accomplished by using the Output Adjust function and trim the outputs to the same voltage.

### Current Limiting Protection

The output power is limited at loads above the output current limiting threshold (I<sub>lim</sub>), specified as a minimum value.

### Input and Output Impedance

Both the source impedance of the power feeding and the load impedance will interact with the impedance of the DC/DC power module. It is most important to have the ratio between L and C as low as possible, i.e. a low characteristic impedance, both at the input and output, as the power modules have a low energy storage capability. Use an electrolytic capacitor across the input or output if the source or load inductance is larger than 10 μH. Their equivalent series resistance together with the capacitance acts as a lossless damping filter. Suitable capacitor values are in the range 10–100 μF.

# Quality

## Reliability

Meantime between failure (MTBF) is calculated to >1.7 million hours at full output power and a case temperature of +75°C ( $T_A = +40$  °C), using the Ericsson failure rate data system. The Ericsson failure rate data system is based on field failure rates and is continuously updated. The data corresponds to actual failure rates of component used in Information Technology and Telecom equipment in temperature contled environments ( $T_A = -5 \dots +65$  °C). The data is considered to have a confidence level of 90%. For more information see Design Note 002.

## Quality Statement

The products are designed and manufactured in an industrial environment where quality systems and methods like ISO 9000, 6 $\sigma$  and SPC, are intensively in use to boost the continuous improvements strategy. Infant mortality or early failures in the products are screened out by a burn-in procedure and an ATE-based final test. Conservative design rules, design reviews and product qualifications, as well as high competence of an engaged work force, contribute to the high quality of our products.

## Warranty

Ericsson Microelectronics warrants to the original purchaser or end user that the products conform to this Data Sheet and are free from material and workmanship defects for a period of five (5) years from the date of manufacture, if the product is used within specified conditions and not opened. In case the product is discontinued, claims will be accepted up to three (3) years from the date of the discontinuation. For additional details on this limited warranty we refer to Ericsson Microelectronics AB's "General Terms and Conditions of Sales", or individual contract documents.

## Limitation of Liability

Ericsson Microelectronics does not make any other warranties, expressed or implied including any warranty of merchantability or fitness for a particular purpose (including, but not limited to, use in life support applications, where malfunctions of product can cause injury to a person's health or life).

Information given in this data sheet is believed to be accurate and reliable. No responsibility is assumed for the consequences of its use nor for any infringement of patents or other rights of third parties which may result from its use. No license is granted by implication or otherwise under any patent or patent rights of Ericsson Microelectronics. These products are sold only according to Ericsson Microelectronics' general conditions of sale, unless otherwise confirmed in writing. Specifications subject to change without notice.





## Product Program

V <sub>i</sub>	V <sub>o</sub> /I <sub>o</sub> max		P <sub>o</sub> max	Ordering No.
	Output 1	Output 2		
48/60 V	2.1 V/14.5 A		30 W	PKG 4310 PI
	2.5 V/15 A		38 W	PKG 4319 PI
	3.3 V/14 A		46 W	PKG 4410 PI
	5 V/12 A		60 W	PKG 4611 PI
	6.2 V/10 A		60 W	PKG 4617 PIOA
	3.3 V/9.6 A	5 V/6.4 A	40 W	PKG 4428 PI
	12 V/4 A	12 V/4 A	60 W	PKG 4623 PI
	15 V/3.2 A	15 V/3.2 A	60 W	PKG 4625 PI
	5 V/9 A	12 V/3 A	60 W	PKG 4627 PI

Ericsson Microelectronics  
 SE-164 81 KISTA, Sweden  
 Phone: +46 8 757 5000  
[www.ericsson.com/microelectronics](http://www.ericsson.com/microelectronics)

For local sales contacts, please refer to our website  
 or call: Int. +46 8 757 4700, Fax: +46 8 757 4776

The latest and most complete information can be found on our website!

Data Sheet

EN/LZT 146 04 R1B

© Ericsson Microelectronics AB, November 2001