

74AC86

Quad 2-Input Exclusive-OR Gate

General Description

The AC86 contains four, 2-input exclusive-OR gates.

Features

- I_{CC} reduced by 50%
- Outputs source/sink 24 mA

Ordering Code:

Order Number	Package Number	Package Description
74AC86SC	M14A	14-Lead Small Outline Integrated Circuit (SOIC), JEDEC MS-120, 0.150" Narrow Body
74AC86SJ	M14D	14-Lead Small Outline Package (SOP), EIAJ TYPE II, 5.3mm Wide
74AC86MTC	MTC14	14-Lead Thin Shrink Small Outline Package (TSSOP), JEDEC MO-153, 4.4mm Wide
74AC86PC	N14A	14-Lead Plastic Dual-In-Line Package (PDIP), JEDEC MS-001, 0.300" Wide

Device also available in Tape and Reel. Specify by appending suffix letter "X" to the ordering code.

Connection Diagram

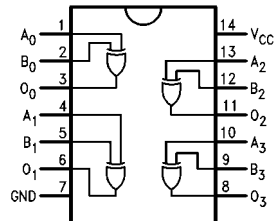

Logic Symbol

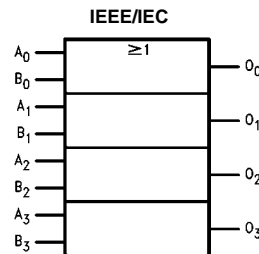

Pin Descriptions

Pin Names	Description
A ₀ -A ₃	Inputs
B ₀ -B ₃	Inputs
O ₀ -O ₃	Outputs

Absolute Maximum Ratings(Note 1)

Supply Voltage (V_{CC})	-0.5V to +7.0V
DC Input Diode Current (I_{IK})	
$V_I = 0.5V$	-20 mA
$V_I = V_{CC} + 0.5V$	+20 mA
DC Input Voltage (V_I)	-0.5V to $V_{CC} + 0.5V$
DC Output Diode Current (I_{OK})	
$V_O = -0.5V$	-20 mA
$V_O = V_{CC} + 0.5V$	+20 mA
DC Output Voltage (V_O)	-0.5V to $V_{CC} + 0.5V$
DC Output Source or Sink Current (I_O)	± 50 mA
DC V_{CC} or Ground Current	
Per Output Pin (I_{CC} or I_{GND})	± 50 mA
Storage Temperature (T_{STG})	-65°C to +150°C
Junction Temperature (T_J)	
PDIP	140°C

Recommended Operating Conditions

Supply Voltage (V_{CC})	2.0V to 6.0V
Input Voltage (V_I)	0V to V_{CC}
Output Voltage (V_O)	0V to V_{CC}
Operating Temperature (T_A)	-40°C to +85°C
Minimum Input Edge Rate ($\Delta V/\Delta t$)	125 mV/ns
V_{IN} from 30% to 70% of V_{CC}	
V_{CC} @ 3.3V, 4.5V, 5.5V	

Note 1: Absolute maximum ratings are those values beyond which damage to the device may occur. The databook specifications should be met, without exception, to ensure that the system design is reliable over its power supply, temperature, and output/input loading variables. Fairchild does not recommend operation of FACT™ circuits outside databook specifications.

DC Electrical Characteristics

Symbol	Parameter	V_{CC} (V)	$T_A = 25^\circ C$		$T_A = -40^\circ C$ to $+85^\circ C$		Units	Conditions
			Typ	Guaranteed Limits				
V_{IH}	Minimum HIGH Level Input Voltage	3.0	1.5	2.1	2.1	V	$V_{OUT} = 0.1V$ or $V_{CC} - 0.1V$	
		4.5	2.25	3.15	3.15			
		5.5	2.75	3.85	3.85			
V_{IL}	Maximum LOW Level Input Voltage	3.0	1.5	0.9	0.9	V	$V_{OUT} = 0.1V$ or $V_{CC} - 0.1V$	
		4.5	2.25	1.35	1.35			
		5.5	2.75	1.65	1.65			
V_{OH}	Minimum HIGH Level Output Voltage	3.0	2.99	2.9	2.9	V	$I_{OUT} = -50 \mu A$	
		4.5	4.49	4.4	4.4			
		5.5	5.49	5.4	5.4			
			3.0		2.56	2.46	V	$V_{IN} = V_{IL}$ or V_{IH} $I_{OH} = -12$ mA $I_{OH} = -24$ mA $I_{OH} = -24$ mA (Note 2)
			4.5		3.86	3.76		
			5.5		4.86	4.76		
V_{OL}	Maximum LOW Level Output Voltage	3.0	0.002	0.1	0.1	V	$I_{OUT} = 50 \mu A$	
		4.5	0.001	0.1	0.1			
		5.5	0.001	0.1	0.1			
			3.0		0.36	0.44	V	$V_{IN} = V_{IL}$ or V_{IH} $I_{OL} = 12$ mA $I_{OL} = 24$ mA $I_{OL} = 24$ mA (Note 2)
			4.5		0.36	0.44		
			5.5		0.36	0.44		
I_{IN} (Note 4)	Maximum Input Leakage Current	5.5		± 0.1	± 1.0	μA	$V_I = V_{CC}, GND$	
I_{OLD}	Minimum Dynamic	5.5			75	mA	$V_{OLD} = 1.65V$ Max	
I_{OHD}	Output Current (Note 3)	5.5			-75	mA	$V_{OHD} = 3.85V$ Min	
I_{CC} (Note 4)	Maximum Quiescent Supply Current	5.5		2.0	20.0	μA	$V_{IN} = V_{CC}$ or GND	

Note 2: All outputs loaded; thresholds on input associated with output under test.

Note 3: Maximum test duration 20 ms, one output loaded at a time.

Note 4: I_{IN} and I_{CC} @ 3.0V are guaranteed to be less than or equal to the respective limit @ 5.5V V_{CC} .

AC Electrical Characteristics

Symbol	Parameter	V _{CC} (V) (Note 5)	T _A = +25°C C _L = 50 pF			T _A = -40°C to +85°C C _L 40 pF		Units
			Min	Typ	Max	Min	Max	
t _{PHL}	Propagation Delay	3.3	2.0	6.0	11.5	1.5	12.5	ns
	Inputs to Outputs	5.0	1.5	4.5	8.5	1.0	9.5	
t _{PLH}	Propagation Delay	3.3	2.0	6.5	11.5	1.5	12.5	ns
	Inputs to Outputs	5.0	1.5	4.5	8.5	1.0	9.0	

Note 5: Voltage Range 3.3V is 3.3V ± 0.3V
Voltage Range 5.0V is 5.0V ± 0.5V

Capacitance

Symbol	Parameter	Typ	Units	Conditions
C _{IN}	Input Capacitance	4.5	pF	V _{CC} = OPEN
C _{PD}	Power Dissipation Capacitance	35	pF	V _{CC} = 5.0V

Physical Dimensions inches (millimeters) unless otherwise noted

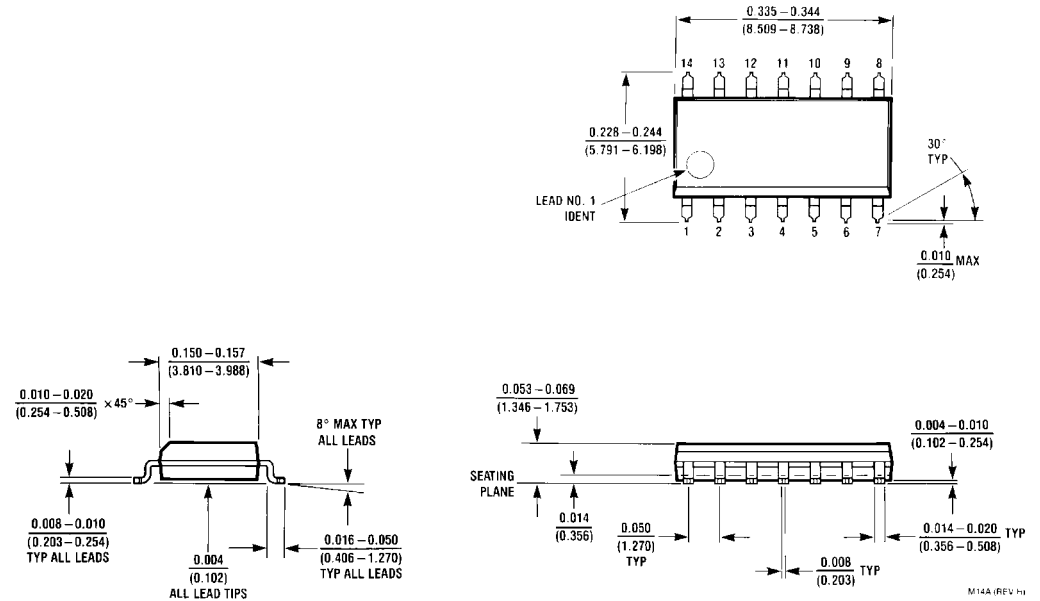

**14-Lead Small Outline Integrated Circuit (SOIC), JEDEC MS-120, 0.150" Narrow Body
Package Number M14A**

Physical Dimensions inches (millimeters) unless otherwise noted (Continued)

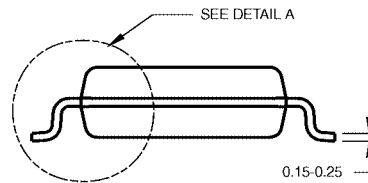
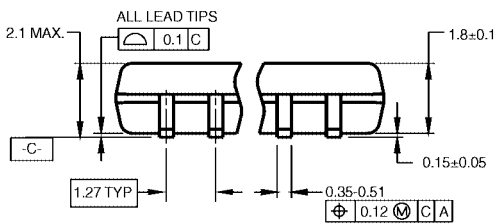
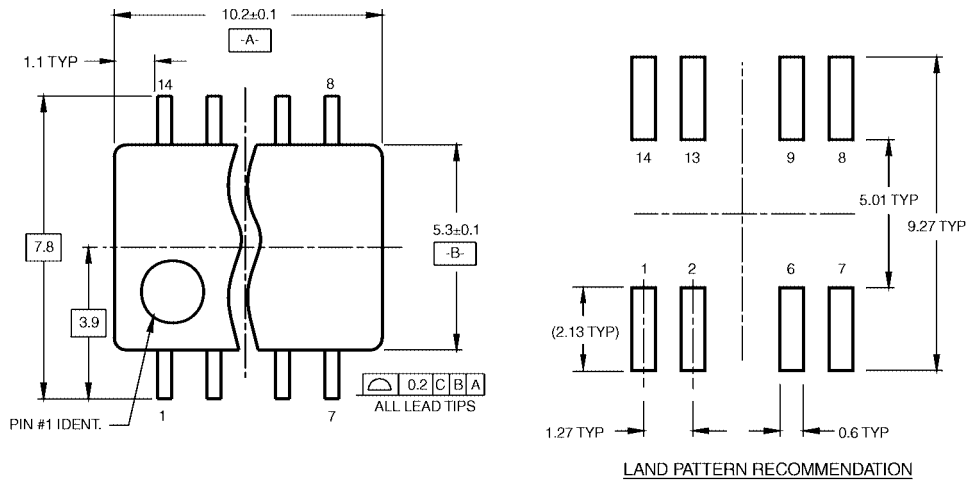

DIMENSIONS ARE IN MILLIMETERS

- NOTES:
 A. CONFORMS TO EIAJ EDR-7320 REGISTRATION, ESTABLISHED IN DECEMBER, 1998.
 B. DIMENSIONS ARE IN MILLIMETERS.
 C. DIMENSIONS ARE EXCLUSIVE OF BURRS, MOLD FLASH, AND TIE BAR EXTRUSIONS.

M14DRevB1

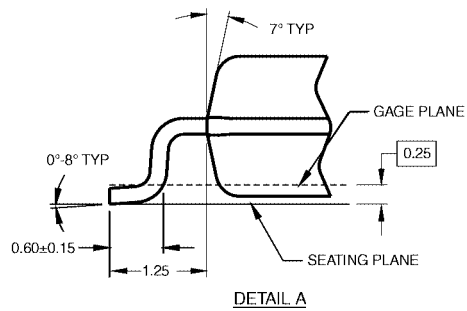

**14-Lead Small Outline Package (SOP), EIAJ TYPE II, 5.3mm Wide
 Package Number M14D**

Physical Dimensions inches (millimeters) unless otherwise noted (Continued)

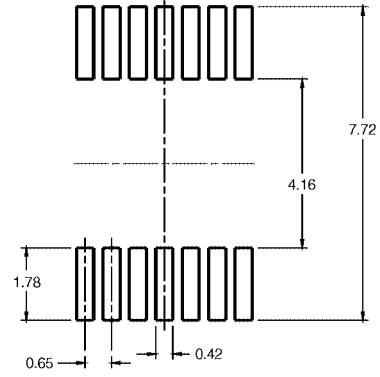
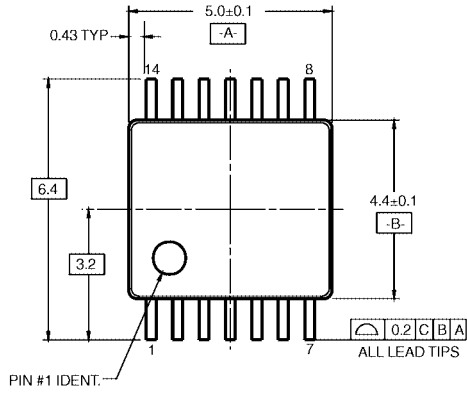

LAND PATTERN RECOMMENDATION

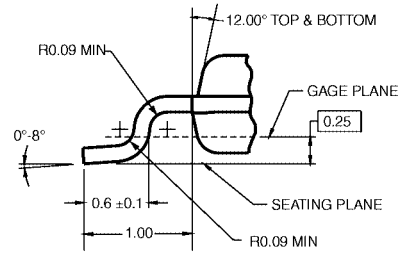
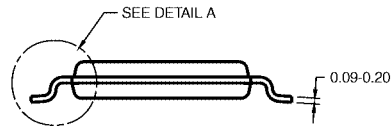
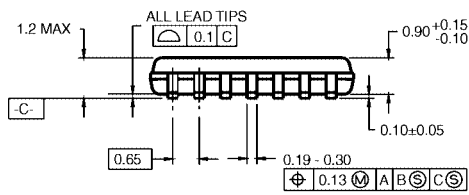

DETAIL A

- NOTES:
 A. CONFORMS TO JEDEC REGISTRATION MO-153, VARIATION AB, REF NOTE 6, DATE 7/93.
 B. DIMENSIONS ARE IN MILLIMETERS.
 C. DIMENSIONS ARE EXCLUSIVE OF BURRS, MOLD FLASH, AND TIE BAR EXTRUSIONS.
 D. DIMENSIONS AND TOLERANCES PER ANSI Y14.5M, 1982.

MTC14RevC3

14-Lead Thin Shrink Small Outline Package (TSSOP), JEDEC MO-153, 4.4mm Wide Package Number MTC14

Physical Dimensions inches (millimeters) unless otherwise noted (Continued)

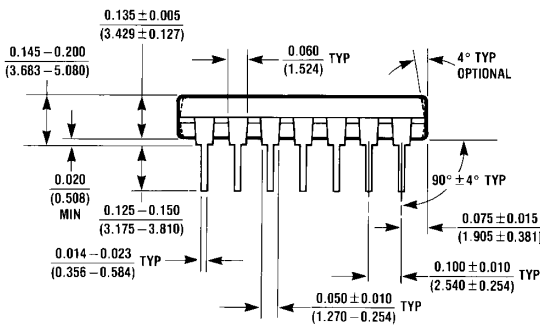
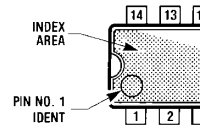
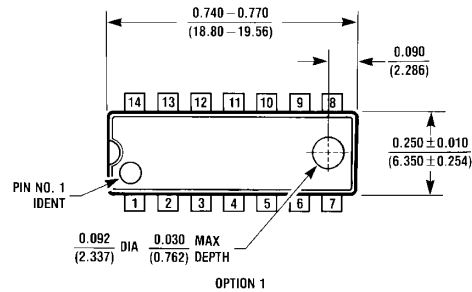

N14A (REV F)

14-Lead Plastic Dual-In-Line Package (PDIP), JEDEC MS-001, 0.300" Wide Package Number N14A

Fairchild does not assume any responsibility for use of any circuitry described, no circuit patent licenses are implied and Fairchild reserves the right at any time without notice to change said circuitry and specifications.

LIFE SUPPORT POLICY

FAIRCHILD'S PRODUCTS ARE NOT AUTHORIZED FOR USE AS CRITICAL COMPONENTS IN LIFE SUPPORT DEVICES OR SYSTEMS WITHOUT THE EXPRESS WRITTEN APPROVAL OF THE PRESIDENT OF FAIRCHILD SEMICONDUCTOR CORPORATION. As used herein:

1. Life support devices or systems are devices or systems which, (a) are intended for surgical implant into the body, or (b) support or sustain life, and (c) whose failure to perform when properly used in accordance with instructions for use provided in the labeling, can be reasonably expected to result in a significant injury to the user.
2. A critical component in any component of a life support device or system whose failure to perform can be reasonably expected to cause the failure of the life support device or system, or to affect its safety or effectiveness.

www.fairchildsemi.com