

FIN1028

3.3V LVDS 2-Bit High Speed Differential Receiver

General Description

This dual receiver is designed for high speed interconnects utilizing Low Voltage Differential Signaling (LVDS) technology. The receiver translates LVDS levels, with a typical differential input threshold of 100 mV, to LVTTTL signal levels. LVDS provides low EMI at ultra low power dissipation even at high frequencies. This device is ideal for high speed transfer of clock and data.

The FIN1028 can be paired with its companion driver, the FIN1027, or any other LVDS driver.

Features

- Greater than 400Mbps data rate
- 3.3V power supply operation
- 0.4ns maximum differential pulse skew
- 2.5ns maximum propagation delay
- Low power dissipation
- Power-Off protection
- Fail safe protection for open-circuit, shorted and terminated conditions
- Meets or exceeds the TIA/EIA-644 LVDS standard
- Flow-through pinout simplifies PCB layout
- 8-Lead SOIC and 8-terminal MLP packages save space

Ordering Code:

Order Number	Package Number	Package Description
FIN1028M (Note 1)	M08A	8-Lead Small Outline Integrated Circuit (SOIC), JEDEC MS-012, 0.150" Narrow
FIN1028MPX (Preliminary)	MLP08C	8-Terminal Molded Leadless Package (MLP) Dual, JEDEC MO-229, 2mm Square [TAPE and REEL]

Note 1: Devices also available in Tape and Reel. Specify by appending the suffix letter "X" to the ordering code.

Pin Descriptions

Pin Name	Description
R _{OUT1} , R _{OUT2}	LVTTTL Data Outputs
R _{IN1+} , R _{IN2+}	Non-inverting LVDS Inputs
R _{IN1-} , R _{IN2-}	Inverting LVDS Inputs
V _{CC}	Power Supply
GND	Ground

Function Table

Input	Outputs	
R _{IN+}	R _{IN+}	R _{OUT}
L	H	L
H	L	H
Fail Safe Condition		H

H = HIGH Logic Level
L = LOW Logic Level
Fail Safe = Open, Shorted, Terminated

Connection Diagrams

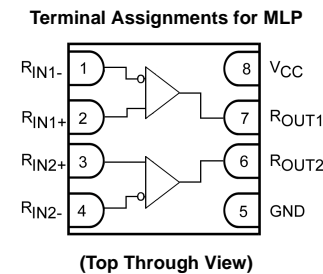
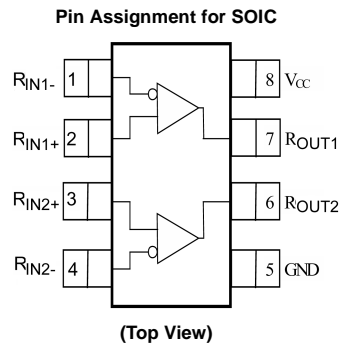

Absolute Maximum Ratings (Note 2)

Supply Voltage (V_{CC})	-0.5V to +4.6V
DC Input Voltage (R_{INx+} , R_{INx-})	-0.5V to +4.7V
DC Output Voltage (R_{OUTx})	-0.5V to +6V
DC Output Current (I_O)	16 mA
Storage Temperature Range (T_{STG})	-65°C to +150°C
Max Junction Temperature (T_J)	150°C
Lead Temperature (T_L) (Soldering, 10 seconds)	260°C
ESD (Human Body Model)	≥ 6500V
ESD (Machine Model)	≥ 300V

Recommended Operating Conditions

Supply Voltage (V_{CC})	3.0V to 3.6V
Input Voltage (V_{IN})	0 to V_{CC}
Magnitude of Differential Voltage ($ V_{ID} $)	100 mV to V_{CC}
Common-mode Input Voltage (V_{IC})	0.05V to 2.35V
Operating Temperature (T_A)	-40°C to +85°C

Note 2: The "Absolute Maximum Ratings" are those values beyond which damage to the device may occur. The databook specifications should be met, without exception, to ensure that the system design is reliable over its power supply, temperature and output/input loading variables. Fairchild does not recommend operation of circuits outside databook specification.

DC Electrical Characteristics

Over supply voltage and operating temperature ranges, unless otherwise specified

Symbol	Parameter	Test Conditions	Min	Typ (Note 3)	Max	Units
V_{TH}	Differential Input Threshold HIGH	See Figure 1 and Table 1			100	mV
V_{TL}	Differential Input Threshold LOW	See Figure 1 and Table 1	-100			mV
I_{IN}	Input Current	$V_{IN} = 0V$ or V_{CC}			±20	μA
$I_{I(OFF)}$	Power-OFF Input Current	$V_{CC} = 0V$, $V_{IN} = 0V$ or 3.6V			±20	μA
V_{OH}	Output HIGH Voltage	$I_{OH} = -100 \mu A$ $I_{OH} = -8 mA$	$V_{CC} - 0.2$ 2.4			V
V_{OL}	Output LOW Voltage	$I_{OH} = 100 \mu A$ $I_{OL} = 8 mA$			0.2 0.5	V
V_{IK}	Input Clamp Voltage	$I_{IK} = -18 mA$	-1.5			V
I_{CC}	Power Supply Current	($R_{IN+} = 1V$ and $R_{IN-} = 1.4V$) or ($R_{IN+} = 1.4V$ and $R_{IN-} = 1V$)			9	mA
C_{IN}	Input Capacitance			4		pF
C_{OUT}	Output Capacitance			6		pF

Note 3: All typical values are at $T_A = 25^\circ C$ and with $V_{CC} = 3.3V$.

AC Electrical Characteristics

Over supply voltage and operating temperature ranges, unless otherwise specified

Symbol	Parameter	Test Conditions	Min	Typ (Note 4)	Max	Units
t_{PLH}	Differential Propagation Delay LOW-to-HIGH	$ V_{ID} = 400 mV$, $C_L = 10 pF$, See Figure 1 and Figure 2	0.9		2.5	ns
t_{PHL}	Differential Propagation Delay HIGH-to-LOW		0.9		2.5	ns
t_{TLH}	Output Rise Time (20% to 80%)			0.5		ns
t_{THL}	Output Fall Time (80% to 20%)			0.5		ns
$t_{SK(P)}$	Pulse Skew $ t_{PLH} - t_{PHL} $				0.4	ns
$t_{SK(LH)}$, $t_{SK(HL)}$	Channel-to-Channel Skew (Note 5)				0.3	ns
$t_{SK(PP)}$	Part-to-Part Skew (Note 6)				1.0	ns

Note 4: All typical values are at $T_A = 25^\circ C$ and with $V_{CC} = 3.3V$.

Note 5: $t_{SK(LH)}$, $t_{SK(HL)}$ is the skew between specified outputs of a single device when the outputs have identical loads and are switching in the same direction.

Note 6: $t_{SK(PP)}$ is the magnitude of the difference in propagation delay times between any specified terminals of two devices switching in the same direction (either LOW-to-HIGH or HIGH-to-LOW) when both devices operate with the same supply voltage, same temperature, and have identical test circuits.

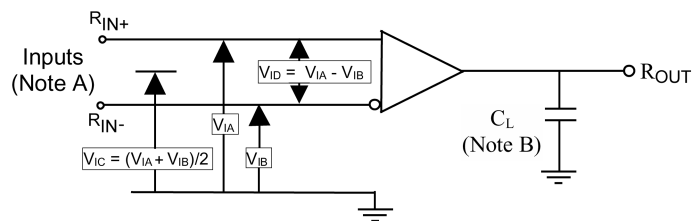

Note A: All input pulses have frequency = 10 MHz, t_R or $t_F = 1$ ns
Note B: C_L includes all probe and fixture capacitances

FIGURE 1. Differential Driver Propagation Delay and Transition Time Test Circuit

TABLE 1. Receiver Minimum and Maximum Input Threshold Test Voltages

Applied Voltages (V)		Resulting Differential Input Voltage (mV)	Resulting Common Mode Input Voltage (V)
V_{IA}	V_{IB}	V_{ID}	V_{IC}
1.25	1.15	100	1.2
1.15	1.25	-100	1.2
2.4	2.3	100	2.35
2.3	2.4	-100	2.35
0.1	0	100	0.05
0	0.1	-100	0.05
1.5	0.9	600	1.2
0.9	1.5	-600	1.2
2.4	1.8	600	2.1
1.8	2.4	-600	2.1
0.6	0	600	0.3
0	0.6	-600	0.3

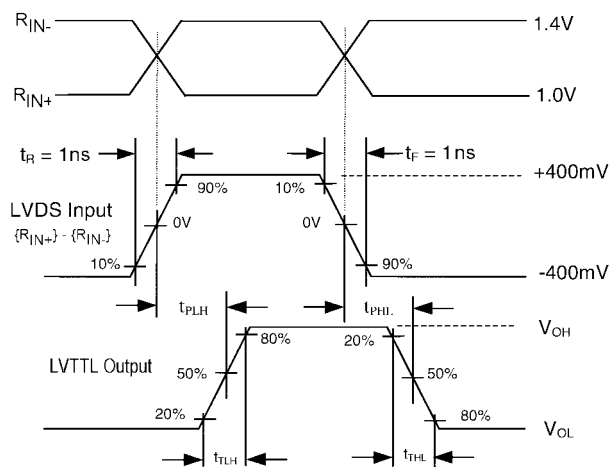

FIGURE 2. AC Waveforms

DC / AC Typical Performance Curves

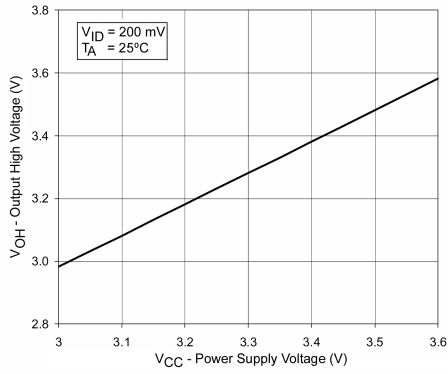

FIGURE 3. Output High Voltage vs. Power Supply Voltage

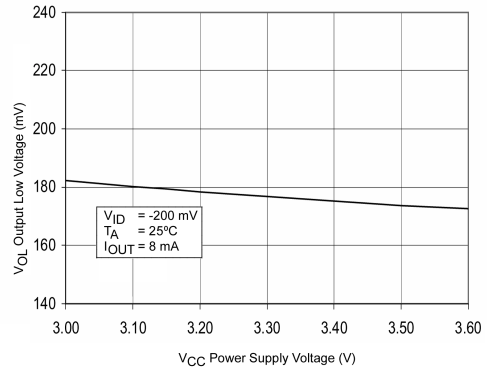

FIGURE 4. Output Low Voltage vs. Power Supply Voltage

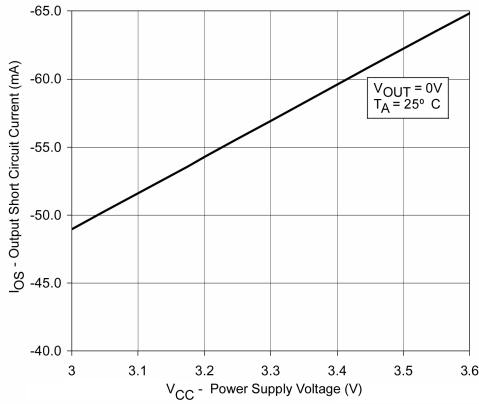

FIGURE 5. Output Short Circuit Current vs. Power Supply Voltage

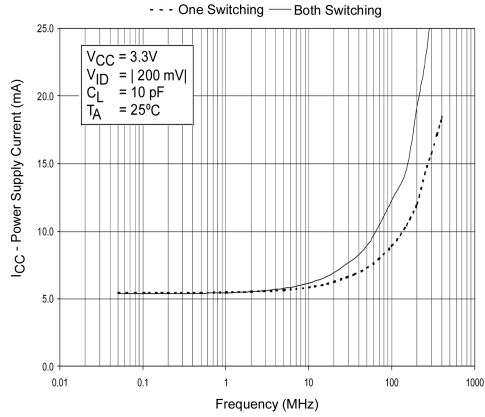

FIGURE 6. Power Supply Current vs. Frequency

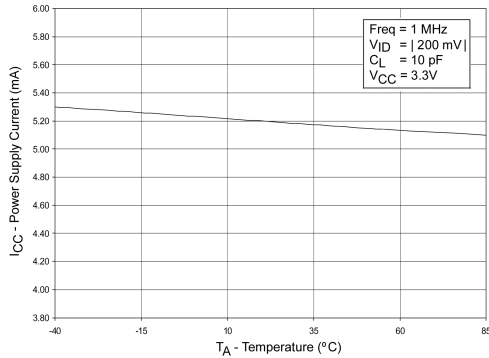

FIGURE 7. Power Supply Current vs. Ambient Temperature

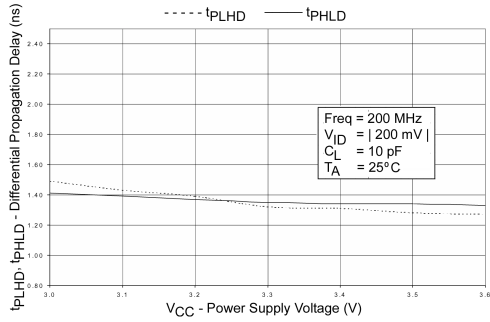

FIGURE 8. Differential Propagation Delay vs. Power Supply Voltage

DC /AC Typical Performance Curves (Continued)

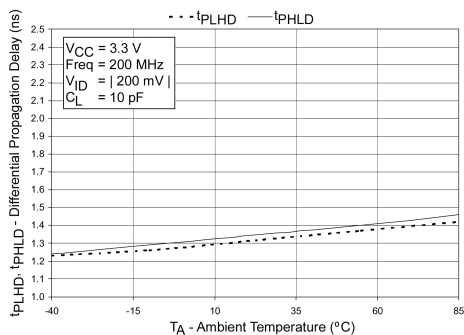

FIGURE 9. Differential Propagation Delay vs. Ambient Temperature

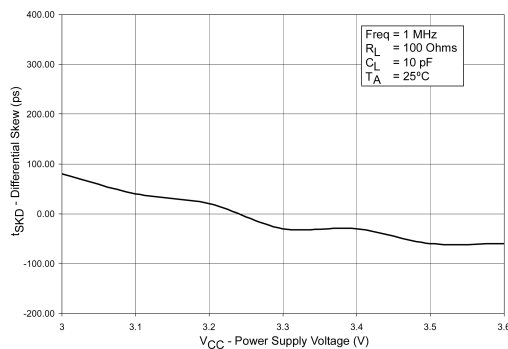

FIGURE 10. Differential Skew ($t_{PLH} - t_{PHL}$) vs. Power Supply Voltage

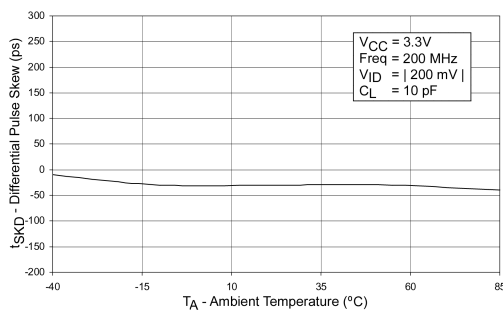

FIGURE 11. Differential Skew ($t_{PHL} - t_{PLH}$) vs. Ambient Temperature

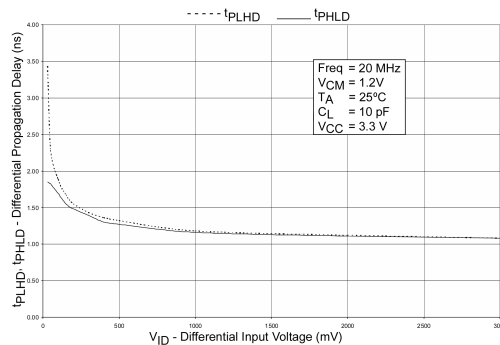

FIGURE 12. Differential Propagation Delay vs. Differential Input Voltage

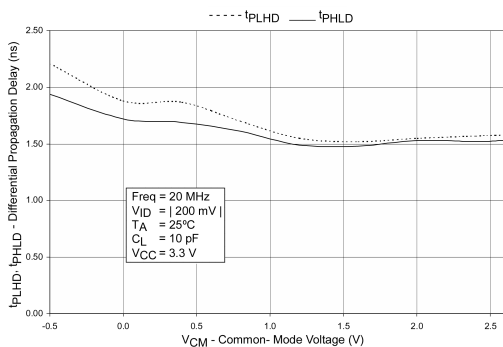

FIGURE 13. Differential Propagation Delay vs. Common-Mode Voltage

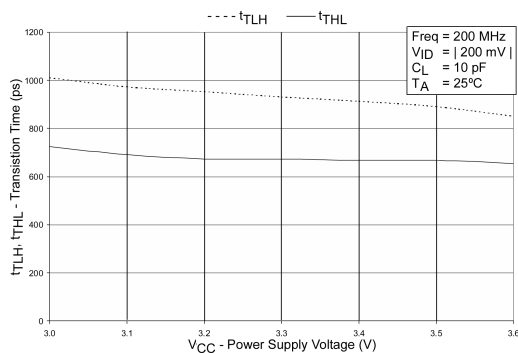

FIGURE 14. Transition Time vs. Power Supply Voltage

DC /AC Typical Performance Curves (Continued)

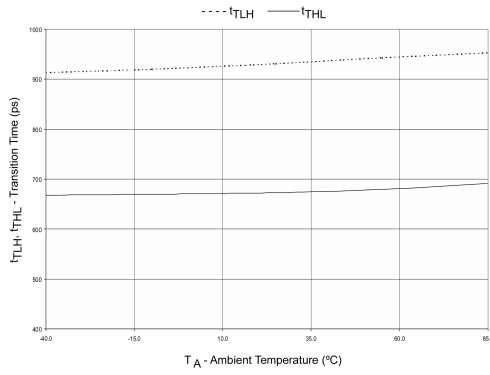

FIGURE 15. Transition Time vs. Ambient Temperature

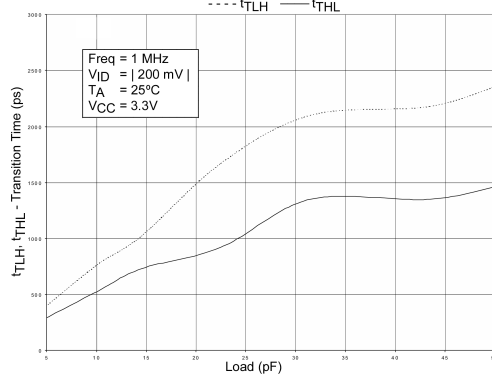

FIGURE 16. Differential Propagation Delay vs. Load

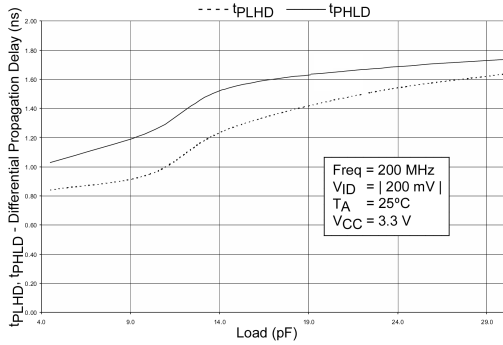

FIGURE 17. Differential Propagation Delay vs. Load

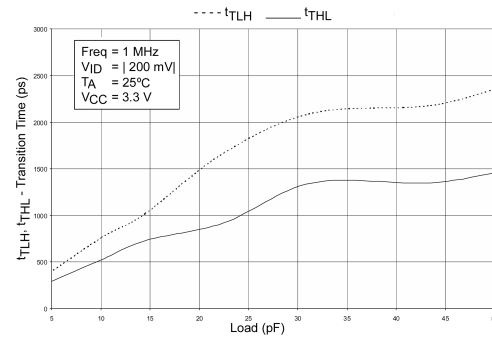

FIGURE 18. Transition Time vs. Load

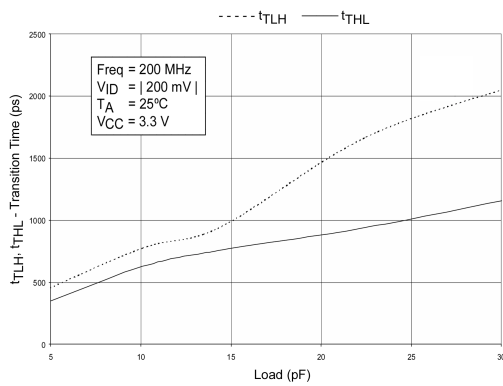

FIGURE 19. Transition Time vs. Load

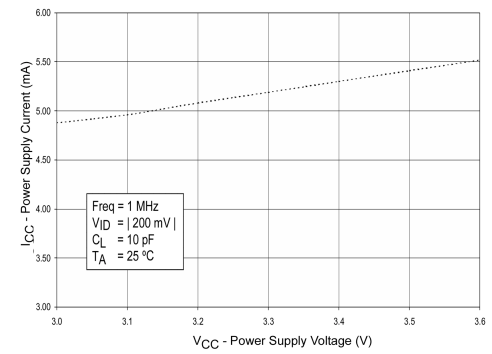

FIGURE 20. Power Supply Current vs. Power Supply Voltage

Tape and Reel Specification

TAPE FORMAT for MLP

Package	Ao	Bo	D	D ₁	E	F	Ko	P ₁	Po	P ₂	T	T _C	W	Wc
	±0.10	±0.10	±0.05	Min	±0.1	±0.1	±0.1	TYP	TYP	±0/05	TYP	±0.005	±0.3	TYP
2 x 2	2.30	2.30	1.55	1.0	1.75	3.5	1.0	8.0	4.0	2.0	0.3	0.06	8.0	5.3

MLP Embossed Tape Dimensions (Dimensions are in millimeters)

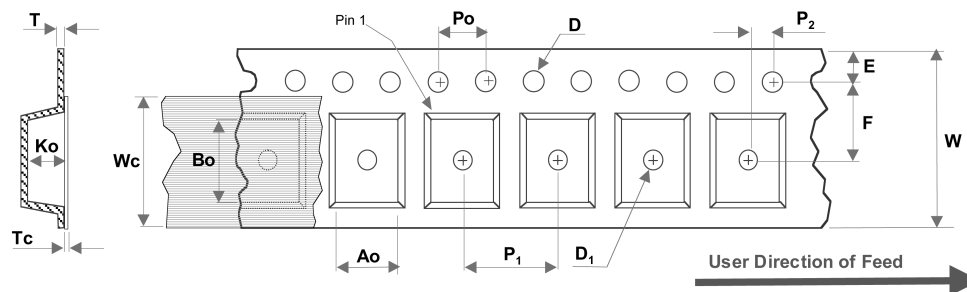

REEL DIMENSIONS (millimeters)

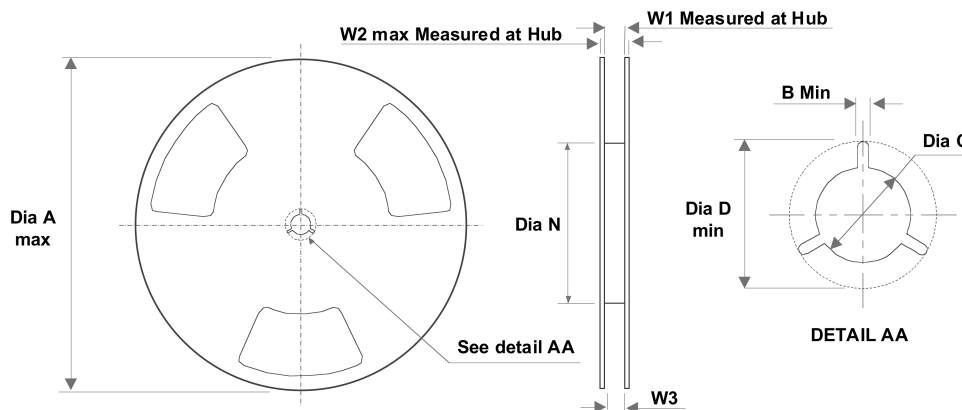

Tape Width	Dia A Max	Dim B Min	Dia C +0.5/-0.2	Dia D Min	Dim N Min	Dim W1 +2/-0	Dim W2 Max	Dim W3 (LSL - USL)
8 mm	330	1.5	13	20.2	178	8.4	14.4	7.9 ~ 10.4

Physical Dimensions inches (millimeters) unless otherwise noted

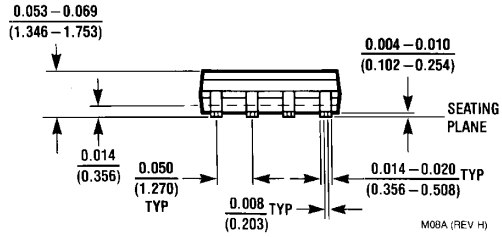
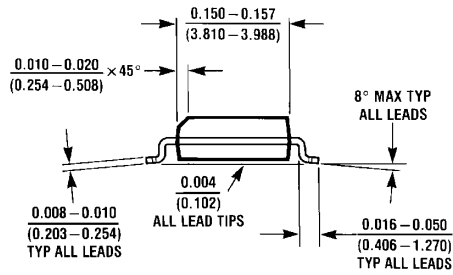
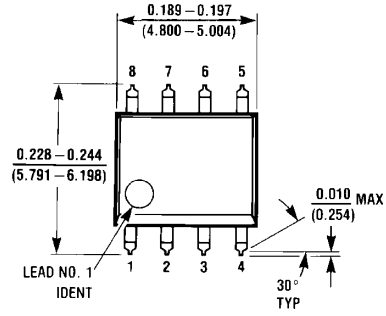

8-Lead Small Outline Integrated Circuit (SOIC), JEDEC MS-012, 0.150" Narrow Package Number M08A

Physical Dimensions inches (millimeters) unless otherwise noted (Continued)

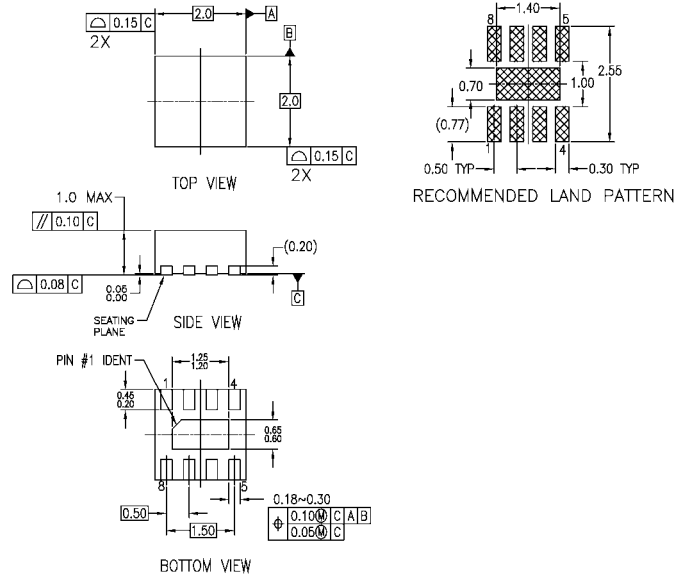

NOTES:

- A. CONFORMS TO JEDEC REGISTRATION MO-229, VARIATION VCCD-3, DATED 11/2001
- B. DIMENSIONS ARE IN MILLIMETERS.
- C. DIMENSIONS AND TOLERANCES PER ASME Y14.5M, 1994

MLP08CrevB

8-Terminal Molded Leadless Package (MLP) Dual, JEDEC MO-229, 2mm Square Package Number MLP08C (Preliminary)

Fairchild does not assume any responsibility for use of any circuitry described, no circuit patent licenses are implied and Fairchild reserves the right at any time without notice to change said circuitry and specifications.

LIFE SUPPORT POLICY

FAIRCHILD'S PRODUCTS ARE NOT AUTHORIZED FOR USE AS CRITICAL COMPONENTS IN LIFE SUPPORT DEVICES OR SYSTEMS WITHOUT THE EXPRESS WRITTEN APPROVAL OF THE PRESIDENT OF FAIRCHILD SEMICONDUCTOR CORPORATION. As used herein:

1. Life support devices or systems are devices or systems which, (a) are intended for surgical implant into the body, or (b) support or sustain life, and (c) whose failure to perform when properly used in accordance with instructions for use provided in the labeling, can be reasonably expected to result in a significant injury to the user.
2. A critical component in any component of a life support device or system whose failure to perform can be reasonably expected to cause the failure of the life support device or system, or to affect its safety or effectiveness.

www.fairchildsemi.com