

**FAST SOFT RECOVERY
RECTIFIER DIODE**

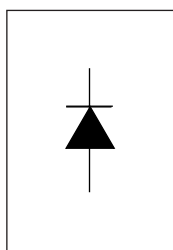

$I_{F(RMS)}$	= 160A
V_F	< 1.4V @ 100A
t_{rr}	= 95ns
V_{RRM}	800 to 1200V

Description/Features

The 85EPF.. fast soft recovery **QUIETIR** rectifier series has been optimized for combined short reverse recovery time and low forward voltage drop.

The glass passivation ensures stable reliable operation in the most severe temperature and power cycling conditions.

Available in the new **PowIRtab™** package, this new series is suitable for a large range of applications combining excellent die to footprint ratio and sturdiness connectivity for use in high current environments.

Typical applications are both:

- Output rectification and freewheeling in inverters, choppers and converters
- Input rectifications where severe restrictions on conducted EMI should be met.

Major Ratings and Characteristics

Characteristics	85EPF..	Units
$I_{F(AV)}$ Rect. Conduction 50% duty Cycle @ $T_c = 85^\circ\text{C}$	85	A
$I_{F(RMS)}$	160	A
V_{RRM} range	800 to 1200	V
I_{FSM}	1100	A
V_F @ 100A, $T_J = 25^\circ\text{C}$	1.4	V
t_{rr} @ 1A, -100A/ μs	95	ns
T_J range	-40 to 150	$^\circ\text{C}$

Package Outline

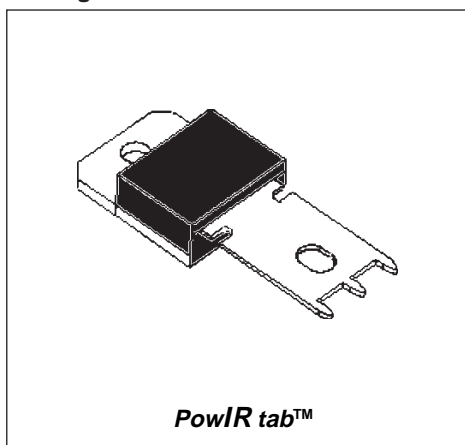

85EPF.. HV QUIET^{IR} Series

Preliminary Data Sheet I2153 rev. B 11/98

International
IGR Rectifier

Voltage Ratings

Part Number	V_{RRM} , maximum peak reverse voltage V	V_{RSM} , maximum non repetitive peak reverse voltage V	I_{RRM} 150°C mA
85EPF08	800	900	15
85EPF10	1000	1100	
85EPF12	1200	1300	

Absolute Maximum Ratings

Parameters	85EPF..	Units	Conditions
$I_{F(AV)}$ Max. Average Forward Current	85	A	@ $T_C = 85^\circ\text{C}$, 180° conduction half sine wave
I_{FSM} Max. Peak One Cycle Non-Repetitive Surge Current	1100	A	10ms Sine pulse, rated V_{RRM} applied
	1250		10ms Sine pulse, no voltage reapplied
I^2t Max. I^2t for fusing	5000	A^2s	10ms Sine pulse, rated V_{RRM} applied
	7000		10ms Sine pulse, no voltage reapplied
$I^2\sqrt{t}$ Max. $I^2\sqrt{t}$ for fusing	70000	$A^2\sqrt{s}$	$t = 0.1$ to 10ms, no voltage reapplied

Electrical Specifications

Parameters	85EPF..	Units	Conditions
V_{FM} Max. Forward Voltage Drop	1.36	V	@ 85A, $T_J = 25^\circ\text{C}$
r_t Forward slope resistance	4.03	$m\Omega$	$T_J = 150^\circ\text{C}$
$V_{F(TO)}$ Threshold voltage	0.87	V	
I_{RM} Max. Reverse Leakage Current	0.1	mA	$T_J = 25^\circ\text{C}$
	15		$T_J = 150^\circ\text{C}$

$V_R = \text{rated } V_{RRM}$

Recovery Characteristics

Parameters	85EPF..	Units	Conditions
t_{rr} Reverse Recovery Time	480	ns	$I_F @ 85\text{Apk}$ @ 25A/ μs @ 25°C
I_{rr} Reverse Recovery Current	7.1	A	
Q_{rr} Reverse Recovery Charge	2.1	μC	@ 25°C
S Snap Factor	0.5		

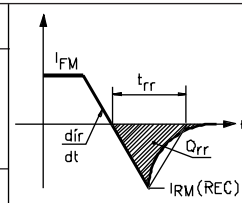

Thermal-Mechanical Specifications

Parameters		85EPF..	Units	Conditions
T_J	Max. Junction Temperature Range	-40 to 150	°C	
T_{stg}	Max. Storage Temperature Range	-40 to 150	°C	
R_{thJC}	Max. Thermal Resistance Junction to Case	0.35	°C/W	DC operation
R_{thJA}	Max. Thermal Resistance Junction to Ambient	40	°C/W	
R_{thCS}	Typical Thermal Resistance, Case to Heatsink	0.2	°C/W	Mounting surface, smooth and greased
wt	Approximate Weight	6(0.21)	g(oz.)	
T	Mounting Torque	Min.	6(5)	Kg-cm (lbf-in)
		Max.	12(10)	
Case Style		TO-247AC	JEDEC	

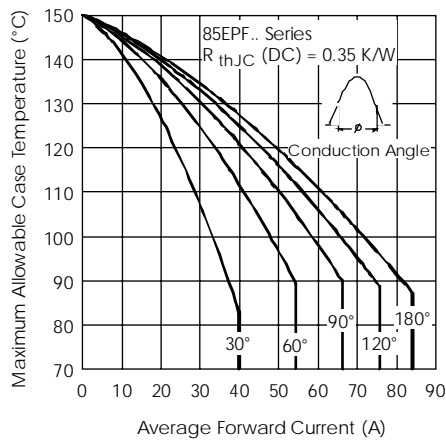

Fig. 1 - Current Rating Characteristics

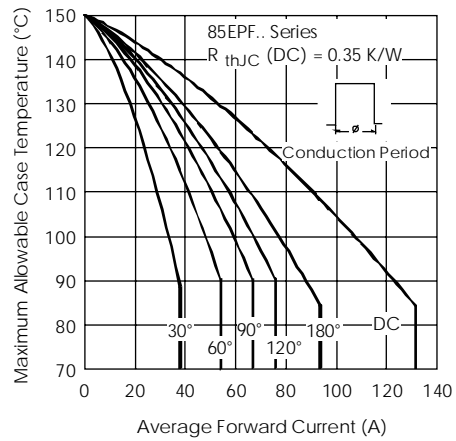

Fig. 2 - Current Rating Characteristics

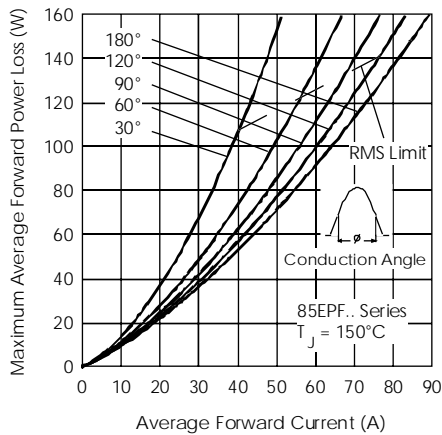

Fig. 3 - Forward Power Loss Characteristics

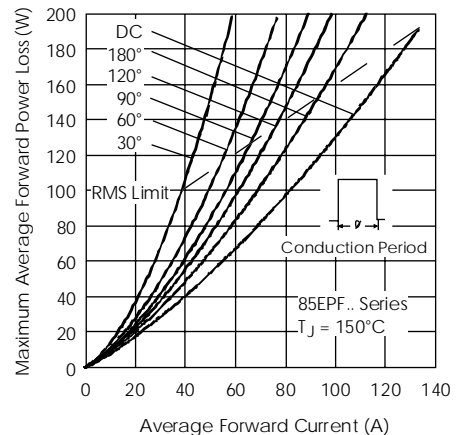

Fig. 4 - Forward Power Loss Characteristics

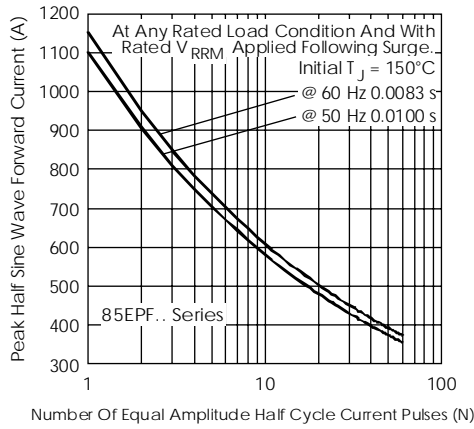

Fig.5-Maximum Non-Repetitive Surge Current

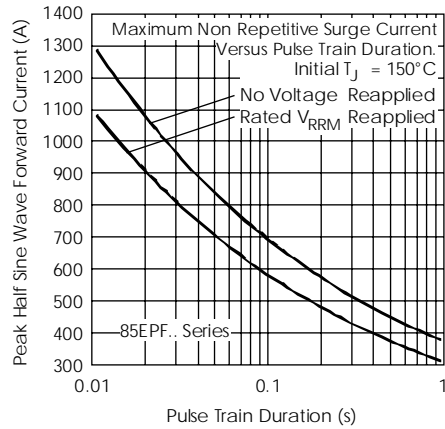

Fig.6-Maximum Non-Repetitive Surge Current

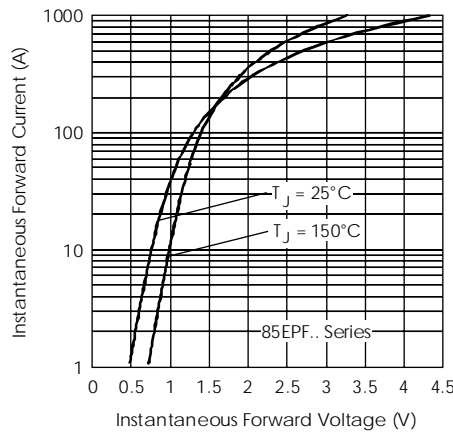

Fig.7-Forward Voltage Drop Characteristics

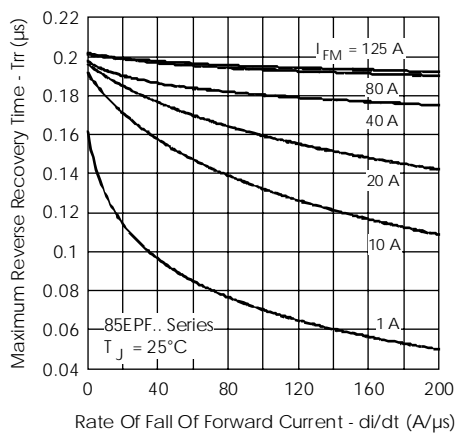

Fig.8-Recovery Time Characteristics, $T_J = 25^\circ\text{C}$

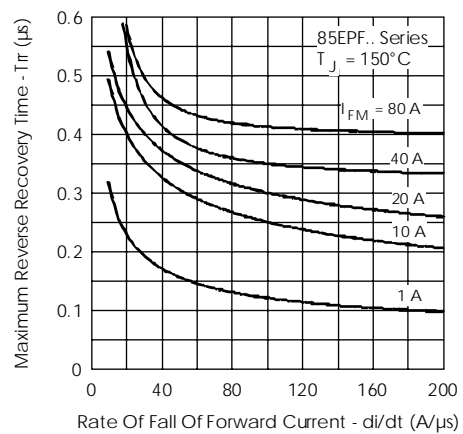

Fig.9-Recovery Time Characteristics, $T_J = 150^\circ\text{C}$

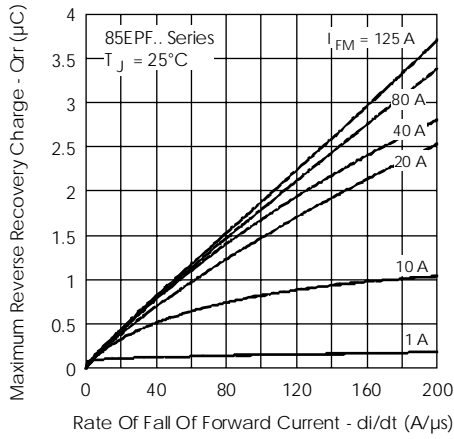

Fig. 10-Recovery Charge Characteristics, $T_J = 25^\circ\text{C}$

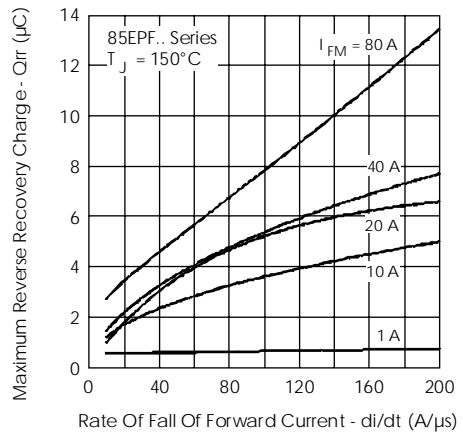

Fig. 11-Recovery Charge Characteristics, $T_J = 150^\circ\text{C}$

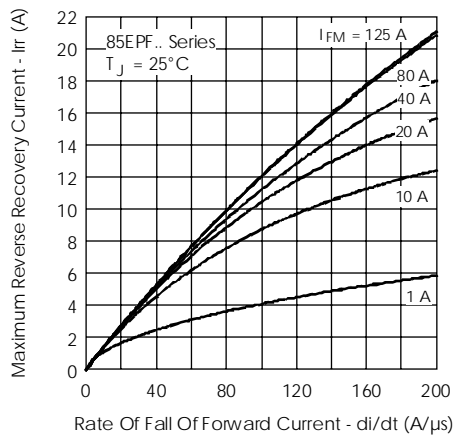

Fig. 12-Recovery Current Characteristics, $T_J = 25^\circ\text{C}$

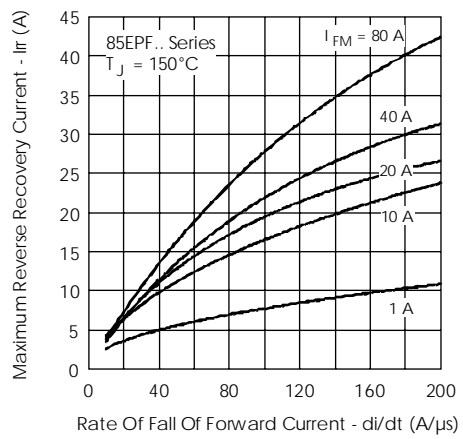

Fig. 13-Recovery Current Characteristics, $T_J = 150^\circ\text{C}$

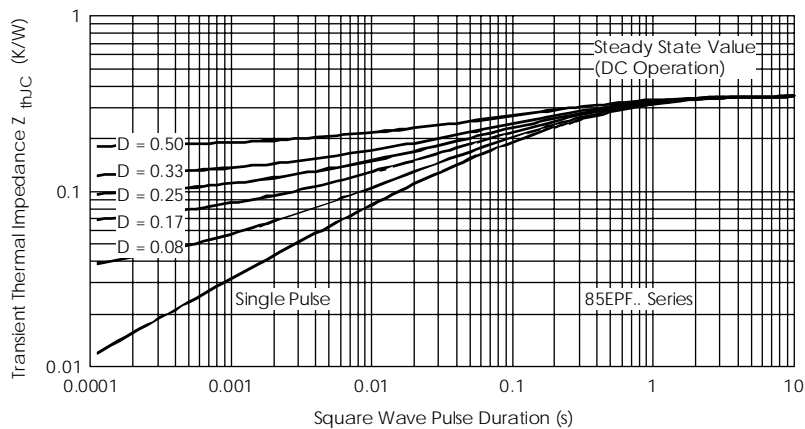
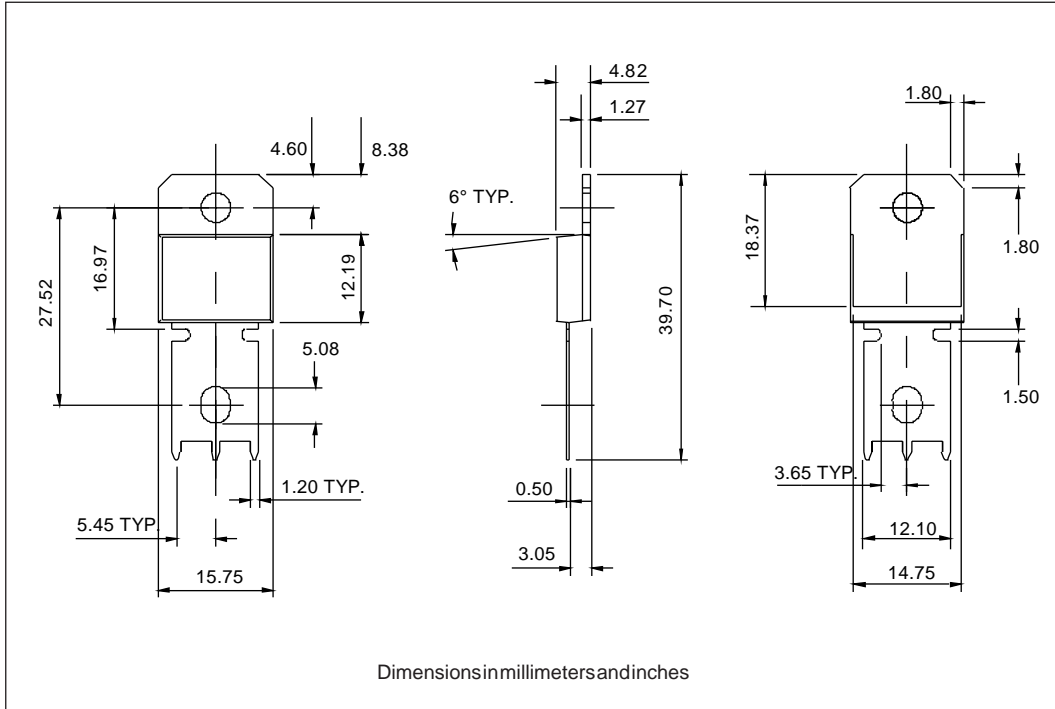
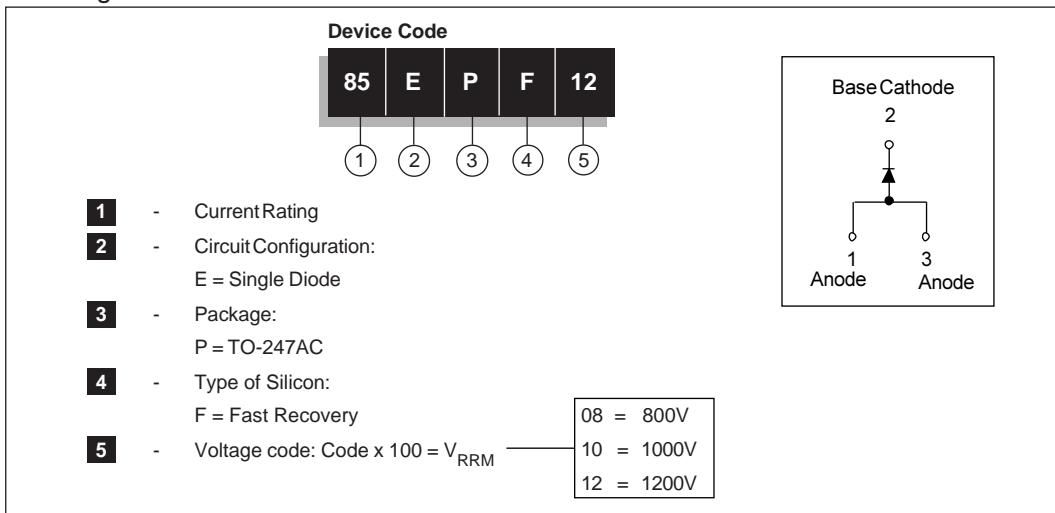

Fig. 14-Thermal Impedance Z_{thJC} Characteristics

Outline Table



Ordering Information Table



WORLD HEADQUARTERS: 233 Kansas St., El Segundo, California 90245 U.S.A. Tel: (310) 322 3331. Fax: (310) 322 3332.
EUROPEAN HEADQUARTERS: Hurst Green, Oxted, Surrey RH8 9BB, U.K. Tel: ++ 44 1883 732020. Fax: ++ 44 1883 733408.
IR CANADA: 15 Lincoln Court, Brampton, Markham, Ontario L6T3Z2. Tel: (905) 453 2200. Fax: (905) 475 8801.
IR GERMANY: Saalburgstrasse 157, 61350 Bad Homburg. Tel: ++ 49 6172 96590. Fax: ++ 49 6172 965933.
IR ITALY: Via Liguria 49, 10071 Borgaro, Torino. Tel: ++ 39 11 4510111. Fax: ++ 39 11 4510220.
IR FAR EAST: K&H Bldg., 2F, 30-4 Nishi-Ikebukuro 3-Chome, Toshima-Ku, Tokyo, Japan 171. Tel: 81 3 3983 0086.
IR SOUTHEAST ASIA: 1 Kim Seng Promenade, Great World City West Tower, 13-11, Singapore 237994. Tel: ++ 65 838 4630.
IR TAIWAN: 16 Fl. Suite D.207, Sec. 2, Tun Haw South Road, Taipei, 10673, Taiwan. Tel: 886 2 2377 9936.