

- Advanced Process Technology
- Isolated Package
- High Voltage Isolation = 2.5KVRMS ⑤
- Sink to Lead Creepage Dist. = 4.8mm
- Fully Avalanche Rated

Description

Fifth Generation HEXFETs from International Rectifier utilize advanced processing techniques to achieve extremely low on-resistance per silicon area. This benefit, combined with the fast switching speed and ruggedized device design that HEXFET Power MOSFETs are well known for, provides the designer with an extremely efficient and reliable device for use in a wide variety of applications.

The TO-220 Fullpak eliminates the need for additional insulating hardware in commercial-industrial applications. The moulding compound used provides a high isolation capability and a low thermal resistance between the tab and external heatsink. This isolation is equivalent to using a 100 micron mica barrier with standard TO-220 product. The Fullpak is mounted to a heatsink using a single clip or by a single screw fixing.

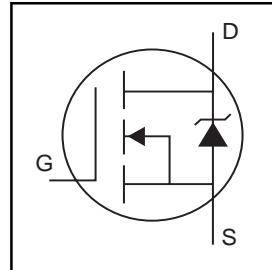

$V_{DSS} = 100V$
$R_{DS(on)} = 0.036\Omega$
$I_D = 24A$

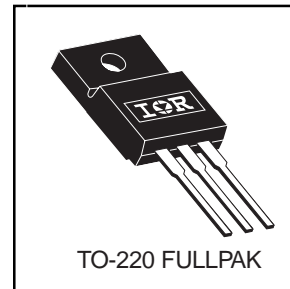

Absolute Maximum Ratings

	Parameter	Max.	Units
$I_D @ T_C = 25^\circ C$	Continuous Drain Current, $V_{GS} @ 10V$	24	A
$I_D @ T_C = 100^\circ C$	Continuous Drain Current, $V_{GS} @ 10V$	17	
I_{DM}	Pulsed Drain Current ①⑥	140	
$P_D @ T_C = 25^\circ C$	Power Dissipation	56	W
	Linear Derating Factor	0.37	W/°C
V_{GS}	Gate-to-Source Voltage	± 20	V
E_{AS}	Single Pulse Avalanche Energy②⑥	420	mJ
I_{AR}	Avalanche Current①⑥	22	A
E_{AR}	Repetitive Avalanche Energy①	5.6	mJ
d_v/d_t	Peak Diode Recovery dv/dt ③⑥	5.0	V/ns
T_J	Operating Junction and Storage Temperature Range	-55 to + 175	°C
T_{STG}			
	Mounting torque, 6-32 or M3 screw	10 lbf•in (1.1N•m)	

Thermal Resistance

	Parameter	Typ.	Max.	Units
$R_{\theta JC}$	Junction-to-Case	—	2.7	°C/W
$R_{\theta JA}$	Junction-to-Ambient	—	65	

Electrical Characteristics @ $T_J = 25^\circ\text{C}$ (unless otherwise specified)

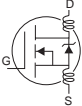
	Parameter	Min.	Typ.	Max.	Units	Conditions
$V_{(BR)DSS}$	Drain-to-Source Breakdown Voltage	100	—	—	V	$V_{GS} = 0V, I_D = 250\mu A$
$\Delta V_{(BR)DSS}/\Delta T_J$	Breakdown Voltage Temp. Coefficient	—	0.11	—	V/ $^\circ\text{C}$	Reference to $25^\circ\text{C}, I_D = 1\text{mA}$ ⑥
$R_{DS(on)}$	Static Drain-to-Source On-Resistance	—	—	0.036	Ω	$V_{GS} = 10V, I_D = 13A$ ④
$V_{GS(th)}$	Gate Threshold Voltage	2.0	—	4.0	V	$V_{DS} = V_{GS}, I_D = 250\mu A$
g_{fs}	Forward Transconductance	14	—	—	S	$V_{DS} = 25V, I_D = 22A$ ⑥
I_{DSS}	Drain-to-Source Leakage Current	—	—	25	μA	$V_{DS} = 100V, V_{GS} = 0V$
		—	—	250		$V_{DS} = 80V, V_{GS} = 0V, T_J = 150^\circ\text{C}$
I_{GSS}	Gate-to-Source Forward Leakage	—	—	100	nA	$V_{GS} = 20V$
	Gate-to-Source Reverse Leakage	—	—	-100		$V_{GS} = -20V$
Q_g	Total Gate Charge	—	—	120	nC	$I_D = 22A$
Q_{gs}	Gate-to-Source Charge	—	—	15		$V_{DS} = 80V$
Q_{gd}	Gate-to-Drain ("Miller") Charge	—	—	58		$V_{GS} = 10V$, See Fig. 6 and 13 ④ ⑥
$t_{d(on)}$	Turn-On Delay Time	—	11	—	ns	$V_{DD} = 50V$
t_r	Rise Time	—	56	—		$I_D = 22A$
$t_{d(off)}$	Turn-Off Delay Time	—	45	—		$R_G = 3.6\Omega$
t_f	Fall Time	—	40	—		$R_D = 2.9\Omega$, See Fig. 10 ④ ⑥
L_D	Internal Drain Inductance	—	4.5	—	nH	Between lead, 6mm (0.25in.) from package and center of die contact
L_S	Internal Source Inductance	—	7.5	—		
C_{iss}	Input Capacitance	—	1900	—	pF	$V_{GS} = 0V$
C_{oss}	Output Capacitance	—	450	—		$V_{DS} = 25V$
C_{rss}	Reverse Transfer Capacitance	—	230	—		$f = 1.0\text{MHz}$, See Fig. 5 ⑥
C	Drain to Sink Capacitance	—	12	—		$f = 1.0\text{MHz}$

Source-Drain Ratings and Characteristics

	Parameter	Min.	Typ.	Max.	Units	Conditions
I_S	Continuous Source Current (Body Diode)	—	—	24	A	MOSFET symbol showing the integral reverse p-n junction diode.
I_{SM}	Pulsed Source Current (Body Diode) ① ⑥	—	—	140		
V_{SD}	Diode Forward Voltage	—	—	1.3	V	$T_J = 25^\circ\text{C}, I_S = 13A, V_{GS} = 0V$ ④
t_{rr}	Reverse Recovery Time	—	180	270	ns	$T_J = 25^\circ\text{C}, I_F = 22A$
Q_{rr}	Reverse Recovery Charge	—	1.2	1.8	μC	$di/dt = 100A/\mu s$ ④ ⑥
t_{on}	Forward Turn-On Time	Intrinsic turn-on time is negligible (turn-on is dominated by L_S+L_D)				

Notes:

- ① Repetitive rating; pulse width limited by max. junction temperature. (See fig. 11)
- ② Starting $T_J = 25^\circ\text{C}$, $L = 1.0\text{mH}$
 $R_G = 25\Omega, I_{AS} = 22A$. (See Figure 12)
- ③ $I_{SD} \leq 22A, di/dt \leq 180A/\mu s, V_{DD} \leq V_{(BR)DSS}, T_J \leq 175^\circ\text{C}$
- ④ Pulse width $\leq 300\mu s$; duty cycle $\leq 2\%$.
- ⑤ $t = 60s, f = 60\text{Hz}$
- ⑥ Uses IRF11310N data and test conditions

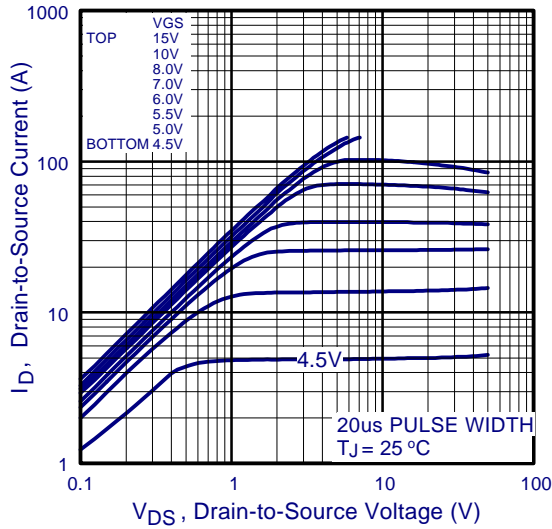

Fig 1. Typical Output Characteristics

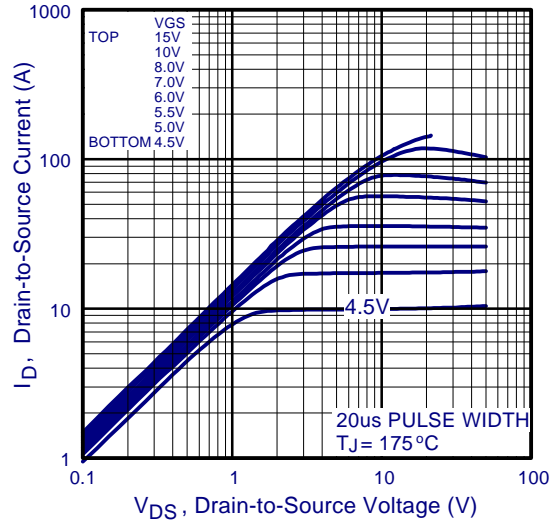

Fig 2. Typical Output Characteristics

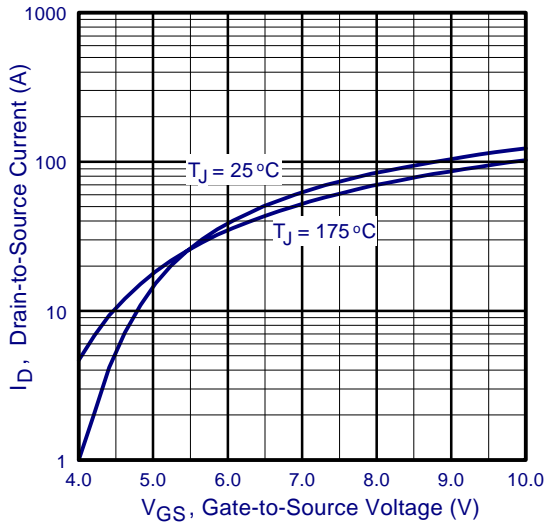

Fig 3. Typical Transfer Characteristics

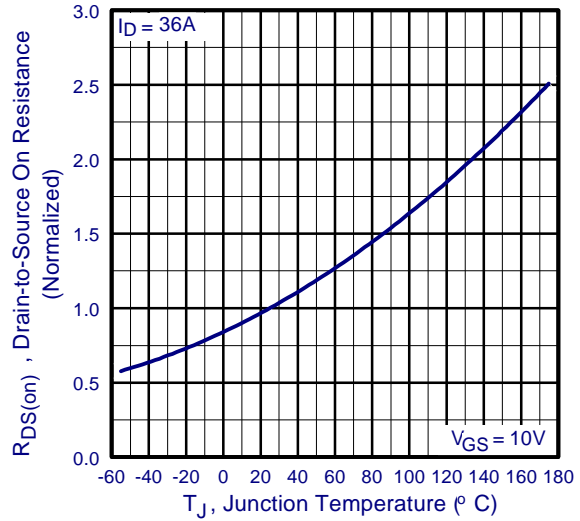

Fig 4. Normalized On-Resistance Vs. Temperature

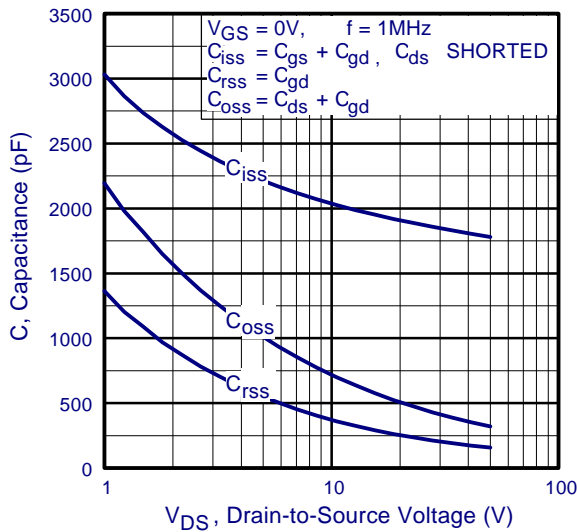

Fig 5. Typical Capacitance Vs. Drain-to-Source Voltage

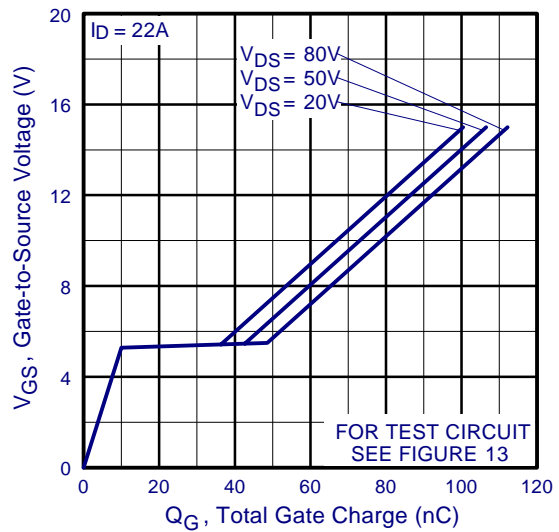

Fig 6. Typical Gate Charge Vs. Gate-to-Source Voltage

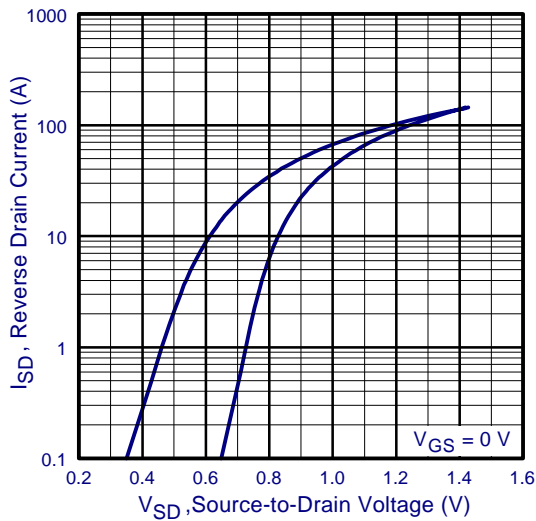

Fig 7. Typical Source-Drain Diode Forward Voltage

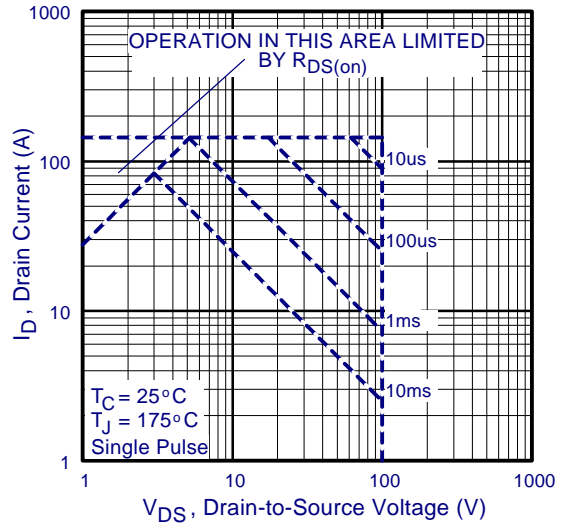

Fig 8. Maximum Safe Operating Area

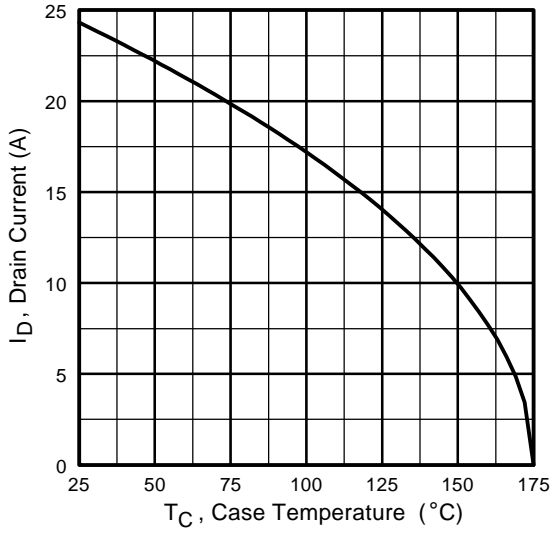

Fig 9. Maximum Drain Current Vs. Case Temperature

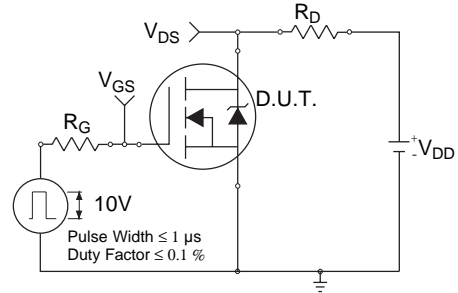

Fig 10a. Switching Time Test Circuit

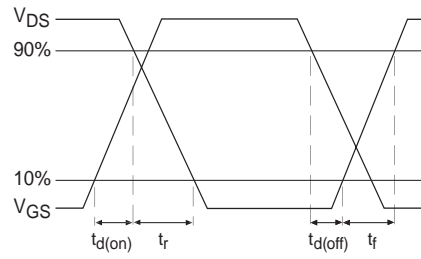

Fig 10b. Switching Time Waveforms

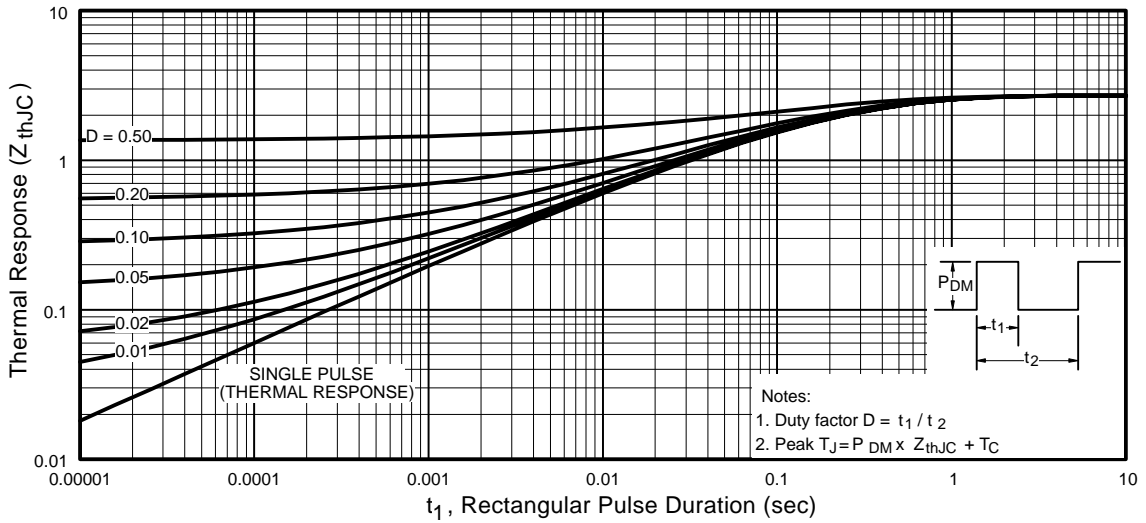

Fig 11. Maximum Effective Transient Thermal Impedance, Junction-to-Case

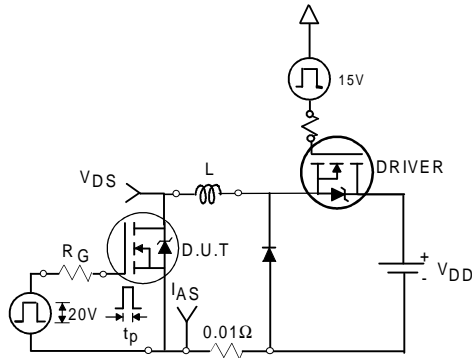

Fig 12a. Unclamped Inductive Test Circuit

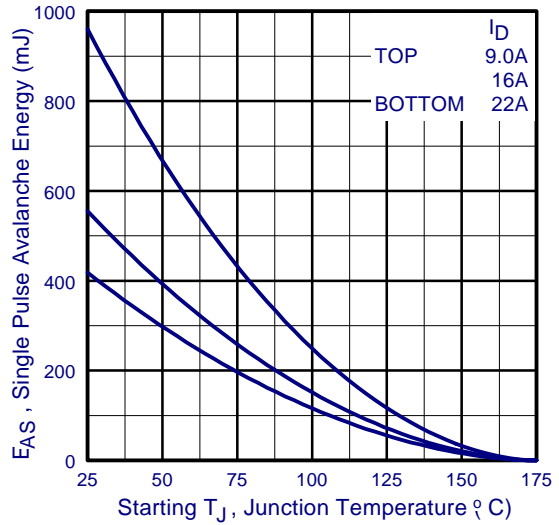

Fig 12c. Maximum Avalanche Energy Vs. Drain Current

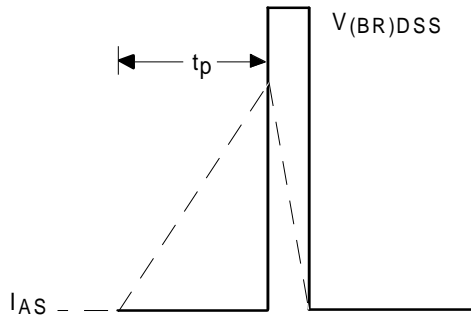

Fig 12b. Unclamped Inductive Waveforms

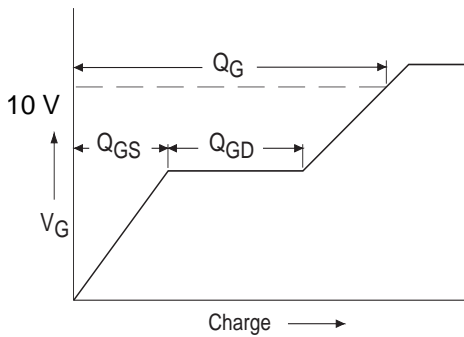

Fig 13a. Basic Gate Charge Waveform

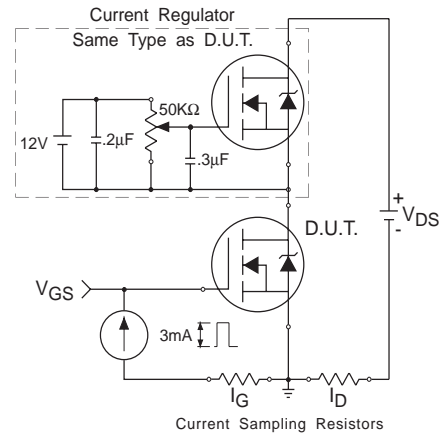
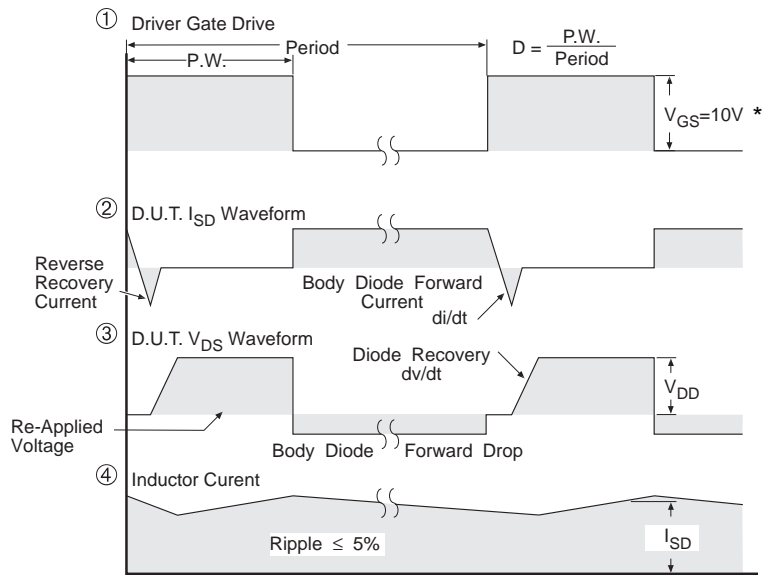
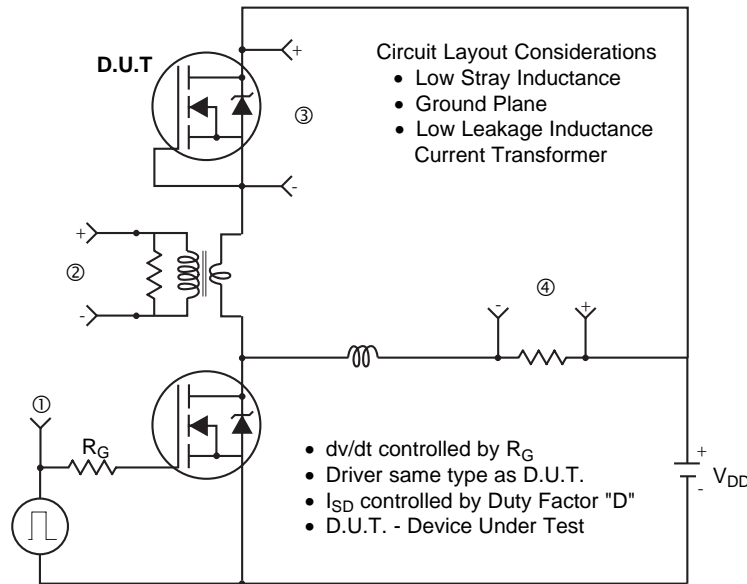

Fig 13b. Gate Charge Test Circuit

Peak Diode Recovery dv/dt Test Circuit



* $V_{GS} = 5V$ for Logic Level Devices

Fig 14. For N-Channel HEXFETS

IRFI1310N

International
IR Rectifier

Package Outline TO-220 Fullpak Outline

Dimensions are shown in millimeters (inches)

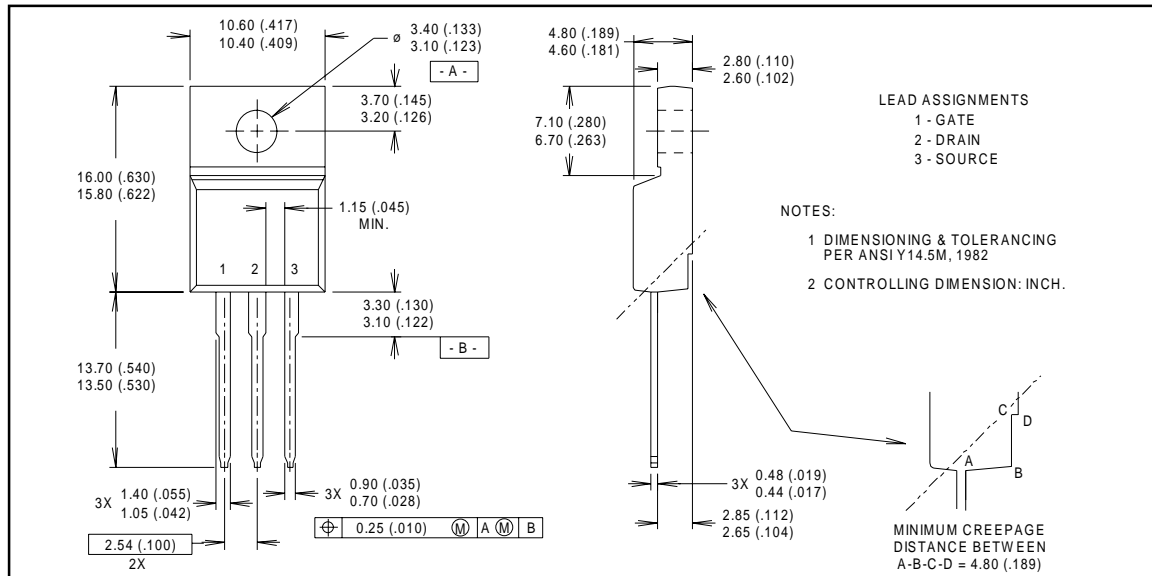

Part Marking Information

TO-220 Fullpak

EXAMPLE : THIS IS AN IRFI840G
WITH ASSEMBLY
LOT CODE E401

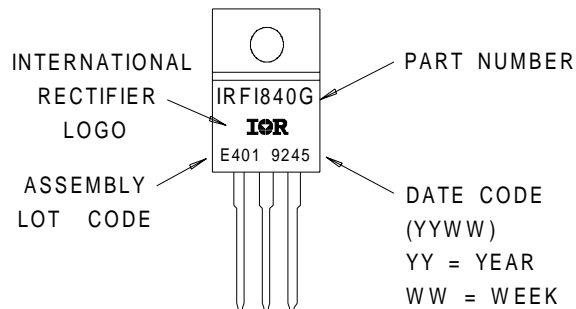

International
IR Rectifier

WORLD HEADQUARTERS: 233 Kansas St., El Segundo, California 90245, Tel: (310) 322 3331

EUROPEAN HEADQUARTERS: Hurst Green, Oxted, Surrey RH8 9BB, UK Tel: ++ 44 1883 732020

IR CANADA: 7321 Victoria Park Ave., Suite 201, Markham, Ontario L3R 2Z8, Tel: (905) 475 1897

IR GERMANY: Saalburgstrasse 157, 61350 Bad Homburg Tel: ++ 49 6172 96590

IR ITALY: Via Liguria 49, 10071 Borgaro, Torino Tel: ++ 39 11 451 0111

IR FAR EAST: K&H Bldg., 2F, 30-4 Nishi-Ikebukuro 3-Chome, Toshima-Ku, Tokyo Japan 171 Tel: 81 3 3983 0086

IR SOUTHEAST ASIA: 315 Outram Road, #10-02 Tan Boon Liat Building, Singapore 0316 Tel: 65 221 8371

<http://www.irf.com/>

Data and specifications subject to change without notice.

3/98