

HEXFET® Power MOSFET

**Applications**

- Synchronous Rectification
- Active ORing

$V_{DSS}$	$R_{DS(on) \max}$	$I_D$
30V	0.0028Ω	210A <sup>⑥</sup>

**Benefits**

- Ultra Low On-Resistance
- Low Gate Impedance to Reduce Switching Losses
- Fully Avalanche Rated



**Absolute Maximum Ratings**

	Parameter	Max.	Units
$I_D @ T_C = 25^\circ\text{C}$	Continuous Drain Current, $V_{GS} @ 10\text{V}$	210 <sup>⑥</sup>	A
$I_D @ T_C = 100^\circ\text{C}$	Continuous Drain Current, $V_{GS} @ 10\text{V}$	100 <sup>⑥</sup>	
$I_{DM}$	Pulsed Drain Current <sup>①</sup>	1000	
$P_D @ T_C = 25^\circ\text{C}$	Power Dissipation	230	W
$P_D @ T_A = 25^\circ\text{C}$	Power Dissipation	3.8	
	Linear Derating Factor	1.5	W/°C
$V_{GS}$	Gate-to-Source Voltage	± 20	V
dv/dt	Peak Diode Recovery dv/dt <sup>③</sup>	5.0	V/ns
$T_J, T_{STG}$	Junction and Storage Temperature Range	-55 to + 175	°C

**Thermal Resistance**

	Parameter	Typ.	Max.	Units
$R_{\theta JC}$	Junction-to-Case	—	0.65	°C/W
$R_{\theta CS}$	Case-to-Sink, Flat, Greased Surface	0.24	—	
$R_{\theta JA}$	Junction-to-Ambient	—	40	

**Typical SMPS Topologies**

- Forward and Bridge Converters with Synchronous Rectification for Telecom and Industrial Applications
- Offline High Power AC/DC Convertors using Synchronous Rectification

Notes <sup>①</sup> through <sup>⑥</sup> are on page 8

www.irf.com

# IRFP3703

International  
**IR** Rectifier

## Static @ $T_J = 25^\circ\text{C}$ (unless otherwise specified)

	Parameter	Min.	Typ.	Max.	Units	Conditions
$V_{(BR)DSS}$	Drain-to-Source Breakdown Voltage	30	—	—	V	$V_{GS} = 0V, I_D = 250\mu A$
$\Delta V_{(BR)DSS}/\Delta T_J$	Breakdown Voltage Temp. Coefficient	—	0.028	—	V/°C	Reference to $25^\circ\text{C}, I_D = 1\text{mA}$
$R_{DS(on)}$	Static Drain-to-Source On-Resistance	—	2.3	2.8	m $\Omega$	$V_{GS} = 10V, I_D = 76A$ ④
		—	2.8	3.9		$V_{GS} = 7.0V, I_D = 76A$ ④
$V_{GS(th)}$	Gate Threshold Voltage	2.0	—	4.0	V	$V_{DS} = V_{GS}, I_D = 250\mu A$
$I_{DSS}$	Drain-to-Source Leakage Current	—	—	20	$\mu A$	$V_{DS} = 24V, V_{GS} = 0V$
		—	—	250		$V_{DS} = 24V, V_{GS} = 0V, T_J = 150^\circ\text{C}$
$I_{GSS}$	Gate-to-Source Forward Leakage	—	—	200	nA	$V_{GS} = 20V$
	Gate-to-Source Reverse Leakage	—	—	-200		$V_{GS} = -20V$

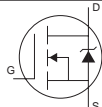
## Dynamic @ $T_J = 25^\circ\text{C}$ (unless otherwise specified)

	Parameter	Min.	Typ.	Max.	Units	Conditions
$g_{fs}$	Forward Transconductance	150	—	—	S	$V_{DS} = 24V, I_D = 76A$
$Q_g$	Total Gate Charge	—	209	—	nC	$I_D = 76A$
$Q_{gs}$	Gate-to-Source Charge	—	62	—		$V_{DS} = 24V$
$Q_{gd}$	Gate-to-Drain ("Miller") Charge	—	42	—		$V_{GS} = 10V$ , ④
$t_{d(on)}$	Turn-On Delay Time	—	18	—	ns	$V_{DD} = 15V, V_{GS} = 10V$
$t_r$	Rise Time	—	123	—		$I_D = 76A$
$t_{d(off)}$	Turn-Off Delay Time	—	53	—		$R_G = 1.8\Omega$
$t_f$	Fall Time	—	24	—		$V_{GS} = 10V$ ④
$C_{iss}$	Input Capacitance	—	8250	—	pF	$V_{GS} = 0V$
$C_{oss}$	Output Capacitance	—	3000	—		$V_{DS} = 25V$
$C_{riss}$	Reverse Transfer Capacitance	—	290	—		$f = 1.0\text{MHz}$
$C_{oss}$	Output Capacitance	—	10360	—		$V_{GS} = 0V, V_{DS} = 1.0V, f = 1.0\text{MHz}$
$C_{oss}$	Output Capacitance	—	3060	—		$V_{GS} = 0V, V_{DS} = 24V, f = 1.0\text{MHz}$
$C_{oss\ eff.}$	Effective Output Capacitance	—	2590	—		$V_{GS} = 0V, V_{DS} = 0V\ \text{to}\ 24V$ ⑤

## Avalanche Characteristics

	Parameter	Typ.	Max.	Units
$E_{AS}$	Single Pulse Avalanche Energy②	—	1700	mJ
$I_{AR}$	Avalanche Current①	—	76	A
$E_{AR}$	Repetitive Avalanche Energy①	—	23	mJ

## Diode Characteristics

	Parameter	Min.	Typ.	Max.	Units	Conditions
$I_S$	Continuous Source Current (Body Diode)	—	—	210⑥	A	MOSFET symbol showing the integral reverse p-n junction diode. 
$I_{SM}$	Pulsed Source Current (Body Diode) ①	—	—	1000		
$V_{SD}$	Diode Forward Voltage	—	0.8	1.3	V	$T_J = 25^\circ\text{C}, I_S = 76A, V_{GS} = 0V$ ④
$t_{rr}$	Reverse Recovery Time	—	80	120	ns	$T_J = 25^\circ\text{C}, I_F = 76A, V_{DS} = 16V$
$Q_{rr}$	Reverse Recovery Charge	—	185	275	nC	$di/dt = 100A/\mu s$ ④

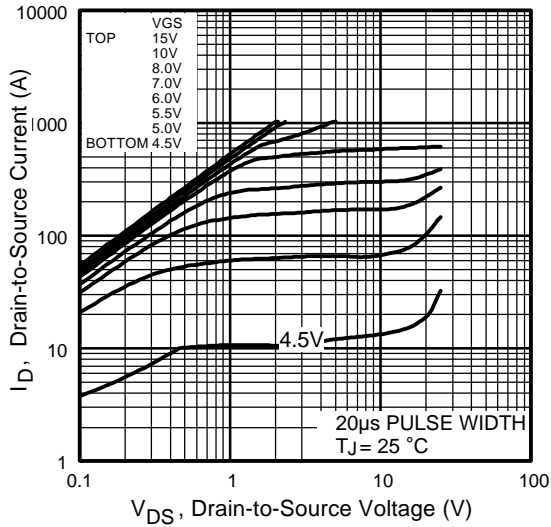


Fig 1. Typical Output Characteristics

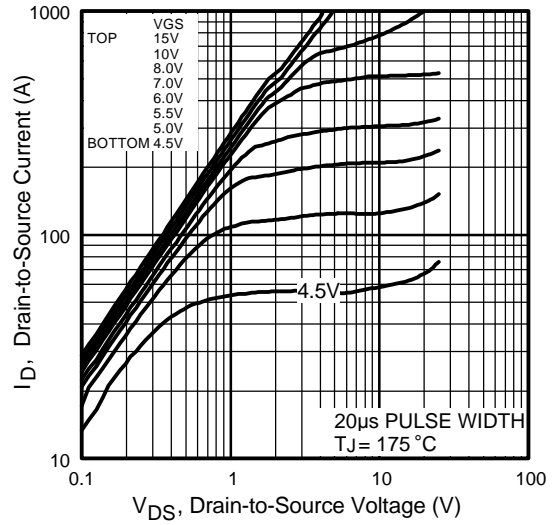


Fig 2. Typical Output Characteristics

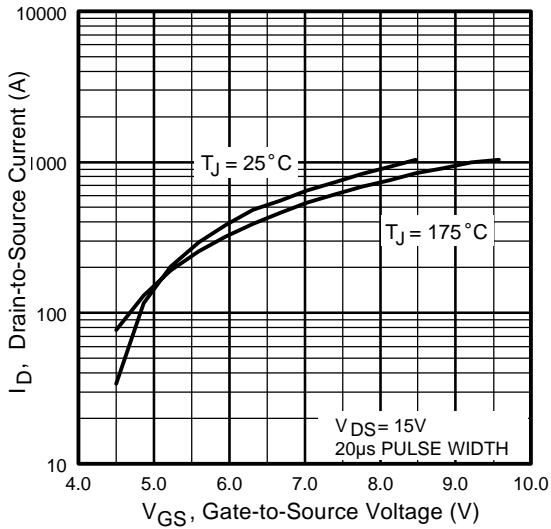


Fig 3. Typical Transfer Characteristics

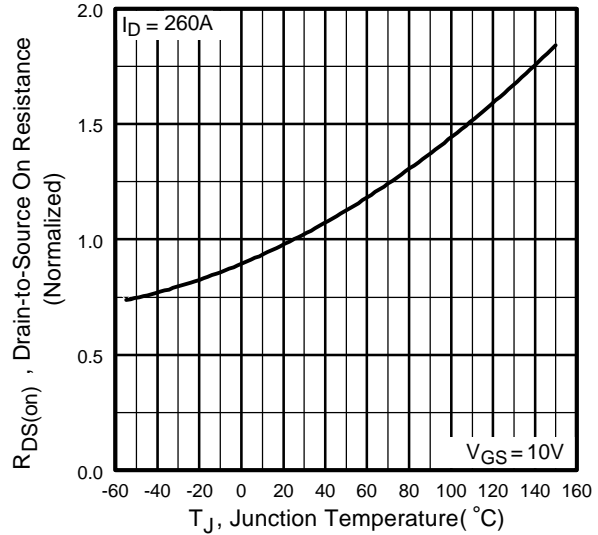
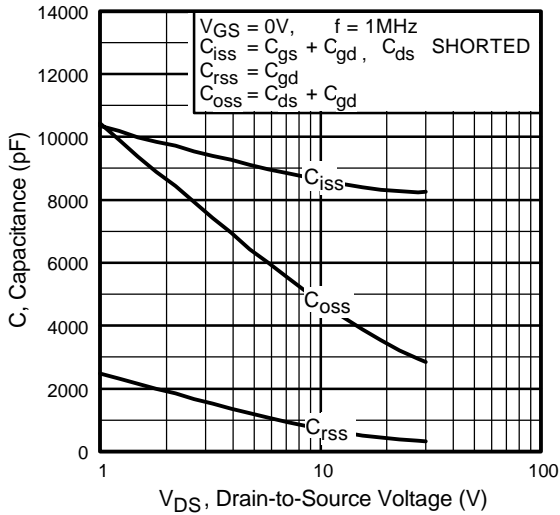
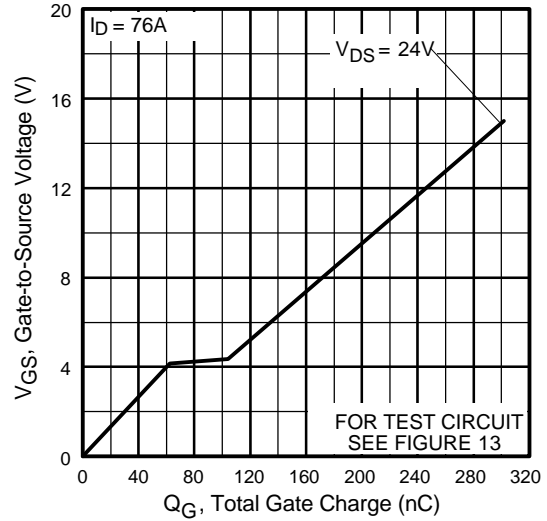


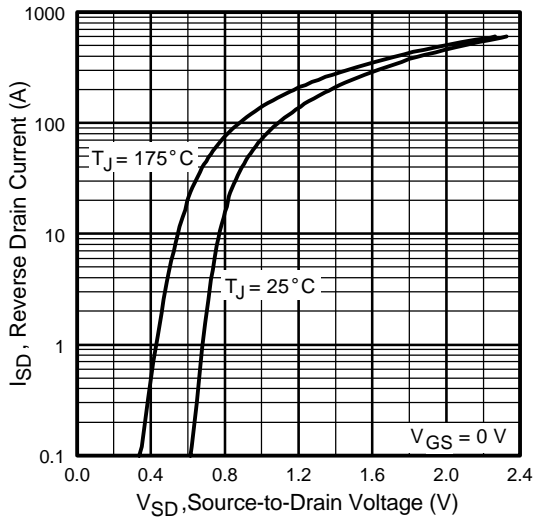
Fig 4. Normalized On-Resistance Vs. Temperature



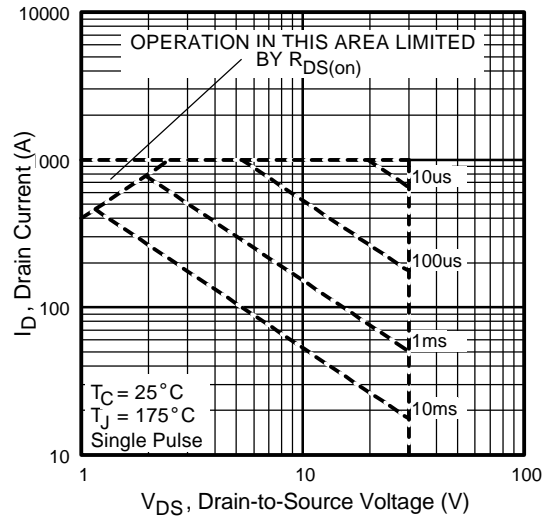
**Fig 5.** Typical Capacitance Vs. Drain-to-Source Voltage



**Fig 6.** Typical Gate Charge Vs. Gate-to-Source Voltage



**Fig 7.** Typical Source-Drain Diode Forward Voltage



**Fig 8.** Maximum Safe Operating Area

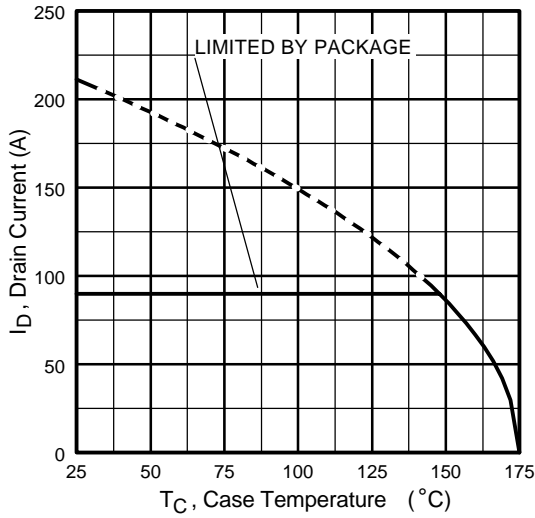


Fig 9. Maximum Drain Current Vs. Case Temperature



Fig 10a. Switching Time Test Circuit

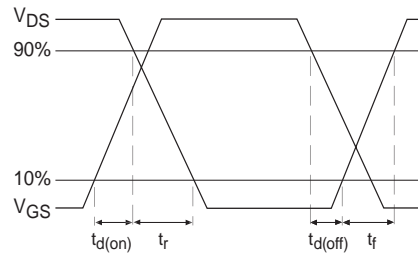


Fig 10b. Switching Time Waveforms

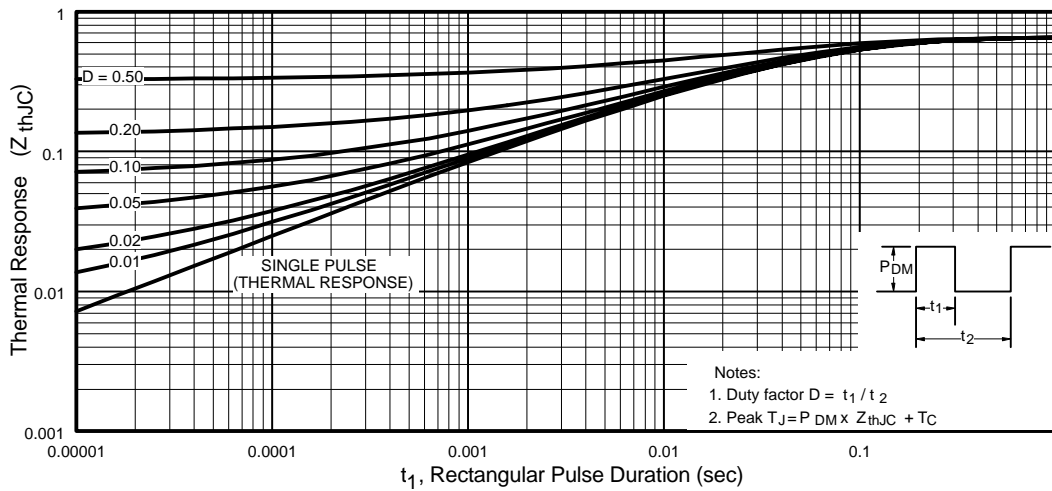
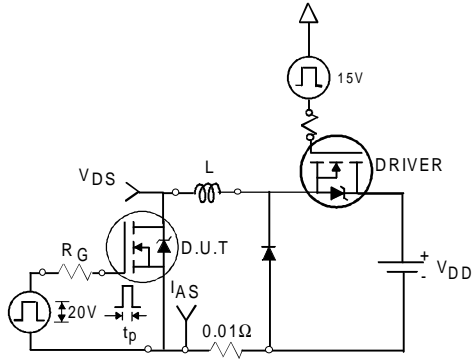


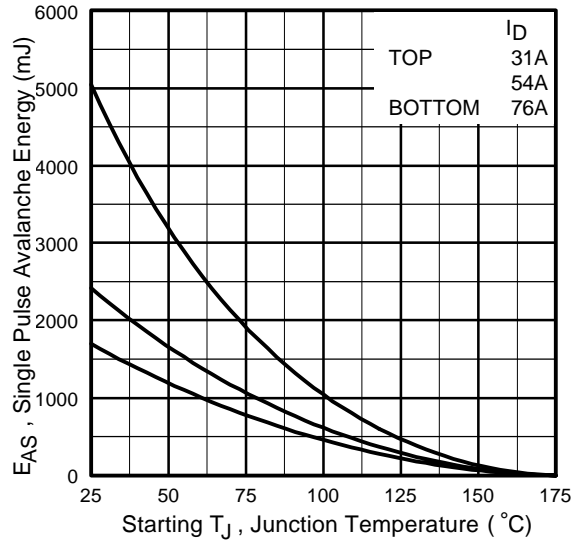
Fig 11. Maximum Effective Transient Thermal Impedance, Junction-to-Case

# IRFP3703

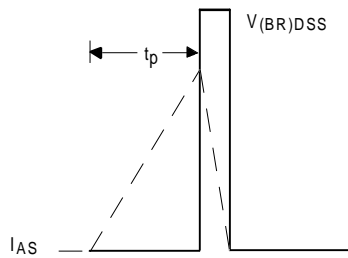
International  
**IR** Rectifier



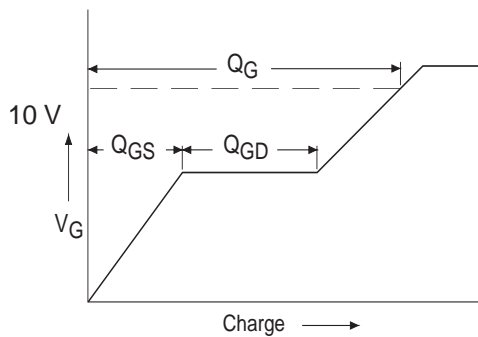
**Fig 12a.** Unclamped Inductive Test Circuit



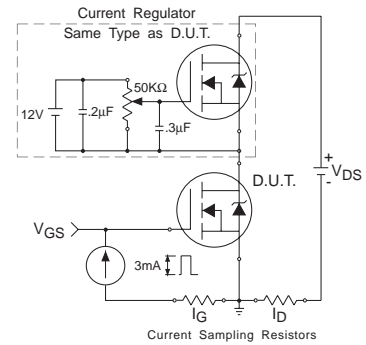
**Fig 12c.** Maximum Avalanche Energy Vs. Drain Current



**Fig 12b.** Unclamped Inductive Waveforms

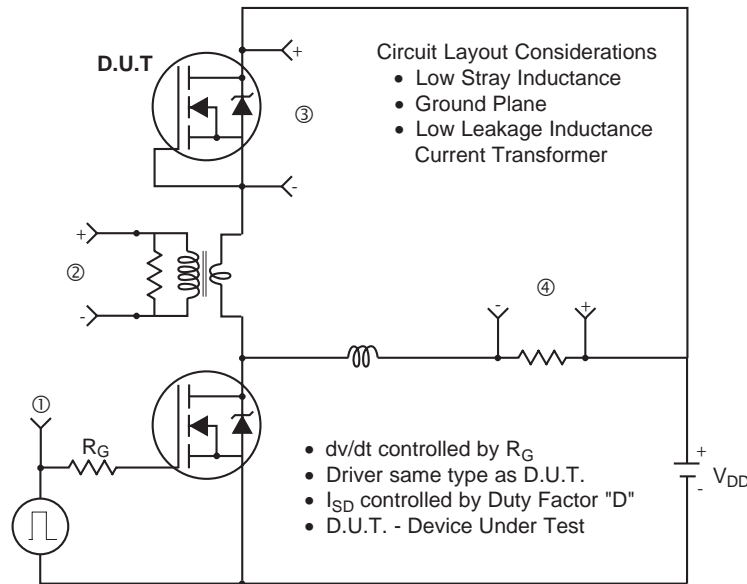


**Fig 13a.** Basic Gate Charge Waveform



**Fig 13b.** Gate Charge Test Circuit

**Peak Diode Recovery dv/dt Test Circuit**



\*  $V_{GS} = 5V$  for Logic Level Devices

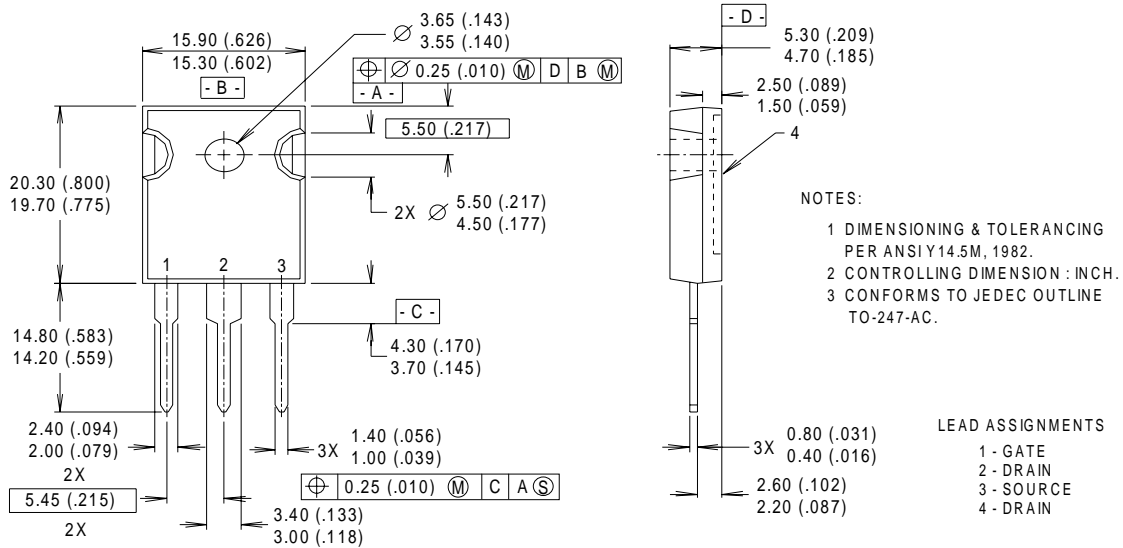
**Fig 14.** For N-Channel HEXFET® Power MOSFET

# IRFP3703

International  
**IR** Rectifier

## TO - 247 Package Outline

Dimensions are shown in millimeters (inches)



### Notes:

- ① Repetitive rating; pulse width limited by max. junction temperature.
- ② Starting  $T_J = 25^\circ\text{C}$ ,  $L = 0.6\text{mH}$   
 $R_G = 25\Omega$ ,  $I_{AS} = 76\text{A}$ .
- ③  $I_{SD} \leq 76\text{A}$ ,  $di/dt \leq 100\text{A}/\mu\text{s}$ ,  $V_{DD} \leq V_{(BR)DSS}$ ,  
 $T_J \leq 175^\circ\text{C}$
- ④ Pulse width  $\leq 300\mu\text{s}$ ; duty cycle  $\leq 2\%$ .
- ⑤  $C_{oss}$  eff. is a fixed capacitance that gives the same charging time as  $C_{oss}$  while  $V_{DS}$  is rising from 0 to 80%  $V_{DSS}$
- ⑥ Calculated continuous current based on maximum allowable junction temperature. Package limitation current is 90A

Data and specifications subject to change without notice.  
This product has been designed and qualified for the Industrial market.  
Qualification Standards can be found on IR's Web site.

International  
**IR** Rectifier

IR WORLD HEADQUARTERS: 233 Kansas St., El Segundo, California 90245, USA Tel: (310) 252-7105  
TAC Fax: (310) 252-7903

Visit us at [www.irf.com](http://www.irf.com) for sales contact information.5/01