

Major Ratings and Characteristics

| Characteristics | MBR190TR MBR1100TR | Units |
|---|-----------------------|------------------|
| $I_{F(AV)}$ Rectangular waveform | 1.0 | A |
| V_{RRM} | 90 - 100 | V |
| I_{FSM} @tp = 5 μ s sine | 870 | A |
| V_F @1.0 Apk, $T_J=125^\circ\text{C}$ | 0.63 | V |
| T_J range | -55 to 175 | $^\circ\text{C}$ |

Description/Features

The MBR190TR, MBR1100TR surface-mount Schottky rectifier has been designed for applications requiring low forward drop and very small foot prints on PC boards. Typical applications are in disk drives, switching power supplies, converters, free-wheeling diodes, battery charging, and reverse battery protection.

- Small foot print, surface mountable
- Low forward voltage drop
- High frequency operation
- Guard ring for enhanced ruggedness and long term reliability

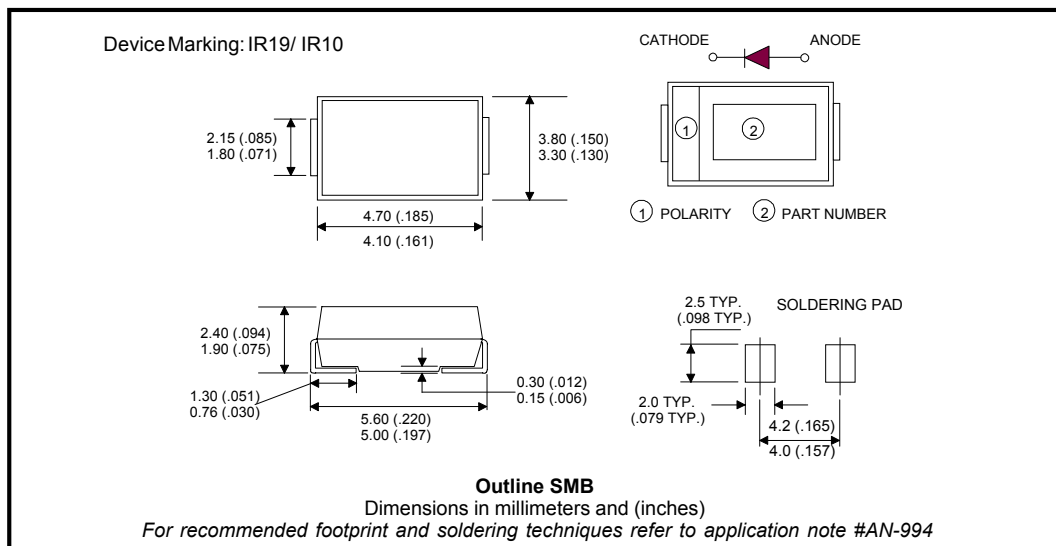

Voltage Ratings

| Part number | MBRS190TR | MBRS1100TR |
|--|-----------|------------|
| V _R Max. DC Reverse Voltage (V) | 90 | 100 |
| V _{RWM} Max. Working Peak Reverse Voltage (V) | | |

Absolute Maximum Ratings

| Parameters | Value | Units | Conditions |
|---|-------|-------|--|
| I _{F(AV)} Max. Average Forward Current | 1.0 | A | 50% duty cycle @ T _L = 147 °C, rectangular wave form |
| I _{FSM} Max. Peak One Cycle Non-Repetitive Surge Current | 870 | A | Following any rated load condition and with rated V _{RRM} applied |
| | 50 | | |
| E _{AS} Non-Repetitive Avalanche Energy | 5.0 | mJ | T _J = 25 °C, I _{AS} = 0.5A, L = 10mH |
| I _{AR} Repetitive Avalanche Current | 0.2 | A | |

Electrical Specifications

| Parameters | Value | Units | Conditions | |
|--|-------|-------|---|---------------------------------------|
| V _{FM} Max. Forward Voltage Drop (1) * See Fig. 1 | 0.78 | V | @ 1A | T _J = 25 °C |
| | 0.62 | V | @ 1A | T _J = 125 °C |
| I _{RM} Max. Reverse Leakage Current (1) * See Fig. 2 | 0.5 | mA | T _J = 25 °C | V _R = rated V _R |
| | 1.0 | mA | T _J = 125 °C | |
| C _T Typical Junction Capacitance | 42 | pF | V _R = 5V _{DC} , (test signal range 100kHz to 1MHz) 25°C | |
| L _S Typical Series Inductance | 2.0 | nH | Measured lead to lead 5mm from package body | |
| dv/dt Max. Volatge Rate of Charge (Rated V _R) | 10000 | V/ µs | | |

(1) Pulse Width < 300µs, Duty Cycle < 2%

Thermal-Mechanical Specifications

| Parameters | Value | Units | Conditions |
|---|-------------|---------|---------------------------|
| T _J Max. Junction Temperature Range (*) | -55 to 175 | °C | |
| T _{stg} Max. Storage Temperature Range | -55 to 175 | °C | |
| R _{thJL} Max. Thermal Resistance Junction to Lead (**) | 36 | °C/W | DC operation (See Fig. 4) |
| R _{thJA} Max. Thermal Resistance Junction to Ambient | 80 | °C/W | DC operation |
| wt Approximate Weight | 0.10(0.003) | g (oz.) | |
| Case Style | SMB | | Similar to DO-214AA |
| Device Marking | IR19-IR10 | | |

(*) $\frac{dP_{tot}}{dT_J} < \frac{1}{R_{th(j-a)}}$ thermal runaway condition for a diode on its own heatsink

(**) Mounted 1 inch square PCB

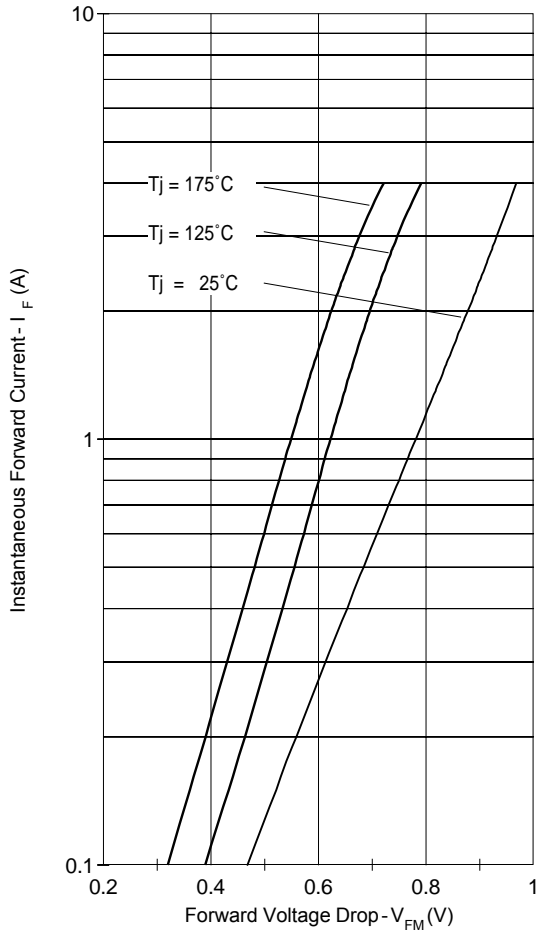

Fig. 1 - Maximum Forward Voltage Drop Characteristics

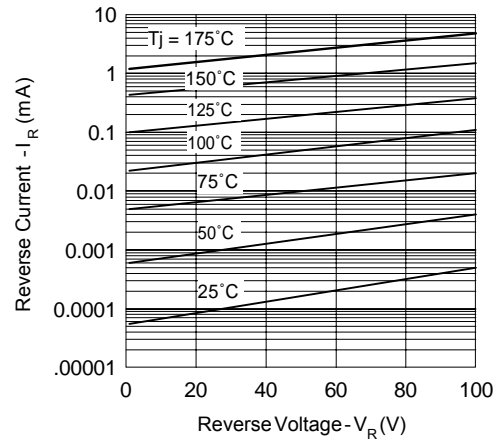

Fig. 2 - Typical Peak Reverse Current Vs. Reverse Voltage

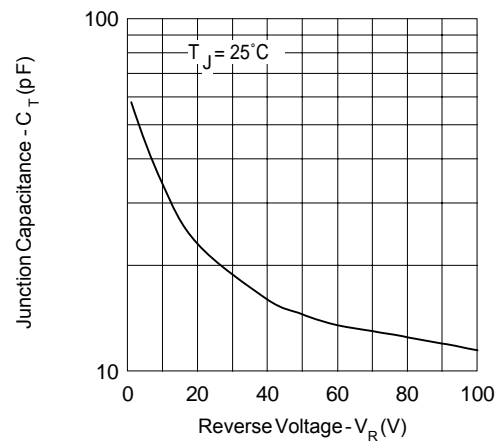

Fig. 3 - Typical Junction Capacitance Vs. Reverse Voltage

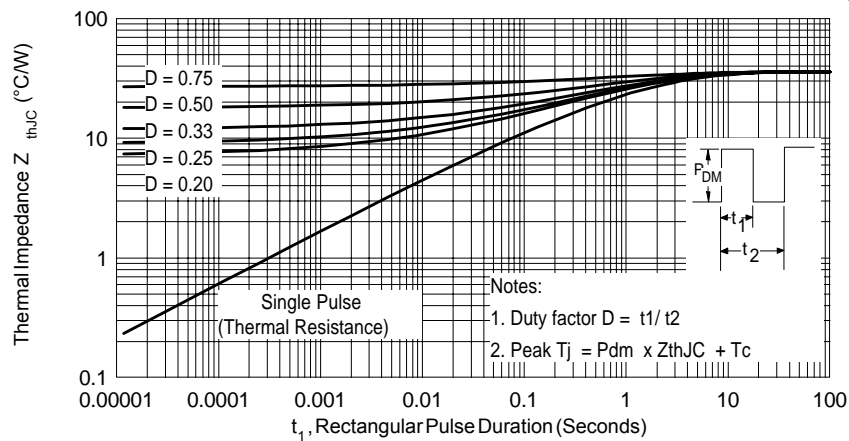

Fig. 4 - Max. Thermal Impedance Z_{thJC} Characteristics (Per Leg)

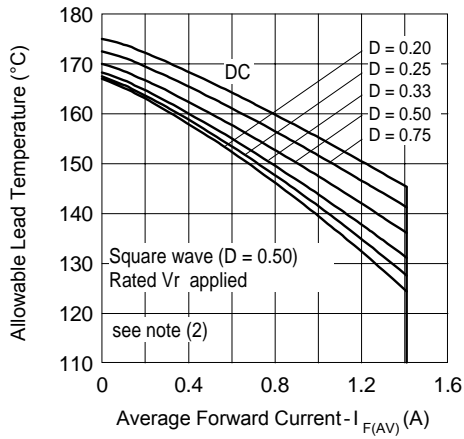

Fig. 4 - Maximum Average Forward Current Vs. Allowable Lead Temperature

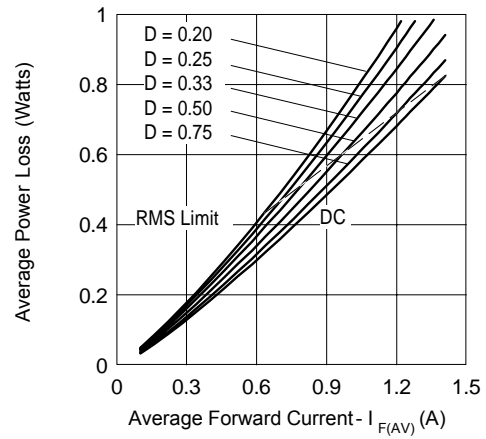

Fig. 5 - Maximum Average Forward Dissipation Vs. Average Forward Current

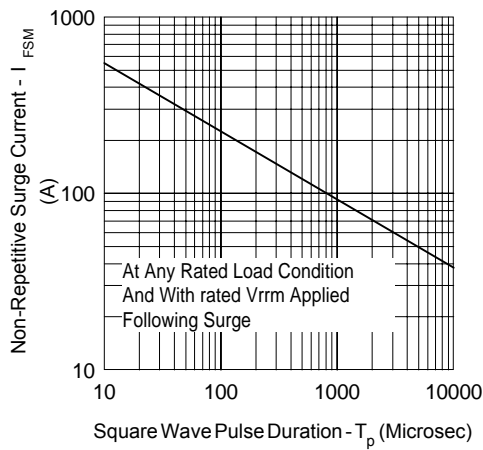

Fig. 6 - Maximum Peak Surge Forward Current Vs. Pulse Duration

(2) Formula used: $T_C = T_J - (Pd + Pd_{REV}) \times R_{thJC}$;

Pd = Forward Power Loss = $I_{F(AV)} \times V_{FM} @ (I_{F(AV)} / D)$ (see Fig. 6);

Pd_{REV} = Inverse Power Loss = $V_{R1} \times I_R (1 - D)$; $I_R @ V_{R1} = 80\%$ rated V_R

Tape & Reel Information

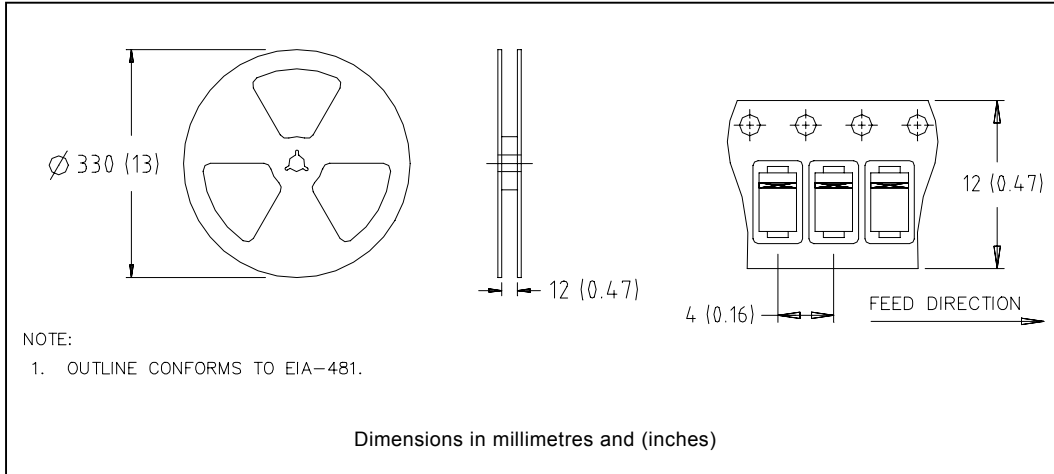

Marking & Identification

Ordering Information

Each device has 2 rows for identification. The first row designates the device as manufactured by International Rectifier as indicated by the letters "IR", and the Part Number (indicates the current and the voltage rating). The second row indicates the year, the week of manufacturing and the Site ID.

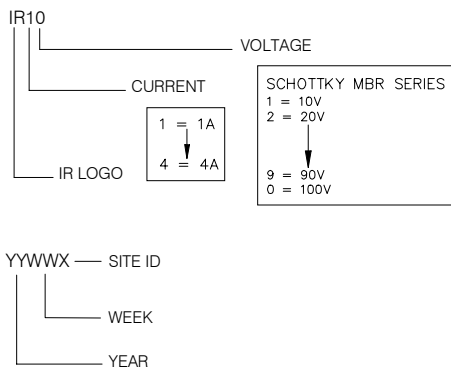
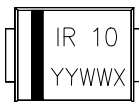

MBRS1100TR - TAPE AND REEL

WHEN ORDERING, INDICATE THE PART NUMBER AND THE QUANTITY (IN MULTIPLES OF 3000 PIECES).

EXAMPLE: MBRS1100TR - 6000 PIECES

MBRS190TR, MBRS1100TR

Bulletin PD-20592 rev. C 05/02

International
IOR Rectifier

Data and specifications subject to change without notice.
This product has been designed and qualified for Industrial Level.
Qualification Standards can be found on IR's Web site.

International
IOR Rectifier

IR WORLD HEADQUARTERS: 233 Kansas St., El Segundo, California 90245, USA Tel: (310) 252-7105
TAC Fax: (310) 252-7309
Visit us at www.irf.com for sales contact information. 05/02