

# IC for Headphone Stereos Monolithic IC LAG673

## Outline

This IC was developed for use in 3 V headphone stereos. It incorporates dual preamp, power amp, electronic volume and motor control circuits; because it requires extremely few external components, it can be used in a simple circuit configuration.

## Features

1. Broad operating voltage range of 2.0 to 5.0 V
2. Few external components required
3. Well-balanced electronic VR, A-curve attenuation characteristic obtained with B-curve VR
4. Internal motor control circuit, with noise from motor driving unit suppressed
5. Fast forward possible using the forced-on pin

## Package

SOP-28B (LAG673F)

SDIP-30A (LAG673D)

## Absolute Maximum Ratings

Item	Symbol	Ratings	Units
Operating temperature	T <sub>OPR</sub>	-20~+65	°C
Storage temperature	T <sub>STG</sub>	-40~+125	°C
Power supply current	V <sub>CC</sub>	-0.3~+7.5	V
Operating voltage	V <sub>OP</sub>	2.0~5.0	V
Power consumption	P <sub>d</sub>	450 (SOP-28B) 750 (SDIP-30A)	mW

**Electrical Characteristics** (Except where noted otherwise, Ta=25°C)

Item	Symbol	Measurement conditions	Min.	Typ.	Max.	Units
Consumption current (excluding motor speed controller unit)	I <sub>cc</sub>	V <sub>IN</sub> =0V, I <sub>M</sub> =0mA		18	25	mA
<b>Preamp unit (Ta=25°C)</b>						
Open-circuit gain	G <sub>vo</sub>	V <sub>o</sub> =-10dBm, R <sub>L</sub> =∞		72		dB
Closed-circuit gain	G <sub>vc</sub>	V <sub>o</sub> =-10dBm	40	42	44	dB
Maximum output voltage	V <sub>om</sub>	THD=10%	0.30	0.45		V <sub>rms</sub>
Total harmonic distortion ratio	THD	V <sub>OUT</sub> =400mV <sub>rms</sub>		0.05	0.5	%
Output noise voltage	V <sub>no</sub>	V <sub>IN</sub> =0V, R <sub>g</sub> =2.2kΩ, BPF=30Hz~20kHz		150	300	μV <sub>rms</sub>
Input impedance	Z <sub>in</sub>	V <sub>OUT</sub> =-10dBm	18	22		kΩ
Crosstalk between channels	C · T	R <sub>g</sub> =2.2kΩ, V <sub>OUT</sub> =-10dBm	30			dB
Output voltage with preamp off	V <sub>ooff</sub>	V <sub>IN</sub> =100mV <sub>rms</sub>			-50	dB
Output resistance with preamp off	R <sub>ooff</sub>			10		kΩ
Input resistance with preamp off	R <sub>ioff</sub>			10		kΩ
<b>Attenuator unit (Ta=25°C)</b>						
Maximum input voltage	V <sub>i max.</sub>		0.2			V <sub>rms</sub>
Maximum attenuation	V <sub>a max.</sub>	V <sub>cont</sub> =min.	66			dB
Attenuation error	V <sub>aerr</sub>	V <sub>cont</sub> =max.		0		dB
Input impedance	Z <sub>ia</sub>		15	20		kΩ
Control pin input resistance	Z <sub>icot</sub>			100		kΩ
<b>Power amp unit (Ta=25°C)</b>						
Voltage gain	G <sub>v</sub>	P <sub>OUT</sub> =5mW	26	28	30	dB
Voltage gain difference between channels	ΔG <sub>v</sub>	V <sub>cont</sub> =max.		0	3	dB
Maximum output power I	P <sub>om</sub>	THD=10%, R <sub>L</sub> =32Ω	20	28		mW
Maximum output power II	P <sub>om</sub>	THD=10%, R <sub>L</sub> =16Ω	30			mW
Total harmonic distortion ratio	THD	P <sub>OUT</sub> =5mW		0.2	2.0	%
Crosstalk between channels	C · T	P <sub>OUT</sub> =5mW	45	55		dB
Output noise voltage	V <sub>n</sub>	R <sub>g</sub> =2.2kΩ, V <sub>cont</sub> =min.		0.25	1.0	mV <sub>rms</sub>
Ripple rejection	RR	100Hz, 100mV <sub>p-p</sub>	42	50		dB
Noise of preamp + power amp	V <sub>nto</sub>	V <sub>IN</sub> =0V, R <sub>g</sub> =2.2kΩ, V <sub>cont</sub> =max.		6	9	mV <sub>rms</sub>
<b>Motor control unit (Ta=25°C)</b>						
Consumption current	I <sub>MC</sub>			3.0	5.0	mA
Startup current	I <sub>MS</sub>		500			mA
Reference voltage	V <sub>ref</sub>	Between R <sub>ML</sub> -ADJ pins	0.72	0.80	0.87	V
Reference voltage fluctuation I	ΔV <sub>ref1</sub>	V <sub>CC</sub> between 2.0 and 5.0V *		0.05		%/V
Reference voltage fluctuation II	ΔV <sub>ref2</sub>	I <sub>M</sub> between 25 and 250 mA		0.01		%/mA
Reference voltage fluctuation III	ΔV <sub>ref3</sub>	T <sub>a</sub> between -10 and 50°C		0.01		%/°C
Current coefficient	ΔK	$K = \frac{\Delta V_{RL}}{R_L \Delta I_M}$	32	38	43	
Current coefficient fluctuation I	ΔK1	V <sub>CC</sub> between 2.0 and 6.5 V		0.5		%/V
Current coefficient fluctuation II	ΔK2	I <sub>M</sub> between 25 and 250 mA		0.05		%/mA
Current coefficient fluctuation III	ΔK3	T <sub>a</sub> between -10 and 60°C		0.02		%/°C
Output voltage on forced on	V <sub>CEsa</sub>	T <sub>M</sub> =200mA			0.6	V
Input resistance on forced on	R <sub>ion</sub>			5.6		kΩ
Leakage current on forced off	I <sub>ML</sub>				200	μA
Input resistance on forced off	R <sub>icon</sub>			33		kΩ

Conditions: V<sub>CC</sub>=3.0 V, I<sub>M</sub> = 100 mA Motor: M25E-7 (Mitsumi model)

\*Voltage drift between pins 17 and 13

Block Diagram

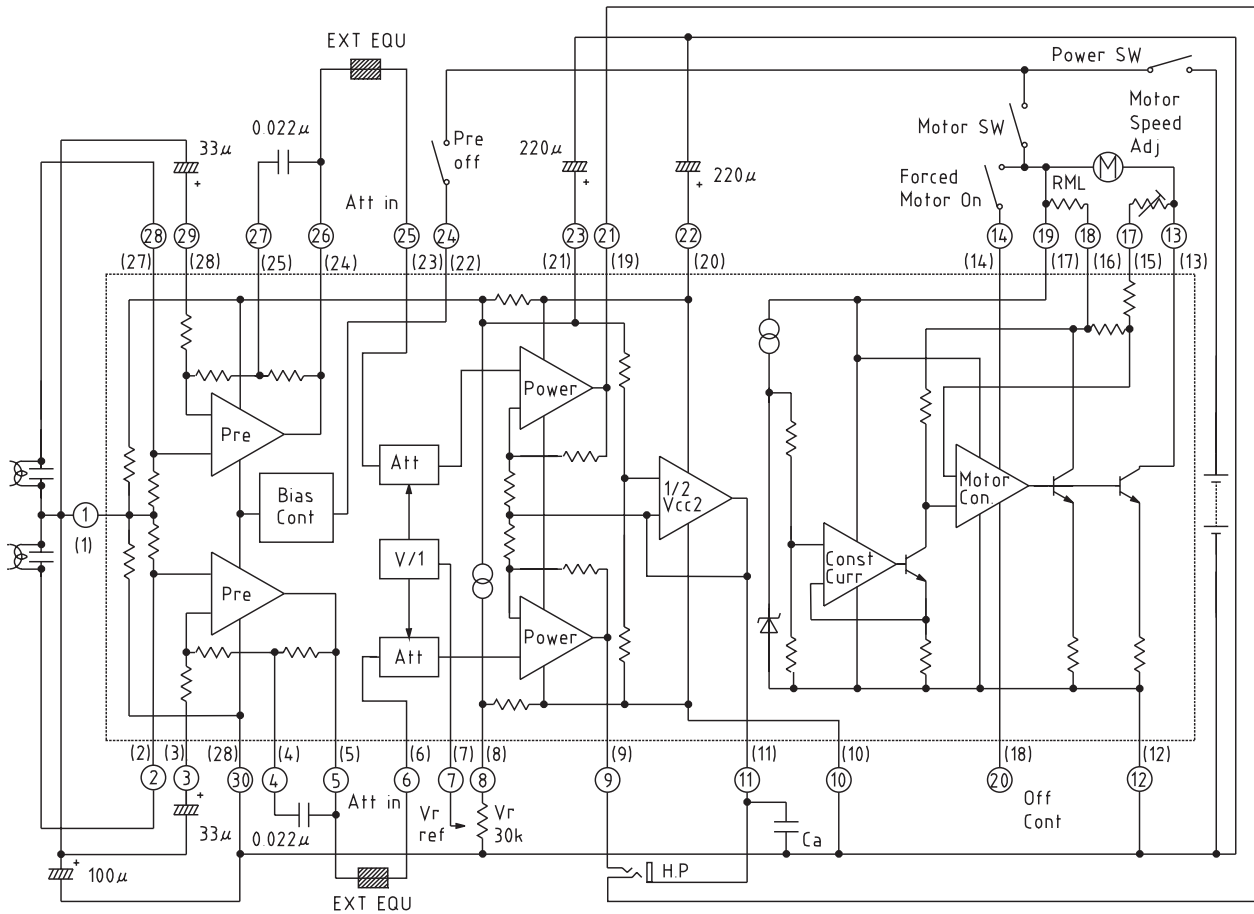

- 1: The motor speed potentiometer is 1.5 kΩ (assuming the motor used is Mitsumi M25E-7; if the optimal adjustment range is not obtained using a different motor, add a fixed resistance).
- 2: RML = motor load correction resistance
- 3: Connecting the preamp off pin to +V<sub>CC</sub> turns the preamp circuits off.
- 4: Connecting the motor forced-on pin to +V<sub>CC</sub> turns the motor on (no control).
- 5: in circles are pin numbers for a DIP-30P package; numbers in parentheses ( ) are for an SOP-28B package.
- 6: In the DIP-30P package, pins 15 and 16 are NC.
- 7: C<sub>a</sub> is a 100,000 pF capacitor used to prevent oscillation of the 1/2 V<sub>CC</sub> amp circuit.

Characteristics

Preamp

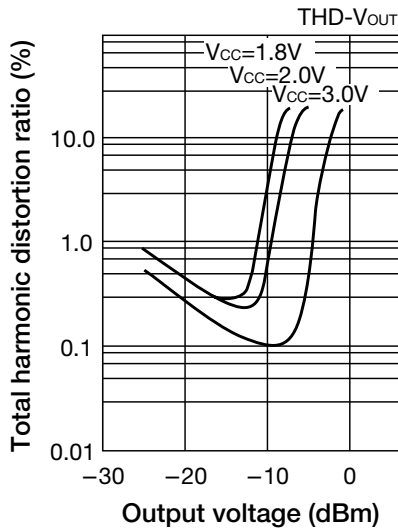

Attenuator

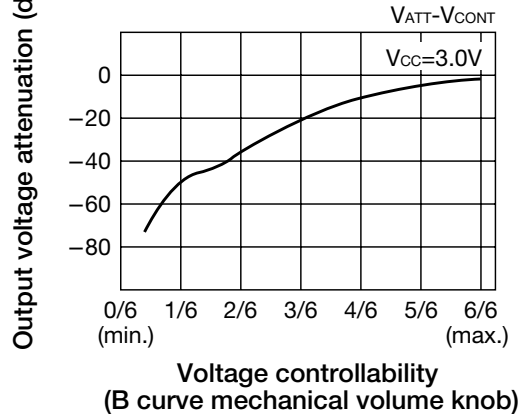

P<sub>OUT.</sub>

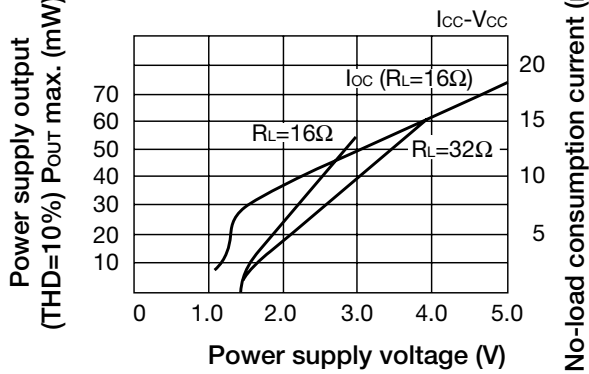

Power amp

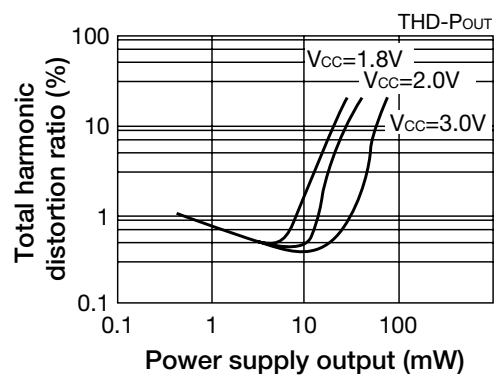

Power amp

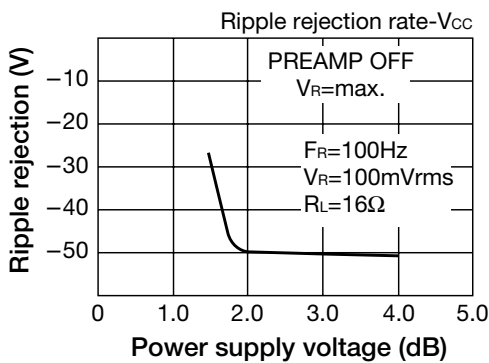

Power amp

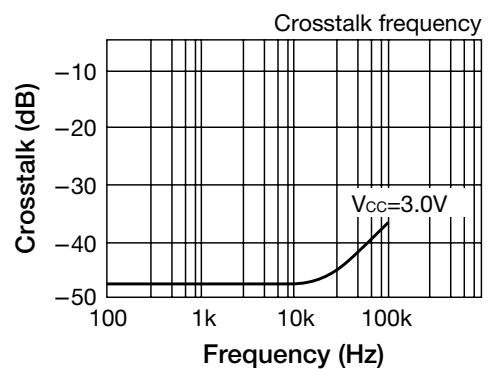

Voltage gain vs. Frequency

