

LM2797/LM2798 120mA High Efficiency Step-Down Switched Capacitor Voltage Converter with Voltage Monitoring

General Description

The LM2797/98 switched capacitor step-down DC/DC converters efficiently produce a 120mA regulated low-voltage rail from a 2.6V to 5.5V input. Fixed output voltage options of 1.5V, 1.8V, and 2.0V are available. The LM2797/98 uses multiple fractional gain configurations to maximize conversion efficiency over the entire input voltage and output current ranges. Also contributing to high overall efficiency is the extremely low supply current of the LM2797/98: 35µA operating unloaded and 0.1µA in shutdown.

Features of the LM2797/98 include input voltage and output voltage monitoring. Pin BATOK provides battery monitoring by indicating when the input voltage is above 2.85V (typ.). Pin POK verifies that the output voltage is not more than 5% (typ.) below the nominal output voltage of the part.

The optimal external component requirements of the LM2797/98 solution minimize size and cost, making the part ideal for Li-Ion and other battery powered designs. Two 1µF flying capacitors and two 10µF bypass capacitors are all that is required, and no inductors are needed.

The LM2797/98 also features short-circuit protection over-temperature protection, and soft-start circuitry to prevent excessive inrush currents. The LM2798 has a 400µs turn-on time. The turn-on time of the LM2797 is 100µs.

Features

- Output voltage options:
2.0V ± 5%, 1.8V ± 5%, and 1.5V ± 6%
- 120mA output current capability
- Multi-Gain and Gain Hopping for Highest Possible Efficiency - up to 90% Efficient
- 2.6V to 5.5V input range
- Input and Output Voltage Monitoring (BATOK and POK)
- Low operating supply current: 35µA
- Shutdown supply current: 0.1µA
- Thermal and short circuit protection
- LM2798 turn-on time: 400µs
LM2797 turn-on time: 100µs
- Available in an 10-Pin MSOP Package

Applications

- Cellular Phones
- Pagers
- H/PC and P/PC Devices
- Portable Electronic Equipment
- Handheld Instrumentation

Typical Application Circuit

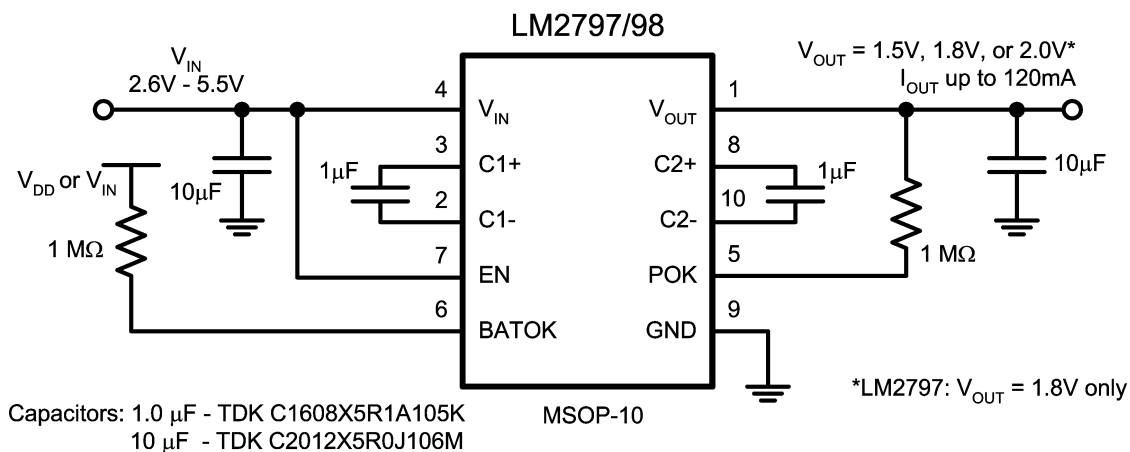

20044501

Connection Diagram

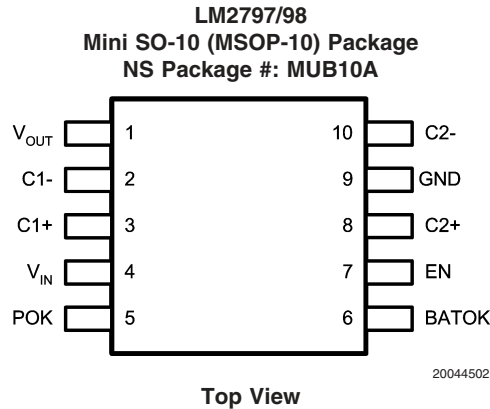

Pin Description

Pin	Name	Description
1	V _{OUT}	Regulated Output Voltage
2	C1-	First Flying Capacitor: Negative Terminal
3	C1+	First Flying Capacitor: Positive terminal
4	V _{IN}	Input Voltage. Recommended V _{IN} Range: 2.6V to 5.5V
5	POK	Power-OK Indicator: Output voltage sense. Open-drain NFET output. With an external pull-up resistor tied to POK, V(POK) will be high when V _{OUT} is regulating correctly. When V _{OUT} falls out of regulation, the internal open-drain FET pulls the POK voltage low.
6	BATOK	Battery-OK Indicator: Input voltage sense. Open-drain NFET output. With an external pull-up resistor tied to BATOK, V(BATOK) will be high when V _{IN} > 2.85V (typ). LM2797/98 pulls V(BATOK) low when V _{IN} < 2.65V (typ.) , and/or when the part is in shutdown [V(EN) = 0].
7	EN	Enable Logic Input. High voltage = ON, Low voltage = SHUTDOWN
8	C2+	Second Flying Capacitor: Positive Terminal
9	GND	Ground Connection
10	C2-	Second Flying Capacitor: Negative Terminal

Ordering Information

Nominal Output Voltage V _{OUT(NOM)}	Turn-on Time	Order Number	Package Marking	Supplied As:
1.80V	100µs	LM2797MM-1.8	S80B	1000 units on Tape-and Reel
		LM2797MMX-1.8		3500 units on Tape-and-Reel
1.50V	400µs	LM2798MM-1.5	S56B	1000 units on Tape-and Reel
		LM2798MMX-1.5		3500 units on Tape-and-Reel
1.80V	400µs	LM2798MM-1.8	S57B	1000 units on Tape-and Reel
		LM2798MMX-1.8		3500 units on Tape-and-Reel
2.00V	400µs	LM2798MM-2.0	S58B	1000 units on Tape-and Reel
		LM2798MMX-2.0		3500 units on Tape-and-Reel

Absolute Maximum Ratings (Notes 1,

2)

If Military/Aerospace specified devices are required, please contact the National Semiconductor Sales Office/Distributors for availability and specifications.

V_{IN} , EN, POK, BATOK pins: Voltage to Ground (Note 3)	-0.3V to 5.6V
Junction Temperature ($T_{J-MAX-ABS}$)	150°C
Continuous Power Dissipation (Note 4)	Internally Limited
V_{OUT} Short-Circuit to GND Duration (Note 4)	Unlimited
Storage Temperature Range	-65°C to 150°C
Lead Temperature (Soldering, 5 Sec.)	260°C
ESD Rating (Note 5)	
Human-body model:	2 kV
Machine model	200V

Operating Ratings (Notes 1, 2)

Input Voltage Range	2.6V to 5.5V
Recommended Output Current Range	0mA to 120mA
Junction Temperature Range	-40°C to 125°C
Ambient Temperature Range (Note 6)	-40°C to 85°C

Thermal Information

Thermal Resistance, MSOP-8	220°C/W
Resistance, MSOP-8 Package (θ_{JA}) (Note 7)	

Electrical Characteristics (Notes 2, 8)

Limits in standard typeface and typical values apply for $T_J = 25^\circ\text{C}$. Limits in **boldface** type apply over the operating junction temperature range. Unless otherwise specified: $2.6 \leq V_{IN} \leq 5.5\text{V}$, $V(EN) = V_{IN}$, $C_1 = C_2 = 1\mu\text{F}$, $C_{IN} = C_{OUT} = 10\mu\text{F}$. (Note 9)

Symbol	Parameter	Conditions	Min	Typ	Max	Units
LM2797-1.8, LM2798-1.8, LM2798-2.0						
V_{OUT}	Output Voltage Tolerance	$2.8\text{V} \leq V_{IN} \leq 4.2\text{V}$ $0\text{mA} \leq I_{OUT} \leq 120\text{mA}$	-5		+5	% of $V_{OUT(nom)}$ (Note 10)
		$4.2\text{V} < V_{IN} \leq 5.5\text{V}$ $0\text{mA} \leq I_{OUT} \leq 120\text{mA}$	-6		+6	
LM2798-1.5						
V_{OUT}	Output Voltage Tolerance	$2.8\text{V} \leq V_{IN} \leq 4.2\text{V}$ $0\text{mA} \leq I_{OUT} \leq 120\text{mA}$	-6		+6	% of $V_{OUT(nom)}$ (Note 10)
		$4.2\text{V} < V_{IN} \leq 5.5\text{V}$ $0\text{mA} \leq I_{OUT} \leq 120\text{mA}$	-6		+6	
All Output Voltage Options						
I_Q	Operating Supply Current	$I_{OUT} = 0\text{mA}$		35	50	μA
I_{SD}	Shutdown Supply Current	$V(EN) = 0\text{V}$		0.1	2	μA
V_R	Output Voltage Ripple	LM2798-1.8: $V_{IN} = 3.6\text{V}$, $I_{OUT} = 120\text{mA}$		20		mV_{p-p}
E_{PEAK}	Peak Efficiency	LM2798-1.8: $V_{IN} = 3.0\text{V}$, $I_{OUT} = 60\text{mA}$		90		%
E_{AVG}	Average Efficiency over Li-Ion Input Voltage Range (Note 11)	LM2798-1.5: $3.0 \leq V_{IN} \leq 4.2\text{V}$, $I_{OUT} = 60\text{mA}$		76		%
		LM2798-1.8: $3.0 \leq V_{IN} \leq 4.2\text{V}$, $I_{OUT} = 60\text{mA}$		82		
		LM2798-2.0: $3.0 \leq V_{IN} \leq 4.2\text{V}$, $I_{OUT} = 60\text{mA}$		75		
t_{ON}	Turn-On Time	LM2798, $V_{IN}=2.6\text{V}$, $I_{OUT}=100\text{mA}$, (Note 12)		400		μs
		LM2797, $V_{IN}=2.6\text{V}$, $I_{OUT}=100\text{mA}$, (Note 12)		100		
f_{SW}	Switching Frequency			500		kHz
I_{SC}	Short-Circuit Current	$V_{IN} = 3.6$, $V_{OUT} = 0\text{V}$		25		mA
Enable Pin (EN) Characteristics						
V_{IH}	EN pin Logic-High Input		0.9		V_{IN}	V
V_{IL}	EN pin Logic-Low Input		0		0.4	V
I_{EN}	EN pin input current	$V_{EN} = 0\text{V}$		0		nA
		$V_{EN} = 5.5\text{V}$		30		

Electrical Characteristics (Notes 2, 8) (Continued)

Limits in standard typeface and typical values apply for $T_J = 25^\circ\text{C}$. Limits in **boldface** type apply over the operating junction temperature range. Unless otherwise specified: $2.6 \leq V_{IN} \leq 5.5\text{V}$, $V(\text{EN}) = V_{IN}$, $C_1 = C_2 = 1\mu\text{F}$, $C_{IN} = C_{OUT} = 10\mu\text{F}$. (Note 9)

Symbol	Parameter	Conditions	Min	Typ	Max	Units
POK Characteristics						
$V_{T\text{-POK}}$	Threshold of output voltage for POK transition	POK transition L to H		95	99	% of $V_{\text{OUT-NOM}}$ (Note 10)
		POK transition H to L	83	92		
		Hysteresis		3		
$I_{\text{POK-H}}$	POK-high leakage current	$V(\text{POK}) = 3.6\text{V}$		1	5	μA
$V_{\text{POK-L}}$	POL-low pull-down voltage	$I(\text{POK}) = -100\mu\text{A}$		200	300	mV
BATOK Characteristics						
$V_{T\text{-BATOK}}$	Input voltage threshold for BATOK transition	BATOK transition L to H		2.85	3.0	V
		BATOK transition H to L	2.4	2.65		
		Hysteresis		0.20		
$I_{\text{BATOK-H}}$	BATOK-high leakage current	$V(\text{BATOK}) = 3.6\text{V}$		1	5	μA
$V_{\text{BATOK-L}}$	BATOK-low pull-down voltage	$I(\text{BATOK}) = -100\mu\text{A}$		200	300	mV

Note 1: Absolute Maximum Ratings indicate limits beyond which damage to the component may occur. Operating Ratings are conditions under which operation of the device is guaranteed. Operating Ratings do not imply guaranteed performance limits. For guaranteed performance limits and associated test conditions, see the Electrical Characteristics tables.

Note 2: All voltages are with respect to the potential at the GND pin.

Note 3: Voltage on the EN pin must not be brought above $V_{IN} + 0.3\text{V}$.

Note 4: Thermal shutdown circuitry protects the device from permanent damage.

Note 5: The human-body model is a 100 pF capacitor discharged through a 1.5k Ω resistor into each pin. The machine model is a 200pF capacitor discharged directly into each pin.

Note 6: Maximum ambient temperature ($T_{A\text{-MAX}}$) is dependent on the maximum operating junction temperature ($T_{J\text{-MAX-OP}} = 125^\circ\text{C}$), the maximum power dissipation of the device in the application ($P_{D\text{-MAX}}$), and the junction-to ambient thermal resistance of the part/package in the application (θ_{JA}), as given by the following equation: $T_{A\text{-MAX}} = T_{J\text{-MAX-OP}} - (\theta_{JA} \times P_{D\text{-MAX}})$. The ambient temperature operating rating is provided merely for convenience. This part may be operated outside the listed T_A rating so long as the junction temperature of the device does not exceed the maximum operating rating of 125°C .

Note 7: Junction-to-ambient thermal resistance is highly dependent on application conditions and PC board layout. In applications where high maximum power dissipation exists, special care must be paid to thermal dissipation issues. For more information on these topics, please refer to the **Power Dissipation** section of this datasheet.

Note 8: All room temperature limits are 100% tested or guaranteed through statistical analysis. All limits at temperature extremes are guaranteed by correlation using standard Statistical Quality Control methods (SQC). All limits are used to calculate Average Outgoing Quality Level (AOQL). Typical numbers are not guaranteed, but do represent the most likely norm.

Note 9: C_{IN} , C_{OUT} , C_1 , and C_2 : Low-ESR Surface-Mount Ceramic Capacitors (MLCCs) used in setting electrical characteristics

Note 10: $V_{\text{OUT (NOM)}}$ is the nominal output voltage of the part. An example: $V_{\text{OUT-NOM}}$ of LM2798MM-1.8 is 1.8V.

Note 11: Efficiency is measured versus V_{IN} , with V_{IN} being swept in small increments from 3.0V to 4.2V. The average is calculated from these measurement results. Weighting to account for battery voltage discharge characteristics (V_{BAT} vs. Time) is not done in computing the average.

Note 12: Turn-on time is measured from when the EN signal is pulled high until the output voltage crosses 90% of its final value. Resistive load used for startup measurement, with value chosen to give $I_{\text{OUT}} = 100\text{mA}$ when the output voltage is fully established.

Block Diagram

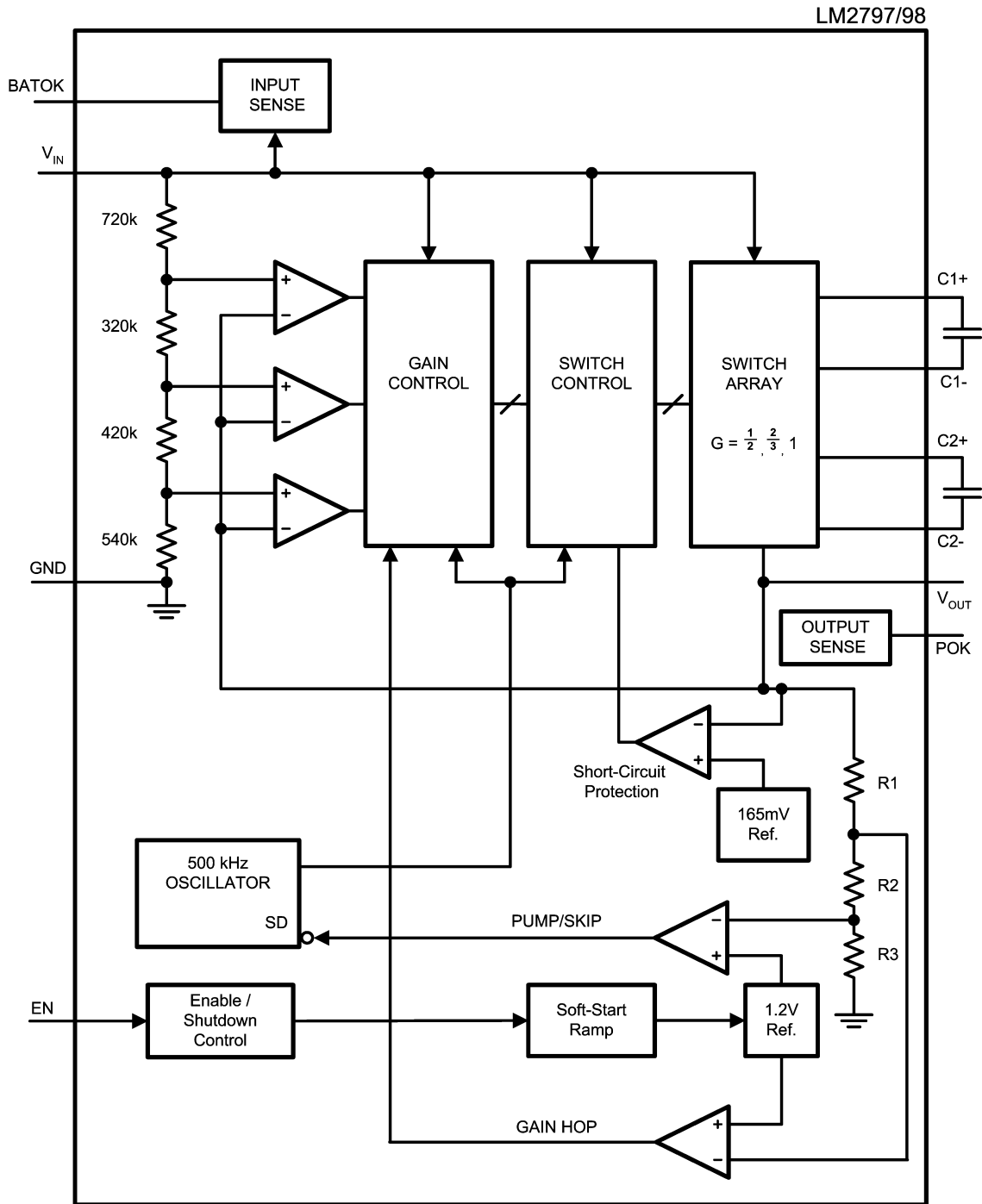

V _{OUT}	R1	R2	R3
1.5V	85 kΩ	5 kΩ	410 kΩ
1.8V	155 kΩ	5 kΩ	340 kΩ
2.0V	190 kΩ	5 kΩ	305 kΩ

20044503

Typical Performance Characteristics Unless otherwise specified: $C_{IN} = 10\mu\text{F}$, $C_1 = 1.0\mu\text{F}$, $C_2 = 1.0\mu\text{F}$, $C_{OUT} = 10\mu\text{F}$, $T_A = 25^\circ\text{C}$. Capacitors are low-ESR multi-layer ceramic capacitors (MLCC's).

**Output Voltage vs. Input Voltage:
LM2798-1.5 (1mA)**

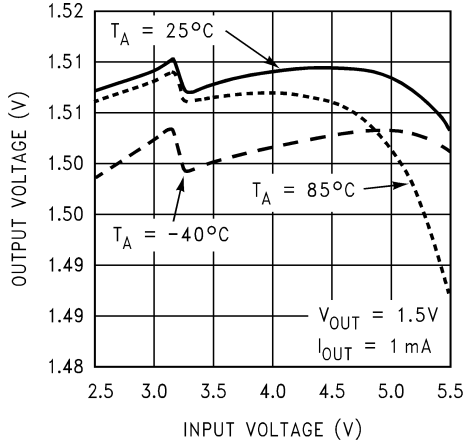

20044507

**Output Voltage vs. Input Voltage:
LM2798-1.5 (120mA)**

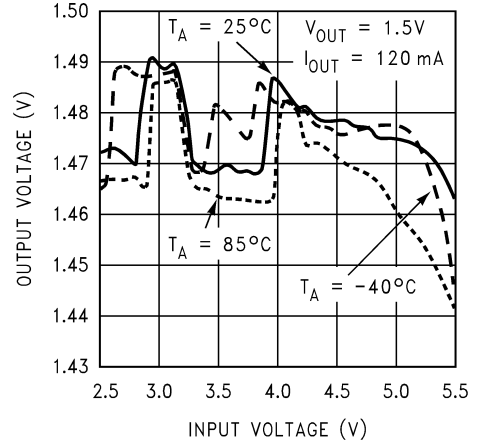

20044508

**Output Voltage vs. Input Voltage:
LM2797/98-1.8 (1mA)**

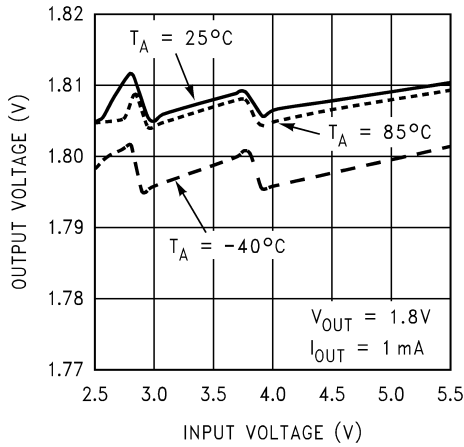

20044509

**Output Voltage vs. Input Voltage:
LM2797/98-1.8 (120mA)**

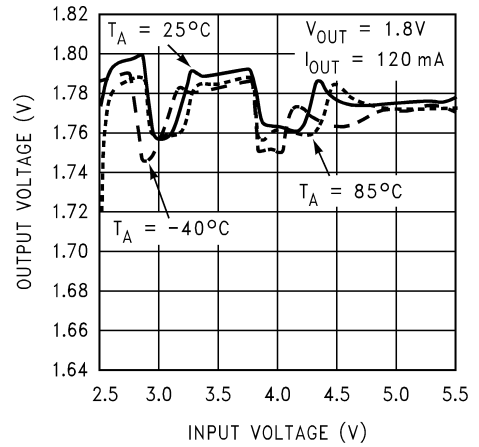

20044510

**Output Voltage vs. Input Voltage:
LM2798-2.0 (1mA)**

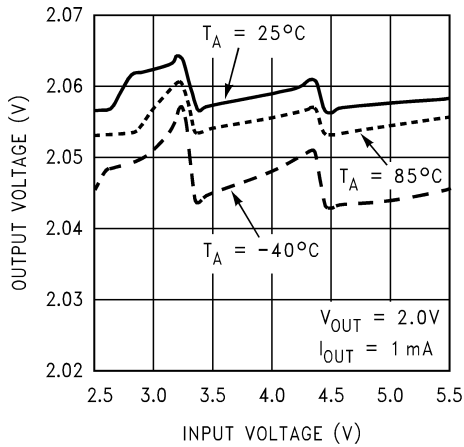

20044511

**Output Voltage vs. Input Voltage:
LM2798-2.0 (120mA)**

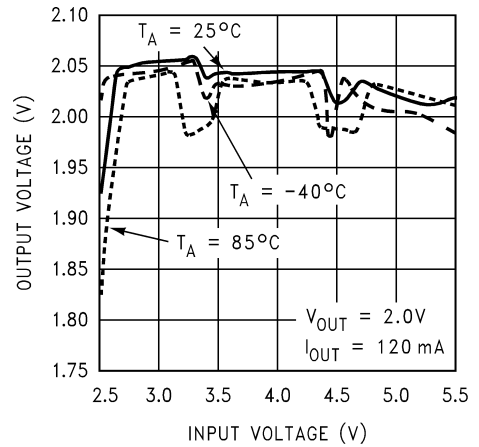

20044512

Typical Performance Characteristics Unless otherwise specified: $C_{IN} = 10\mu F$, $C1 = 1.0\mu F$, $C2 = 1.0\mu F$, $C_{OUT} = 10\mu F$, $T_A = 25^\circ C$. Capacitors are low-ESR multi-layer ceramic capacitors (MLCC's). (Continued)

Efficiency vs. Input Voltage: LM2798-1.5

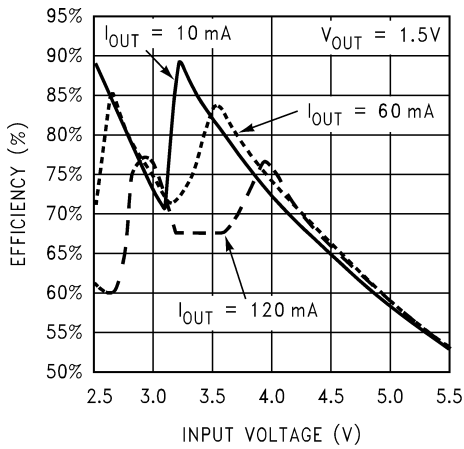

20044513

Efficiency vs. Output Current: LM2798-1.5

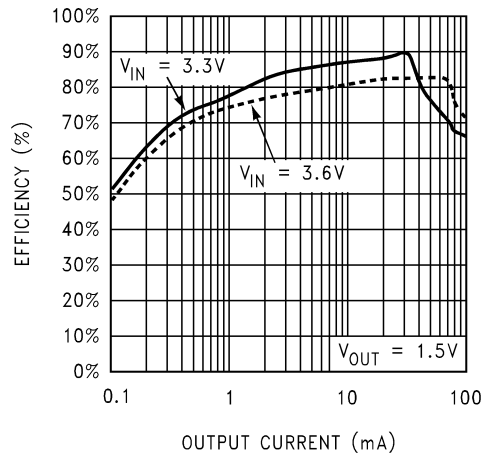

20044514

Efficiency vs. Input Voltage: LM2797/98-1.8

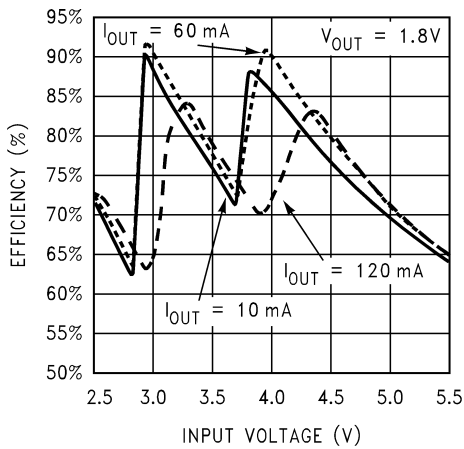

20044515

Efficiency vs. Output Current: LM2797/98-1.8

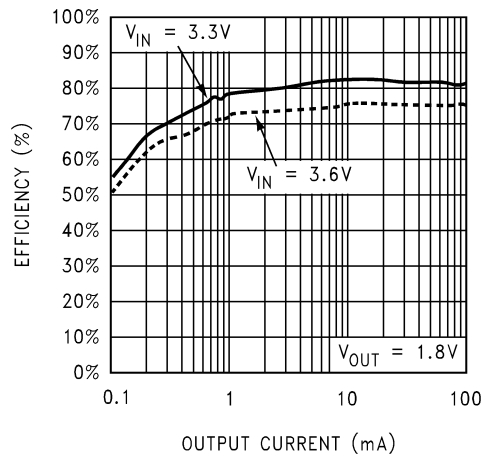

20044516

Efficiency vs. Input Voltage: LM2798-2.0

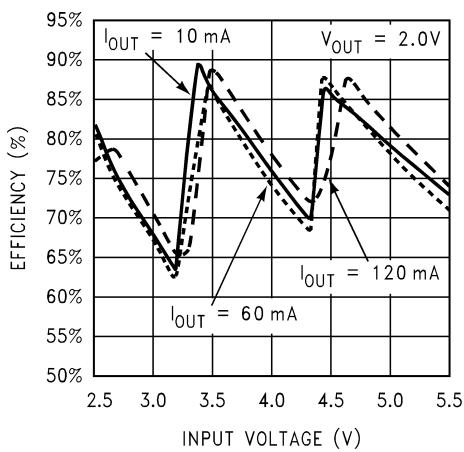

20044517

Efficiency vs. Output Current: LM2798-2.0

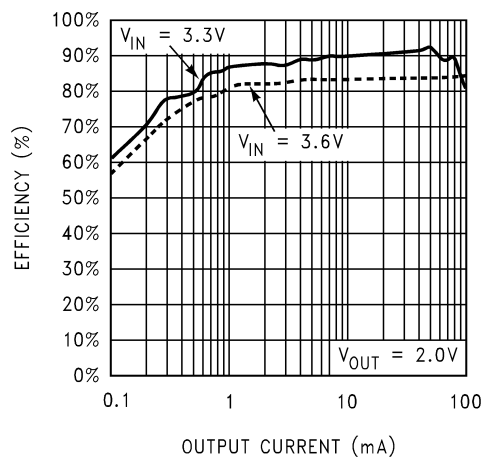

20044518

Typical Performance Characteristics Unless otherwise specified: $C_{IN} = 10\mu F$, $C1 = 1.0\mu F$, $C2 = 1.0\mu F$, $C_{OUT} = 10\mu F$, $T_A = 25^\circ C$. Capacitors are low-ESR multi-layer ceramic capacitors (MLCC's). (Continued)

Output Voltage Ripple vs. Output Current

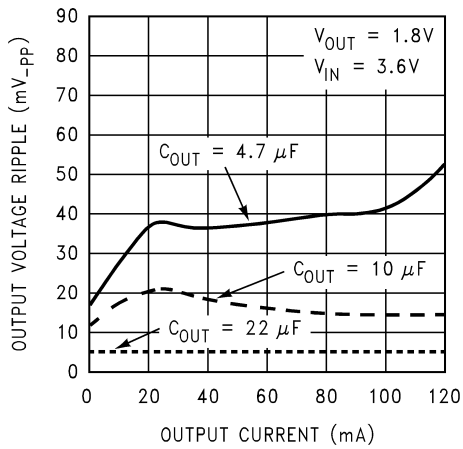

20044521

Output Voltage Ripple vs. Input Voltage

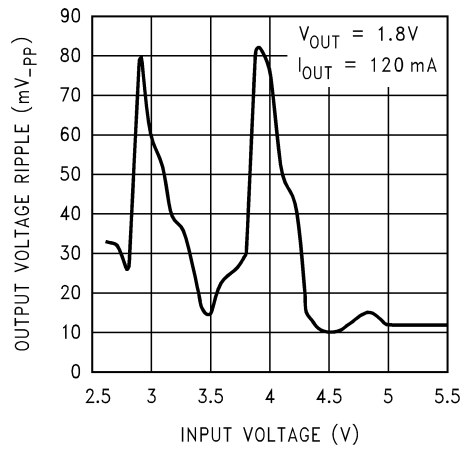

20044519

Output Voltage Ripple

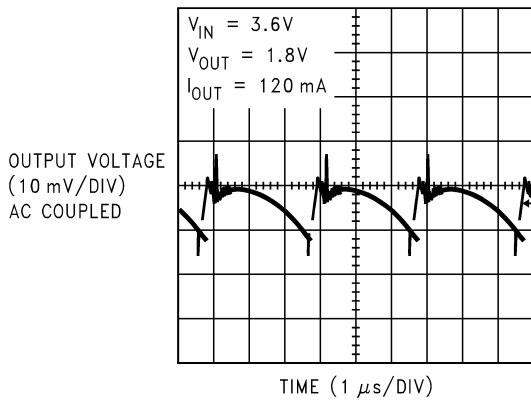

20044506

Short Circuit Current

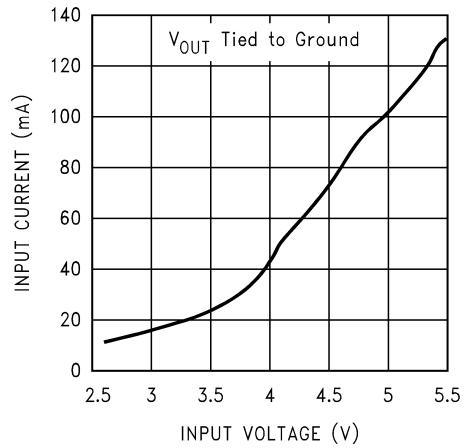

20044520

Start Up Waveform: LM2798-1.8

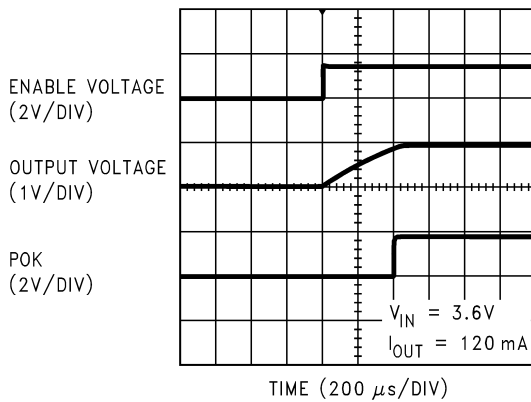

20044504

Transient Load Response

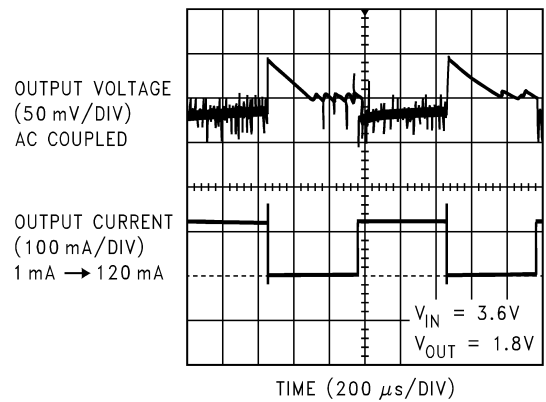

20044505

Operation Description

OVERVIEW

The LM2797/98 are switched capacitor converters that produce a regulated low-voltage output. The core of the parts is a highly efficient charge pump that utilizes multiple fractional gains and pulse-frequency modulated (PFM) switching to minimize power losses over wide input voltage and output current ranges. A description of the principal operational characteristics of the LM2797/98 is broken up into the following sections: **PFM Regulation, Fractional Multi-Gain Charge Pump, and Gain Selection for Optimal Efficiency.** Each of these sections refers to the block diagram presented on the previous page.

PFM REGULATION

The LM2797/98 achieves tightly regulated output voltages with pulse-frequency modulated (PFM) regulation. PFM simply means the part only pumps when it needs to. When the output voltage is above the target regulation voltage, the part idles and consumes minimal supply-current. In this state, the load current is supplied solely by the charge stored on the output capacitor. As this capacitor discharges and the output voltage falls below the target regulation voltage, the charge pump activates. Charge/current is delivered to the output (supplying the load and boosting the voltage on the output capacitor).

The primary benefit of PFM regulation is when output currents are light and the part is predominantly in the low-supply-current idle state. Net supply current is minimal because the part only occasionally needs to recharge the output capacitor by activating the charge pump.

FRACTIONAL MULTI-GAIN CHARGE PUMP

The core of the LM2797/98 is a two-phase charge pump controlled by an internally generated non-overlapping clock. The charge pump operates by using the external flying capacitors, C1 and C2, to transfer charge from the input to the output. During the charge phase, which doubles as the PFM "idle state", the flying capacitors are charged by the input supply. The charge pump will be in this state until the output voltage drops below the target regulation voltage, triggering the charge pump to activate so that it can deliver charge to the output. Charge transfer is achieved in the pump phase. In this phase, the fully charged flying capacitors are connected to the output so that the charge they hold can supply the load current and recharge the output capacitor.

Input, output, and intermediary connections of the flying capacitors are made with internal MOS switches. The LM2797/98 utilizes two flying capacitors and a versatile switch network to achieve several fractional voltage gains: $1/2$, $2/3$, and 1. With this gain-switching ability, it is as if the LM2797/98 is three-charge-pumps-in-one. The "active" charge pump at any given time is the one that will yield the highest efficiency given the input and output conditions present.

GAIN SELECTION AND GAIN HOPPING FOR OPTIMAL EFFICIENCY

The ability to switch gains based on input and output conditions results in optimal efficiency throughout the operating ranges of the LM2797/98. Charge-pump efficiency is derived in the following two ideal equations (supply current and other losses are neglected for simplicity):

$$I_{IN} = G \times I_{OUT}$$

$$E = (V_{OUT} \times I_{OUT}) \div (V_{IN} \times I_{IN}) = V_{OUT} \div (G \times V_{IN})$$

In the equations, G represents the charge pump gain. Efficiency is at its highest as $G \times V_{IN}$ approaches V_{OUT} . Optimal efficiency is achieved when gain is able to adjust depending on input and output voltage conditions. Due to the nature of charge pumps, G cannot adjust continuously, which would be ideal from an efficiency standpoint. But G can be a set of simple quantized ratios, allowing for a good degree of efficiency optimization.

The gain set of the LM2797/98 consists of the gains $1/2$, $2/3$, and 1. An internal input voltage range detector, along with the nominal output voltage of a given LM2797/98 option, determines what is to be referred to as the "base gain" of the part, G_B . The base gain is the default gain configuration of the part over a set V_{IN} range. Table 1 lists G_B of the LM2798-1.8 over the input voltage range. For the remainder of this discussion, the 1.8V option of the LM2798 will be used as an example. The other voltage options of the LM2798 operate under the same principles as LM2798-1.8, the gain transitions merely occur at different input voltages. Since the only difference between the LM2797 and the LM2798 is start-up time, the modes of operation of the LM2798-1.8 discussed here are identical to those of the LM2797-1.8.

TABLE 1. LM2798-1.8 Base Gain (G_B) vs. V_{IN}

Input Voltage	Base Gain (G_B)
2.6V - 2.9V	1
2.9V - 3.8V	$2/3$
3.8V - 5.5V	$1/2$

Figure 1 shows the efficiency of the LM2798-1.8 versus input voltage, with output currents of 10mA and 120mA. The base gain regions (G_B) are separated and labeled. There is also a set of ideal efficiency gradients, $E_{IDEAL(G=xx)}$, showing the ideal efficiency of a charge pumps with gains of $1/2$, $2/3$, and 1. These gradients have been generated using the ideal efficiency equation presented above.

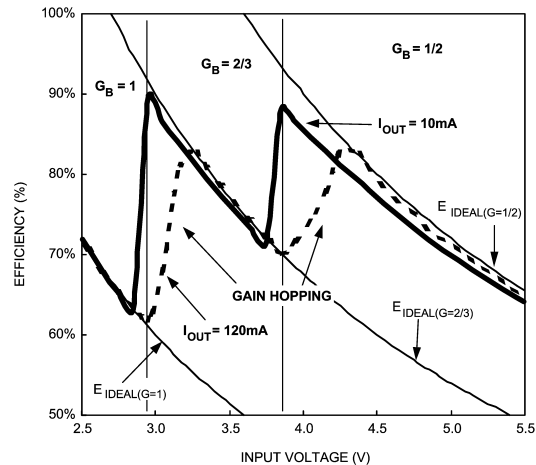

20044522

FIGURE 1. Efficiency of LM2798-1.8 with 10mA and 120mA output currents. Base-gain (G_B) regions are separated and labeled. Ideal efficiency curves of charge pumps with $G = 1/2$, $2/3$, and 1 are included, and are labelled:

$$E_{IDEAL(G=1)}, E_{IDEAL(G=2/3)}, E_{IDEAL(G=1/2)}$$

Operation Description (Continued)

The 10mA load curve in *Figure 1* gives a clear picture of how base-gain affects overall converter efficiency. The "ideal efficiency gradients" in the figure show the efficiency of ideal switched capacitor converters with gains of 1, 2/3, and 1/2, respectively. The 10mA-load efficiency curve closely follows the ideal efficiency gradients in each of the respective base-gain regions. At the base-gain transitions ($V_{IN} = 2.9V, 3.8V$), there are sharp transitions in the 10mA curve because the LM2797/98 switches base-gains. With a 10mA output current there is very little gain hopping (described below), and the gain of the LM2798-1.8 is equal to the base-gain over the entire operating input voltage range. Internal supply current has a minimal impact on efficiency with a 10 mA load. Supply current does have a small effect, and it is the reason why the 10mA load curve is slightly below the ideal efficiency gradients in each of the base-gain regions. But overall, due to the lack of gain hopping and the minimal impact of supply current on converter efficiency, the 10mA load curve very closely mirrors the ideal efficiency curves in each of the respective base-gain regions.

The 120mA-load curve in *Figure 1* illustrates the effect of gain hopping on converter efficiency. Gain hopping is implemented to overcome output voltage droop that results from charge-pump non-idealities. In an ideal charge pump, the output voltage is equal to the product of the gain and the input voltage. Non-idealities such as finite switch resistance, capacitor ESR, and other factors result in the output of practical charge pumps being below the ideal value. This output droop is typically modeled as an output resistance, R_{OUT} , because the magnitude of the droop increases linearly with load current.

$$\text{Ideal Charge Pump: } V_{OUT} = G \times V_{IN}$$

$$\text{Real Charge Pump: } V_{OUT} = (G \times V_{IN}) - (I_{OUT} \times R_{OUT})$$

The LM2797/98 compensates for output voltage droop under high load conditions by gain hopping. When the base-gain is not sufficient to keep the output voltage in regulation, the part will temporarily hop up to the next highest gain setting to provide an intermittent boost in output voltage. When the output voltage is sufficiently boosted, the gain configuration reverts back to the base-gain setting. An example: if the input voltage of the LM2798-1.8 is 3.2V, the part is in the 2/3 base-gain region. If the output voltage droops, the gain configuration will temporarily hop up to a gain of 1. It will operate with a gain of 1 until the nominal output voltage is restored, at which time the gain will hop back down to 2/3. If the load remains high, the part will continue to hop back and forth between the base-gain and the next highest gain setting, and the output voltage will remain in regulation. In contrast to the base-gain decision, which is made based on the input voltage, the decision to gain hop is made by monitoring the voltage at the output of the part.

TABLE 3. Typical POK functionality, with 1M Ω pull-up resistor connected between POK and V_{OUT}

V _{IN}	EN	V _{OUT}	POK State	Internal POK Transistor State	V(POK)
>1.7V	H	>95% of V _{OUT-nom}	HIGH	OFF	V _{OUT}
>1.7V	H	≤ 92% OF V _{OUT-nom}	LOW	ON	0V
>1.7V	L	X	LOW	ON	0V
<1.7V	X	X	LOW	OFF	0V, (V _{OUT} off)

The 120mA-load efficiency curve in *Figure 1* illustrates the effect of gain hopping on efficiency. Comparing the 120mA load curve to the 10mA load curve, notice that to the right of the base-gain transitions the efficiency of the 120mA curve increases gradually. In contrast, the 10mA curve makes a very sharp transition. The base-gain of both curves is the same for both loads. The difference comes in gain hopping. With the 120mA load, the part operates in the base-gain setting for a certain percentage of time and in the next-highest gain setting for the remainder. The percentage of time spent in an elevated gain configuration decreases as the input voltage rises, as less gain-hopping boost is required with increased input voltage. When the input voltage in a given base-gain region is large enough so that no extra boost from gain hopping is required, the part operates entirely in the base gain region. This can be seen in the figure where the 120mA-load efficiency curve follows the ideal efficiency gradients.

TABLE 2. LM2798-1.8 Gain Hopping Regions

Input Voltage	Base Gain (G _B)	Gain Hop Setting
3.0V - 3.3V	2/3	1
3.8V - 4.4V	1/2	2/3

Gain hopping contributes to the overall high efficiency of the LM2797/98. Gain hopping only occurs when required to keep the output voltage in regulation. This allows the LM2797/98 to operate in the higher efficiency base-gain setting as much as possible. Gain hopping also allows the base-gain transitions to be placed at input voltages that are as low as practically possible. Doing so maximizes the peaks and minimizes the valleys of the efficiency "saw-tooth" curves, maximizing total solution efficiency.

POK: OUTPUT VOLTAGE STATUS INDICATOR

The POK pin is an NMOS-open-drain-logic signal that indicates when the output voltage of the LM2797/98 is at or above 95% (typ) of the target output voltage. To function properly, the POK pin must be connected to a pull-up resistor (1M Ω (typ.)), or other pull-up device. With a pull-up in place, V(POK) will be HIGH when V_{OUT} is at or above 95% (typ) of the nominal output voltage (V_{OUT-nom} = 1.5V, 1.8V, or 2.0V, depending on voltage option). If the output falls below 92% (typ.) of the nominal output voltage, V(POK) will be 0V. There is hysteresis of 3% between the thresholds. The POK function is disabled and V(POK) is pulled down to 0V when the LM2797/98 is in shutdown (EN = 0V). *Table 3* is a complete list of the typical POK regions of operation.

Operation Description (Continued)

TABLE 4. Typical BATOK functionality, with 1MΩ pull-up resistor connected between BATOK and V_{IN}

V _{IN}	EN	BATOK State	Internal BATOK Transistor State	V(BATOK)
> 2.85V	H	HIGH	OFF	V _{IN}
> 1.1V, < 2.65V	H	LOW	ON	0V
> 1.1V	L	LOW	ON	0V
≤ 1.1V	X	LOW	OFF	V _{IN} , ≤ 1.1V

BATOK: INPUT VOLTAGE STATUS INDICATOR

The BATOK pin is an NMOS-open-drain-logic signal that indicates the status of the input voltage. To function properly, the BATOK pin must be connected to a pull-up resistor, or other pull-up device. With a pull-up in place, V(BATOK) will be HIGH when V_{IN} is at or above 2.85V. If the output falls below 2.65V (typ.), V(BATOK) will be 0V. There is hysteresis of 20mV (typ.) between the thresholds. The BATOK function is disabled and V(BATOK) is pulled down to 0V when the LM2797/98 is in shutdown (EN = 0V). Table 4 is a complete list of the typical BATOK regions of operation.

SHUTDOWN

The LM2797/98 is in shutdown mode when the voltage on the active-low logic enable pin (EN) is low. In shutdown, the LM2797/98 draws virtually no supply current. When in shutdown, the output of the LM2797/98 is completely disconnected from the input, and will be 0V unless driven by an outside source.

In some applications, it may be desired to disable the LM2797/98 and drive the output pin with another voltage source. This can be done, but the voltage on the output pin of the LM2797/98 must not be brought above the input voltage. The output pin will draw a small amount of current when driven externally due to the internal feedback resistor divider connected between V_{OUT} and GND.

SOFT START

The LM2797/98 employs soft start circuitry to prevent excessive input inrush currents during startup. At startup, the output voltage gradually rises from 0V to the nominal output voltage. This occurs in 400μs (typ.) with the LM2798. Turn-on time of the LM2797 is 100μs (typ.). Soft-start is engaged when the part is enabled, including situations where voltage is established simultaneously on the V_{IN} and EN pins.

THERMAL SHUTDOWN

Protection from overheating-related damage is achieved with a thermal shutdown feature. When the junction temperature rises to 150°C (typ.), the part switches into shutdown mode. The LM2797/98 disengages thermal shutdown when the junction temperature of the part is reduced to 130°C (typ.). Due to its high efficiency, the LM2797/98 should not activate thermal shutdown (or exhibit related thermal cycling) when the part is operated within specified input voltage, output current, and ambient temperature operating ratings.

SHORT-CIRCUIT PROTECTION

The LM2797/98 short-circuit protection circuitry protects the device in the event of excessive output current and/or output shorts to ground. A graph of "Short-Circuit Current vs. Input Voltage" is provided in the **Performance Characteristics** section.

Application Information

OUTPUT VOLTAGE RIPPLE

The voltage ripple on the output of the LM2797/98 is highly dependent on application conditions. The output capacitor, the input voltage, and the output current each play a significant part in determining the output voltage ripple. Due to the complexity of LM2797/98 operation, providing equations or models to approximate the magnitude of the ripple cannot be easily accomplished. The following general statements can be made, however

The output capacitor will have a significant effect on output voltage ripple magnitude. Ripple magnitude will typically be linearly proportional to the output capacitance present. A low-ESR ceramic capacitor is recommended on the output to keep output voltage ripple low. Placing multiple capacitors in parallel can reduce ripple significantly. Doing this increases capacitance and reduces ESR (the effective net ESR is governed by the properties of parallel resistance). Placing two identical capacitors in parallel have twice the capacitance and half the ESR, as compared to one of these capacitors all by itself. Similarly, if a large-value, high-ESR capacitor (tantalum, for example) is to be used as the primary output capacitor, the net output ESR can be significantly reduced by placing a low-ESR ceramic capacitor in parallel with this primary output capacitor.

Ripple is increased when the LM2797/98 is gain hopping. With high output currents, ripple is likely to vary significantly with input voltage, depending on whether on not the part is gain hopping.

CAPACITORS

The LM2797/98 requires 4 external capacitors for proper operation. Surface-mount multi-layer ceramic capacitors are recommended. These capacitors are small, inexpensive and have very low equivalent series resistance (ESR, ≤ 15mΩ typ.). Tantalum capacitors, OS-CON capacitors, and aluminum electrolytic capacitors generally are not recommended for use with the LM2797/98 due to their high ESR, as compared to ceramic capacitors.

For most applications, ceramic capacitors with an X7R or X5R temperature characteristic are preferred for use with the LM2797/98. These capacitors have tight capacitance tolerance (as good as ±10%) and hold their value over temperature (X7R: ±15% over -55°C to 125°C; X5R: ±15% over -55°C to 85°C).

Application Information (Continued)

Capacitors with a Y5V or Z5U temperature characteristic are generally not recommended for use with the LM2797/98. These types of capacitors typically have wide capacitance tolerance (+80%, -20%) and vary significantly over temperature (Y5V: +22%, -82% over -30°C to +85°C range; Z5U: +22%, -56% over +10°C to +85°C range). Under some conditions, a 1µF-rated Y5V or Z5U capacitor could have a capacitance as low as 0.1µF. Such detrimental deviation is likely to cause these Y5V and Z5U capacitors to fail to meet the minimum capacitance requirements of the LM2797/98.

The table below lists some leading ceramic capacitor manufacturers.

Manufacturer	Contact Information
AVX	www.avx.com
Murata	www.murata.com
Taiyo-Yuden	www.t-yuden.com
TDK	www.component.tdk.com
Vishay-Vitramon	www.vishay.com

OUTPUT CAPACITOR

The output capacitor of the LM2797/98 greatly affect performance of the circuit. In typical high-current applications, a 10µF low-ESR (ESR = equivalent series resistance) ceramic capacitor is recommended. For lighter loads, the output capacitance may be reduced (as low as 1µF for output currents ≤ 60mA is usually acceptable). The performance of the part should be evaluated with special attention paid to efficiency and output ripple to ensure the capacitance chosen on the output yields performance suitable for the application. In extreme cases, excessive ripple could cause control loop instability, severely affecting the performance of the part. If excessive ripple is present, the output capacitance should be increased.

The ESR of the output capacitor affects charge pump output resistance, which plays a role in determining output current capability. Both output capacitance and ESR affect output voltage ripple (See Output Voltage Ripple section, above). For these reasons, a low-ESR X7R/X5R ceramic capacitor is the capacitor of choice for the LM2797/98 output.

FLYING CAPACITORS

The flying capacitors (C₁ and C₂) transfer charge from the input to the output, and determine the strength of the charge pump: the larger the capacitance, the greater the output current capability. If capacitors are too small, the LM2797/98 could spend excessive amount of time gain hopping: decreasing efficiency, increasing output voltage ripple, and possibly impeding the ability of the part to regulate. On the other hand, if the flying capacitors are too large they could potentially overwhelm the output capacitor, resulting in increased output voltage ripple.

Low-ESR ceramic capacitors with X7R or X5R temperature characteristic are strongly recommended for use here. The flying capacitors C₁ and C₂ should be identical. As a general rule, the capacitance value of each flying capacitor should be 1/10th that of the output capacitor. ESR should be as low as possible to minimize the output resistance of the charge pump and give maximum output current capability. Polarized capacitor (tantalum, aluminum electrolytic, etc.) must not be used for the flying capacitors, as they could become reverse-biased upon start-up of the LM2797/98.

INPUT CAPACITOR

The input capacitor (C_{IN}) is a reservoir of charge that aids a quick transfer of charge from the supply to the flying capacitors during the charge phase of operation. The input capacitor helps to keep the input voltage from drooping at the start of the charge phase when the flying capacitor is connected to the input, and helps to filter noise on the input pin that could adversely affect sensitive internal analog circuitry biased off the input line. An X7R/X5R ceramic capacitor is recommended for use. As a general recommendation, the input capacitor should be chosen to match the output capacitor.

POWER DISSIPATION

LM2797/98 power dissipation will, typically, not be much of a concern in most applications. Derating to accommodate self-heating will rarely be required due to the high efficiency of the part. Peak power dissipation (P_D) of all LM2797/98 options is seen with the LM2798-1.5 operating at V_{IN} = 5.5V and I_{OUT} = 120mA (conditions limited to valid operating ratings). Under these conditions, the power efficiency (E) of the LM2798-1.5 is 54% (typ.). Assuming a typical junction-to-ambient thermal resistance (θ_{JA}) for the MSOP package of 220°C/Watt, the junction temperature (T_J) of the part is calculated below for a part operating at the maximum rated ambient temperature (T_A) of 85°C.

$$\begin{aligned}
 P_D &= P_{IN} - P_{OUT} \\
 &= (P_{OUT}/E) - P_{OUT} \\
 &= [(1/E) - 1] \times P_{OUT} \\
 &= [(1/64\%) - 1] \times 1.5V \times 120mW \\
 &= 153mW
 \end{aligned}$$

$$\begin{aligned}
 T_J &= T_A + (P_D \times \theta_{JA}) \\
 &= 85^\circ\text{C} + (.153W \times 220^\circ\text{C/W}) \\
 &= 119^\circ\text{C}
 \end{aligned}$$

Even under these peak power dissipation and ambient temperature conditions, the junction temperature of the LM2798-1.5 is below the maximum operating rating of 125°C.

As an additional note, the ambient temperature operating rating range listed in the specifications is provided merely for convenience. The LM2797/98 may be operated outside this rating, so long as the junction temperature of the device does not exceed the maximum operating rating of 125°C.

Layout Guidelines

Proper board layout to accommodate the LM2797/98 circuit will help to ensure optimal performance. The following guidelines are recommended:

- Place capacitors as close to the LM2797/98 as possible, and preferably on the same side of the board as the IC.
- Use short, wide traces to connect the external capacitors to the LM2797/98 to minimize trace resistance and inductance.

- Use a low resistance connection between ground and the GND pin of the LM2797/98. Using wide traces and/or multiple vias to connect GND to a ground plane on the board is most advantageous.

Figure 2 is a sample single-layer board layout that accommodates the LM2797/98 typical application circuit, as pictured on the cover of this datasheet

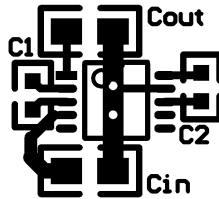

20044524

FIGURE 2. Sample single-layer board layout of the LM2797/98 Typical Application Circuit
(Vias to a ground plane, assumed to be present, are located in the center of the LM2797/98 footprint.)

Physical Dimensions inches (millimeters) unless otherwise noted

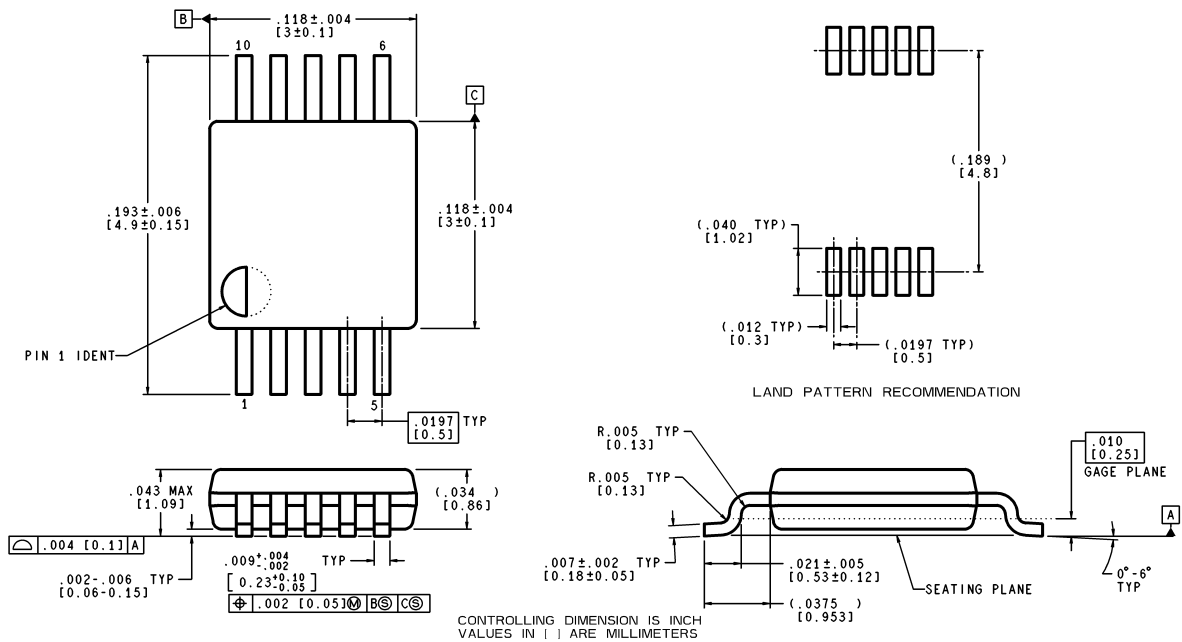

MUB10A (Rev A)

**Mini SOP-10 (MSOP-10)
MUB10A**

LIFE SUPPORT POLICY

NATIONAL'S PRODUCTS ARE NOT AUTHORIZED FOR USE AS CRITICAL COMPONENTS IN LIFE SUPPORT DEVICES OR SYSTEMS WITHOUT THE EXPRESS WRITTEN APPROVAL OF THE PRESIDENT AND GENERAL COUNSEL OF NATIONAL SEMICONDUCTOR CORPORATION. As used herein:

1. Life support devices or systems are devices or systems which, (a) are intended for surgical implant into the body, or (b) support or sustain life, and whose failure to perform when properly used in accordance with instructions for use provided in the labeling, can be reasonably expected to result in a significant injury to the user.
2. A critical component is any component of a life support device or system whose failure to perform can be reasonably expected to cause the failure of the life support device or system, or to affect its safety or effectiveness.



National Semiconductor
Americas Customer
Support Center
Email: new.feedback@nsc.com
Tel: 1-800-272-9959

National Semiconductor
Europe Customer Support Center
Fax: +49 (0) 180-530 85 86
Email: europe.support@nsc.com
Deutsch Tel: +49 (0) 69 9508 6208
English Tel: +44 (0) 870 24 0 2171
Français Tel: +33 (0) 1 41 91 8790

National Semiconductor
Asia Pacific Customer
Support Center
Fax: +65-6250 4466
Email: ap.support@nsc.com
Tel: +65-6254 4466

National Semiconductor
Japan Customer Support Center
Fax: 81-3-5639-7507
Email: jpn.feedback@nsc.com
Tel: 81-3-5639-7560

www.national.com