

# LMV771/LMV772/LMV774

## Single/Dual/Quad, Low Offset, Low Noise, RRO Operational Amplifiers

### General Description

The LMV771/LMV772/LMV774 are Single, Dual, and Quad low noise precision operational amplifiers intended for use in a wide range of applications. Other important characteristics of the family include extended operating temperature range,  $-40^{\circ}\text{C}$  to  $125^{\circ}\text{C}$ , tiny SC70-5 package for LMV771, and low input bias current.

The extended temperature range of  $-40^{\circ}\text{C}$  to  $125^{\circ}\text{C}$  allows the LMV771/LMV772/LMV774 to accommodate a broad range of applications. LMV771 expands National Semiconductor's Silicon Dust™ amplifier portfolio offering enhancements in size, speed, and power savings. The LMV771/LMV772/LMV774 are guaranteed to operate over the voltage range of 2.7V to 5.0V and all have rail-to-rail output.

The LMV771/LMV772/LMV774 family is designed for precision, low noise, low voltage, and miniature systems. These amplifiers provide rail-to-rail output swing into heavy loads. The maximum input offset voltage for LMV771 is  $850\ \mu\text{V}$  at room temperature and the input common mode voltage range includes ground.

The LMV771 is offered in the tiny SC70-5 package, LMV772 in space saving MSOP-8 and SOIC-8, and the LMV774 in TSSOP-14.

### Features

(Typical 2.7V Supply Values; Unless Otherwise Noted)

- Guaranteed 2.7V and 5V specifications
- Maximum  $V_{OS}$  (LMV771) 850 $\mu\text{V}$  (limit)
- Voltage Noise
  - $f = 100\text{Hz}$  12.5nV/ $\sqrt{\text{Hz}}$
  - $f = 10\text{kHz}$  7.5nV/ $\sqrt{\text{Hz}}$
- Rail-to-Rail output swing
  - w/600 $\Omega$  load 100mV from rail
  - w/2k $\Omega$  load 50mV from rail
- Open loop gain w/2k $\Omega$  load 100dB
- $V_{CM}$  0 to  $V^+$  -0.9V
- Supply current (per amplifier) 550 $\mu\text{A}$
- Gain bandwidth product 3.5MHz
- Temperature range  $-40^{\circ}\text{C}$  to  $125^{\circ}\text{C}$

### Applications

- Transducer amplifier
- Instrumentation amplifier
- Precision current sensing
- Data acquisition systems
- Active filters and buffers
- Sample and hold
- Portable/battery powered electronics

### Connection Diagram

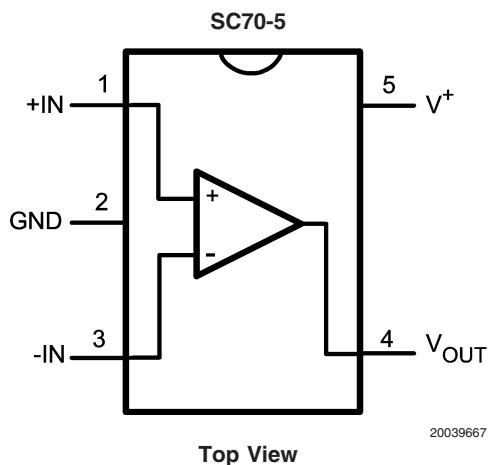

20039667

### Instrumentation Amplifier

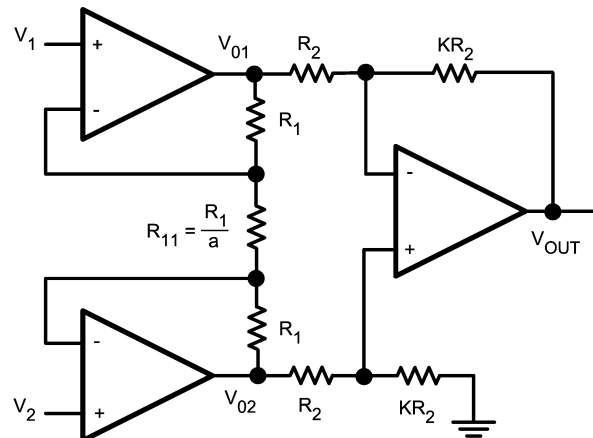

20039636

$$V_O = -K(2a + 1)(V_1 - V_2)$$

**Absolute Maximum Ratings** (Note 1)

If Military/Aerospace specified devices are required, please contact the National Semiconductor Sales Office/Distributors for availability and specifications.

ESD Tolerance (Note 2)	
Machine Model	200V
Human Body Model	2000V
Differential Input Voltage	± Supply Voltage
Supply Voltage ( $V^+ - V^-$ )	5.5V
Output Short Circuit to $V^+$	(Note 3)
Output Short Circuit to $V^-$	(Note 4)
Mounting Temperature	
Infrared or Convection (20 sec)	235°C
Wave Soldering Lead Temp (10 sec)	260°C

Storage Temperature Range	-65°C to 150°C
Junction Temperature (Note 5)	150°C

**Operating Ratings** (Note 1)

Supply Voltage	2.7V to 5.5V
Temperature Range	-40°C to 125°C
Thermal Resistance ( $\theta_{JA}$ )	
SC70-5 Package	440 °C/W
8-Pin MSOP	235°C/W
8-Pin SOIC	190°C/W
14-Pin TSSOP	155°C/W

**2.7V DC Electrical Characteristics** (Note 13)

Unless otherwise specified, all limits guaranteed for  $T_J = 25^\circ\text{C}$ .  $V^+ = 2.7\text{V}$ ,  $V^- = 0\text{V}$ ,  $V_{CM} = V^+/2$ ,  $V_O = V^+/2$  and  $R_L > 1\text{M}\Omega$ . **Boldface** limits apply at the temperature extremes.

Symbol	Parameter	Condition	Min (Note 7)	Typ (Note 6)	Max (Note 7)	Units
$V_{OS}$	Input Offset Voltage	LMV771		0.3	0.85 <b>1.0</b>	mV
		LMV772/LMV774		0.3	1.0 <b>1.2</b>	
$TCV_{OS}$	Input Offset Voltage Average Drift			-0.45		$\mu\text{V}/^\circ\text{C}$
$I_B$	Input Bias Current (Note 8)			-0.1	100	$\mu\text{A}$
$I_{OS}$	Input Offset Current (Note 8)			0.004	100	$\mu\text{A}$
$I_S$	Supply Current (Per Amplifier)			550	900 <b>910</b>	$\mu\text{A}$
CMRR	Common Mode Rejection Ratio	$0.5 \leq V_{CM} \leq 1.2\text{V}$	74 <b>72</b>	80		dB
PSSR	Power Supply Rejection Ratio	$2.7\text{V} \leq V^+ \leq 5\text{V}$	82 <b>76</b>	90		dB
$V_{CM}$	Input Common-Mode Voltage Range	For CMRR $\geq 50\text{dB}$	0		1.8	V
$A_V$	Large Signal Voltage Gain (Note 9)	$R_L = 600\Omega$ to 1.35V, $V_O = 0.2\text{V}$ to 2.5V, (Note 10)	92 <b>80</b>	100		dB
		$R_L = 2\text{k}\Omega$ to 1.35V, $V_O = 0.2\text{V}$ to 2.5V, (Note 11)	98 <b>86</b>	100		
$V_O$	Output Swing	$R_L = 600\Omega$ to 1.35V $V_{IN} = \pm 100\text{mV}$ , (Note 10)	0.11 <b>0.14</b>	0.084 to 2.62	2.59 <b>2.56</b>	V
		$R_L = 2\text{k}\Omega$ to 1.35V $V_{IN} = \pm 100\text{mV}$ , (Note 11)	0.05 <b>0.06</b>	0.026 to 2.68	2.65 <b>2.64</b>	
$I_O$	Output Short Circuit Current	Sourcing, $V_O = 0\text{V}$ $V_{IN} = 100\text{mV}$	18 <b>11</b>	24		mA
		Sinking, $V_O = 2.7\text{V}$ $V_{IN} = -100\text{mV}$	18 <b>11</b>	22		

## 2.7V AC Electrical Characteristics (Note 13)

Unless otherwise specified, all limits guaranteed for  $T_J = 25^\circ\text{C}$ .  $V^+ = 5.0\text{V}$ ,  $V^- = 0\text{V}$ ,  $V_{\text{CM}} = V^+/2$ ,  $V_O = V^+/2$  and  $R_L > 1\text{M}\Omega$ . **Boldface** limits apply at the temperature extremes.

Symbol	Parameter	Conditions	Min (Note 7)	Typ (Note 6)	Max (Note 7)	Units
SR	Slew Rate	(Note 12)		1.4		V/ $\mu\text{s}$
GBW	Gain-Bandwidth Product			3.5		MHz
$\Phi_m$	Phase Margin			79		Deg
$G_m$	Gain Margin			-15		dB
$e_n$	Input-Referred Voltage Noise (Flatband)	$f = 10\text{kHz}$		7.5		nV/ $\sqrt{\text{Hz}}$
$e_n$	Input-Referred Voltage Noise (1/f)	$f = 100\text{Hz}$		12.5		nV/ $\sqrt{\text{Hz}}$
$i_n$	Input-Referred Current Noise	$f = 1\text{kHz}$		0.001		pA/ $\sqrt{\text{Hz}}$
THD	Total Harmonic Distortion	$f = 1\text{kHz}$ , $A_V = +1$ $R_L = 600\Omega$ , $V_{\text{IN}} = 1 V_{\text{PP}}$		0.007		%

## 5.0V DC Electrical Characteristics (Note 13)

Unless otherwise specified, all limits guaranteed for  $T_J = 25^\circ\text{C}$ .  $V^+ = 5.0\text{V}$ ,  $V^- = 0\text{V}$ ,  $V_{\text{CM}} = V^+/2$ ,  $V_O = V^+/2$  and  $R_L > 1\text{M}\Omega$ . **Boldface** limits apply at the temperature extremes.

Symbol	Parameter	Condition	Min (Note 7)	Typ (Note 6)	Max (Note 7)	Units
$V_{\text{OS}}$	Input Offset Voltage	LMV771		0.25	0.85 <b>1.0</b>	mV
		LMV772/LMV774		0.25	1.0 <b>1.2</b>	
$\text{TCV}_{\text{OS}}$	Input Offset Voltage Average Drift			-0.35		$\mu\text{V}/^\circ\text{C}$
$I_B$	Input Bias Current (Note 8)			-0.23	100	pA
$I_{\text{OS}}$	Input Offset Current (Note 8)			0.017	100	pA
$I_S$	Supply Current (Per Amplifier)			600	950 <b>960</b>	$\mu\text{A}$
CMRR	Common Mode Rejection Ratio	$0.5 \leq V_{\text{CM}} \leq 3.5\text{V}$	80 <b>79</b>	90		dB
PSRR	Power Supply Rejection Ratio	$2.7\text{V} \leq V^+ \leq 5\text{V}$	82 <b>76</b>	90		dB
$V_{\text{CM}}$	Input Common-Mode Voltage Range	For CMRR $\geq 50\text{dB}$	0		4.1	V
$A_V$	Large Signal Voltage Gain (Note 9)	$R_L = 600\Omega$ to 2.5V, $V_O = 0.2\text{V}$ to 4.8V, (Note 10)	92 <b>89</b>	100		dB
		$R_L = 2\text{k}\Omega$ to 2.5V, $V_O = 0.2\text{V}$ to 4.8V, (Note 11)	98 <b>95</b>	100		
$V_O$	Output Swing	$R_L = 600\Omega$ to 2.5V $V_{\text{IN}} = \pm 100\text{mV}$ , (Note 10)	0.15 <b>0.23</b>	0.112 to 4.9	4.85 <b>4.77</b>	V
		$R_L = 2\text{k}\Omega$ to 2.5V $V_{\text{IN}} = \pm 100\text{mV}$ , (Note 11)	0.06 <b>0.07</b>	0.035 to 4.97	4.94 <b>4.93</b>	
$I_O$	Output Short Circuit Current (Note 8),(Note 14)	Sourcing, $V_O = 0\text{V}$ $V_{\text{IN}} = 100\text{mV}$	35 <b>35</b>	75		mA
		Sinking, $V_O = 2.7\text{V}$ $V_{\text{IN}} = -100\text{mV}$	35 <b>35</b>	66		

## 5.0V AC Electrical Characteristics (Note 13)

Unless otherwise specified, all limits guaranteed for  $T_J = 25^\circ\text{C}$ .  $V^+ = 5.0\text{V}$ ,  $V^- = 0\text{V}$ ,  $V_{\text{CM}} = V^+/2$ ,  $V_O = V^+/2$  and  $R_L > 1\text{M}\Omega$ .

**Boldface** limits apply at the temperature extremes.

Symbol	Parameter	Conditions	Min (Note 7)	Typ (Note 6)	Max (Note 7)	Units
SR	Slew Rate	(Note 12)		1.4		V/ $\mu\text{s}$
GBW	Gain-Bandwidth Product			3.5		MHz
$\Phi_m$	Phase Margin			79		Deg
$G_m$	Gain Margin			-15		dB
$e_n$	Input-Referred Voltage Noise (Flatband)	$f = 10\text{kHz}$		6.5		nV/ $\sqrt{\text{Hz}}$
$e_n$	Input-Referred Voltage Noise (1/f)	$f = 100\text{Hz}$		12		nV/ $\sqrt{\text{Hz}}$
$i_n$	Input-Referred Current Noise	$f = 1\text{kHz}$		0.001		pA/ $\sqrt{\text{Hz}}$
THD	Total Harmonic Distortion	$f = 1\text{kHz}$ , $A_V = +1$ $R_L = 600\Omega$ , $V_{\text{IN}} = 1 V_{\text{PP}}$		0.007		%

**Note 1:** Absolute Maximum Ratings indicate limits beyond which damage to the device may occur. Operating Ratings indicate conditions for which the device is intended to be functional, but specific performance is not guaranteed. For guaranteed specifications and the test conditions, see the Electrical Characteristics.

**Note 2:** Human body model,  $1.5\text{k}\Omega$  in series with  $100\text{pF}$ . Machine model,  $0\Omega$  in series with  $20\text{pF}$ .

**Note 3:** Shorting output to  $V^+$  will adversely affect reliability.

**Note 4:** Shorting output to  $V^-$  will adversely affect reliability.

**Note 5:** The maximum power dissipation is a function of  $T_{\text{J(MAX)}}$ ,  $\theta_{\text{JA}}$ , and  $T_{\text{A}}$ . The maximum allowable power dissipation at any ambient temperature is  $P_{\text{D}} = (T_{\text{J(MAX)}} - T_{\text{A}}) / \theta_{\text{JA}}$ . All numbers apply for packages soldered directly into a PC board.

**Note 6:** Typical Values represent the most likely parametric norm.

**Note 7:** All limits are guaranteed by testing or statistical analysis.

**Note 8:** Limits guaranteed by design.

**Note 9:**  $R_L$  is connected to mid-supply. The output voltage is set at  $200\text{mV}$  from the rails.  $V_O = \text{GND} + 0.2\text{V}$  and  $V_O = V^+ - 0.2\text{V}$

**Note 10:** For LMV772/LMV774, temperature limits apply to  $-40^\circ\text{C}$  to  $85^\circ\text{C}$ .

**Note 11:** For LMV772/LMV774, temperature limits apply to  $-40^\circ\text{C}$  to  $85^\circ\text{C}$ . If  $R_L$  is relaxed to  $10\text{k}\Omega$ , then for LMV772/LMV774 temperature limits apply to  $-40^\circ\text{C}$  to  $125^\circ\text{C}$ .

**Note 12:** Connected as voltage follower with  $2V_{\text{PP}}$  step input. Number specified is the slower of positive and negative slew rates.

**Note 13:** Electrical Table values apply only for factory testing conditions at the temperature indicated. Factory testing conditions result in very limited self-heating of the device such that  $T_J = T_A$ . No guarantee of parametric performance is indicated in the electrical tables under the conditions of internal self-heating where  $T_J > T_A$ . Absolute Maximum Rating indicated junction temperature limits beyond which the device may be permanently degraded, either mechanically or electrically.

**Note 14:** Continuous operation of the device with an output short circuit current larger than  $35\text{mA}$  may cause permanent damage to the device.

## Ordering Information

Package	Part Number	Package Marking	Transport Media	NSC Drawing
SC70-5	LMV771MG	A75	1k Units Tape and Reel	MAA05A
	LMV771MGX		3k Units Tape and Reel	
8-Pin SOIC	LMV772MA	LMV772MA	95 Units/Rail	M08A
	LMV772MAX		2.5k Units Tape and Reel	
8-Pin MSOP	LMV772MM	A91A	1k Units Tape and Reel	MUA08A
	LMV772MMX		3.5k Units Tape and Reel	
14-Pin TSSOP	LMV774MT	LMV774MT	95 Units/Rail	MTC14
	LMV774MTX		2.5k Units Tape and Reel	

## Connection Diagrams

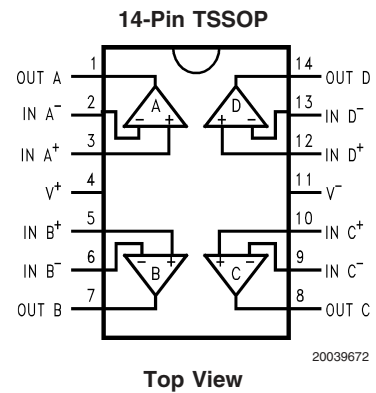
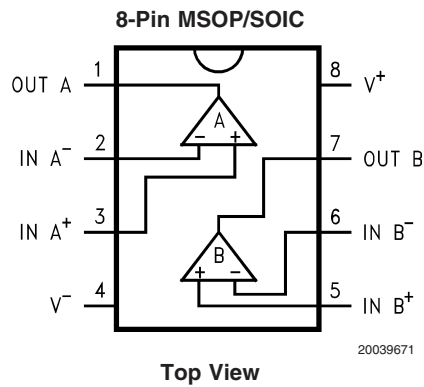
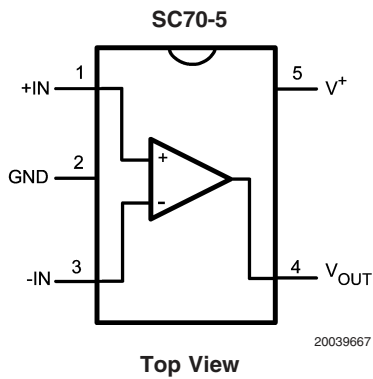

# Typical Performance Characteristics

**$V_{OS}$  vs.  $V_{CM}$  Over Temperature**

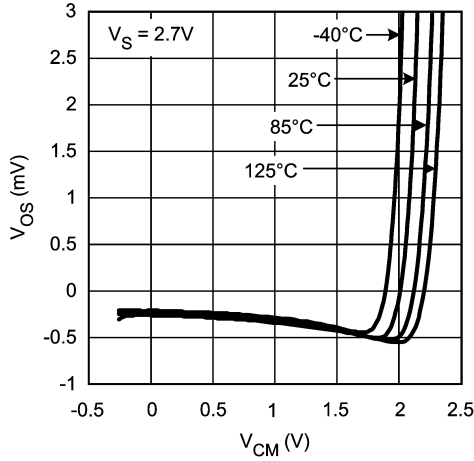

20039627

**$V_{OS}$  vs.  $V_{CM}$  Over Temperature**

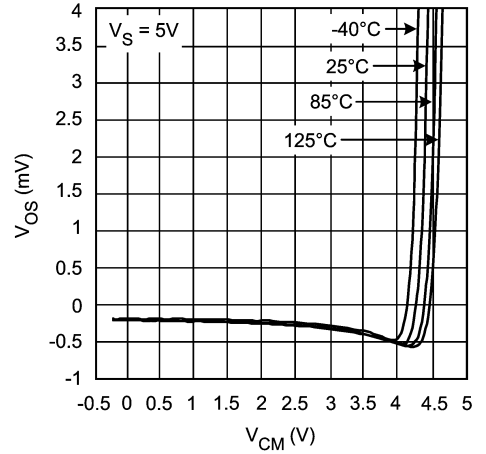

20039626

**Output Swing vs.  $V_S$**

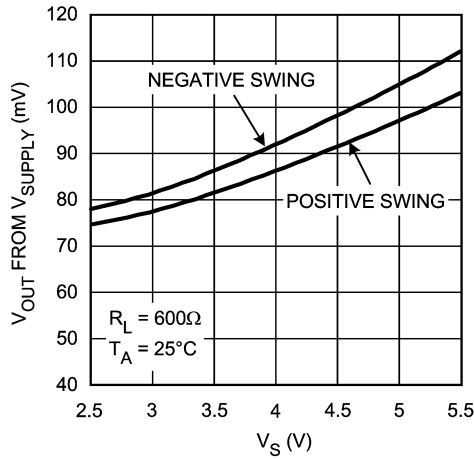

20039625

**Output Swing vs.  $V_S$**

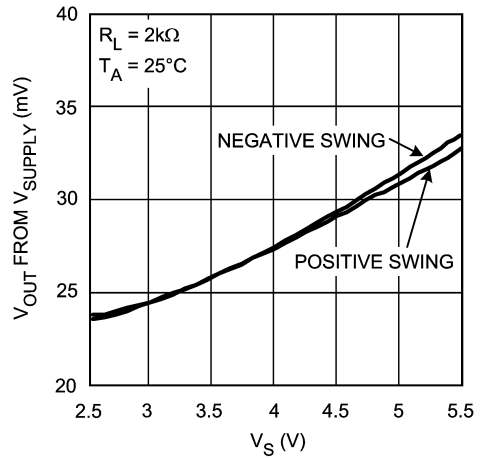

20039624

**Output Swing vs.  $V_S$**

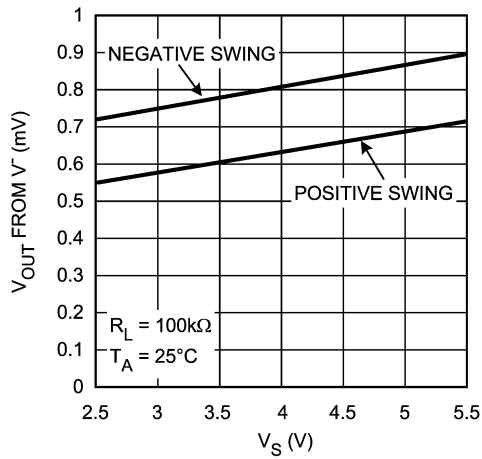

20039623

**$I_S$  vs.  $V_S$  Over Temperature**

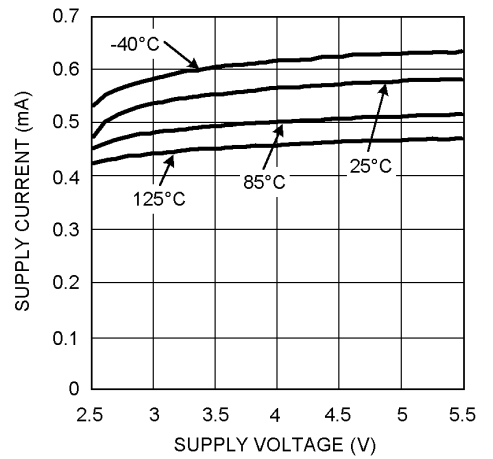

20039630

Typical Performance Characteristics (Continued)

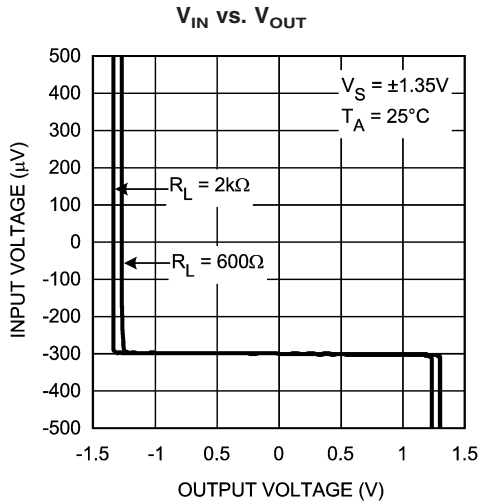

20039628

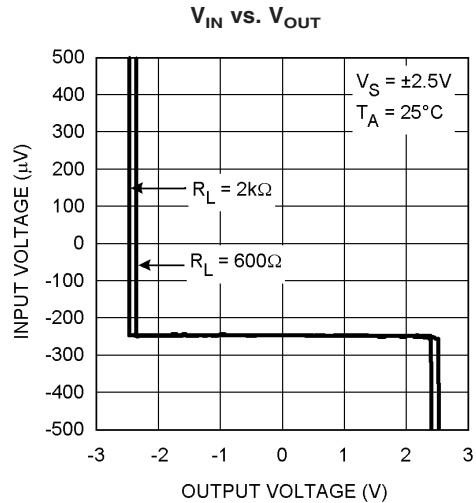

20039629

Sourcing Current vs. V<sub>OUT</sub> (Note 14)

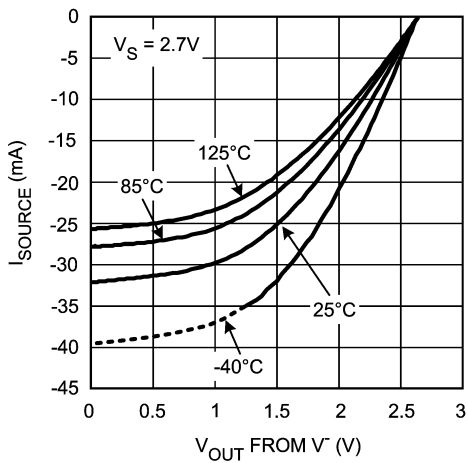

20039631

Sourcing Current vs. V<sub>OUT</sub> (Note 14)

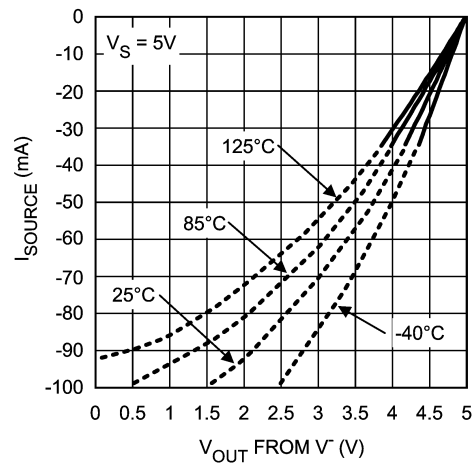

20039664

Sinking Current vs. V<sub>OUT</sub> (Note 14)

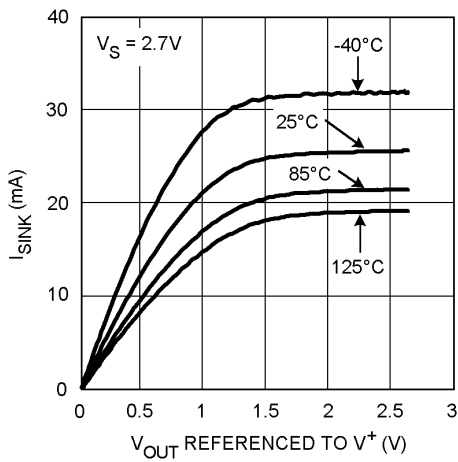

20039632

Sinking Current vs. V<sub>OUT</sub> (Note 14)

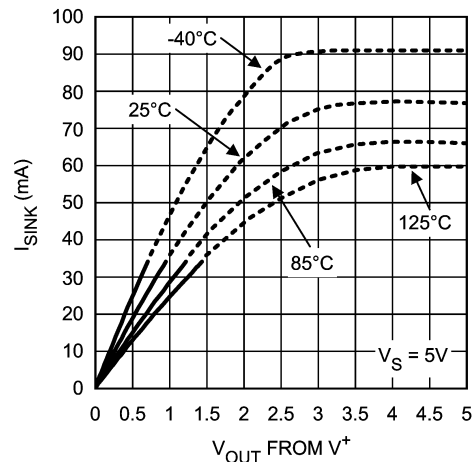

20039663

# Typical Performance Characteristics (Continued)

**Input Voltage Noise vs. Frequency**

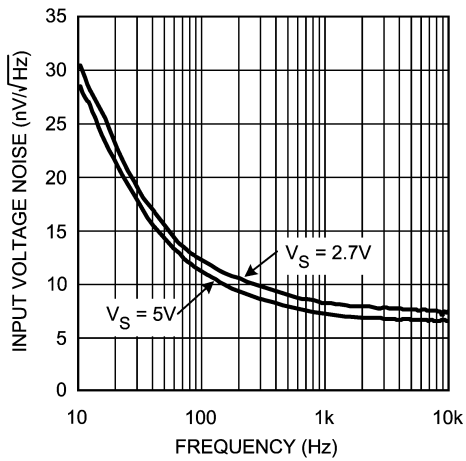

20039608

**Input Bias Current Over Temperature**

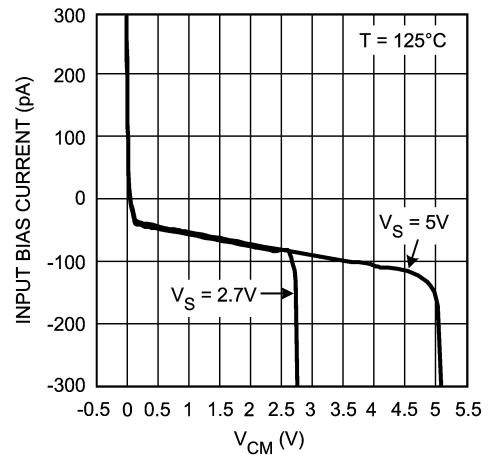

20039635

**Input Bias Current Over Temperature**

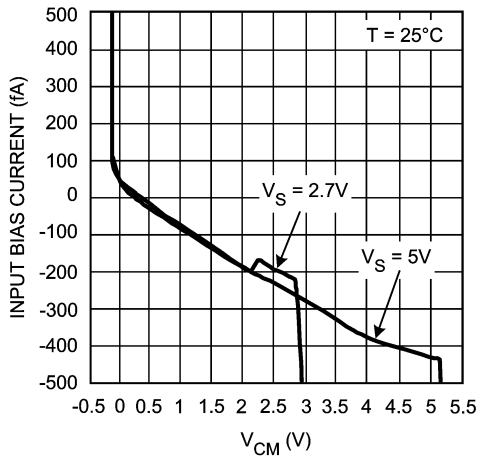

20039634

**Input Bias Current Over Temperature**

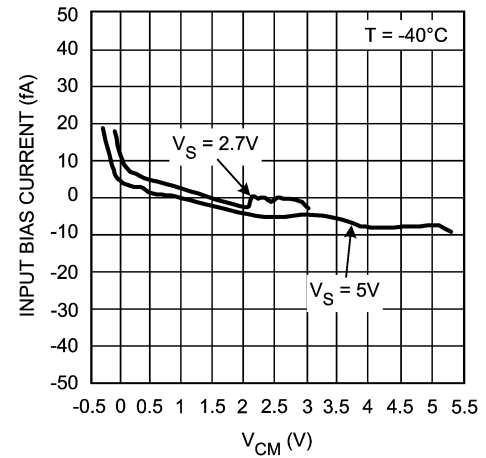

20039633

**THD+N vs. Frequency**

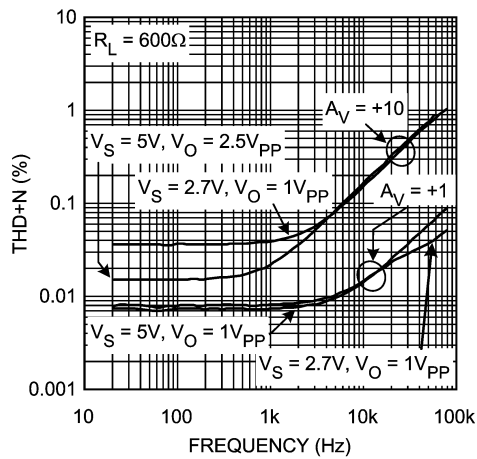

20039607

**THD+N vs. VOUT**

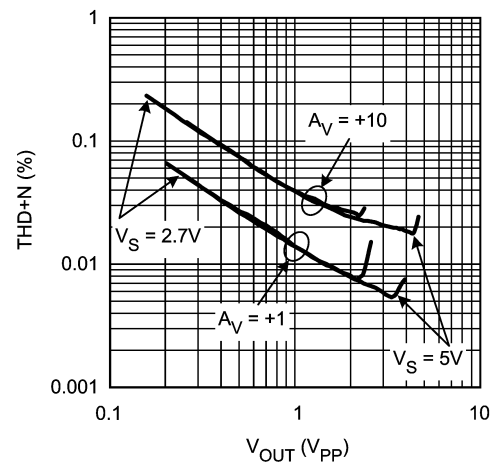

20039666



# Typical Performance Characteristics (Continued)

**Slew Rate vs. Supply Voltage**

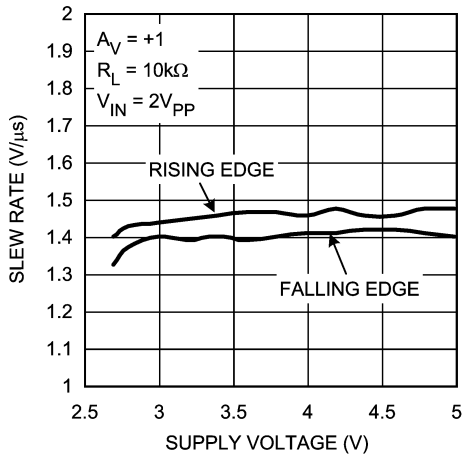

**Open Loop Frequency Response Over Temperature**

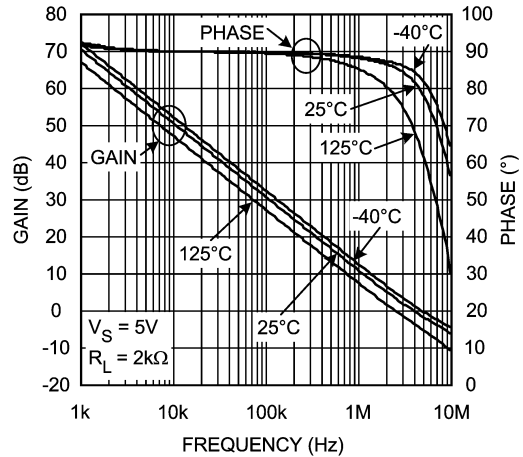

**Open Loop Frequency Response**

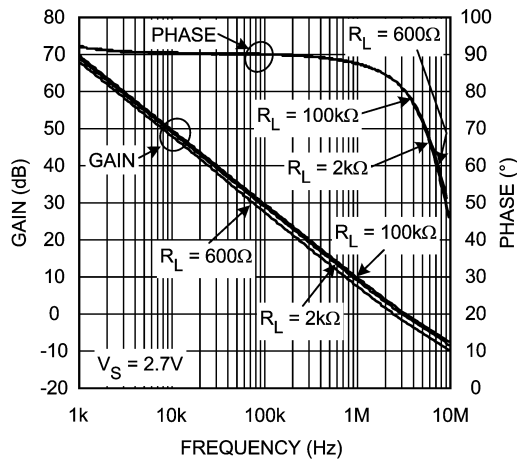

**Open Loop Frequency Response**

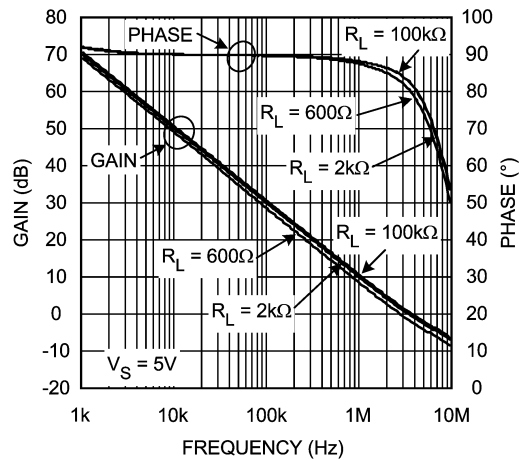

**Open Loop Gain & Phase with Cap. Loading**

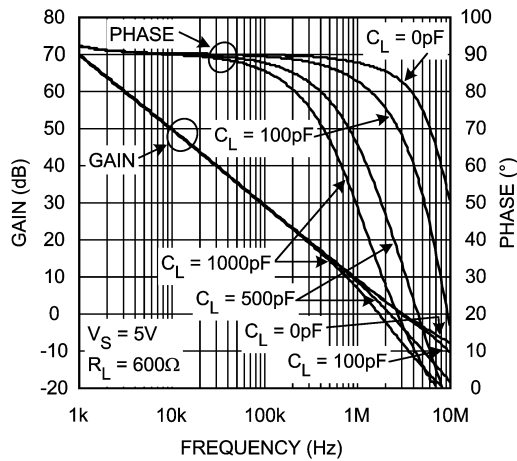

**Open Loop Gain & Phase with Cap. Loading**

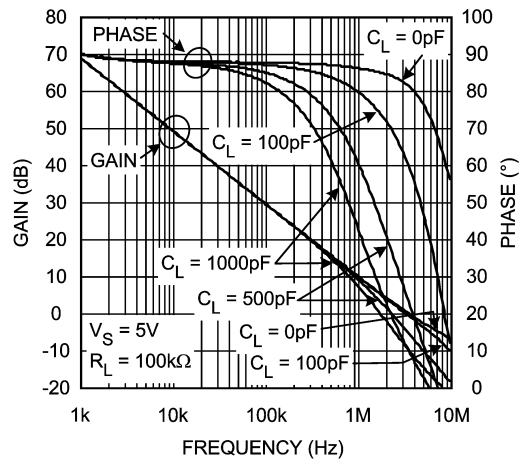

# Typical Performance Characteristics (Continued)

Non-Inverting Small Signal Pulse Response

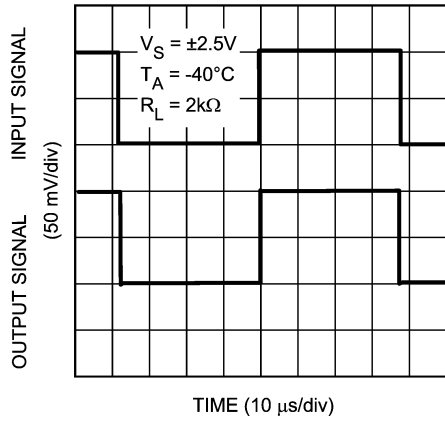

20039617

Non-Inverting Large Signal Pulse Response

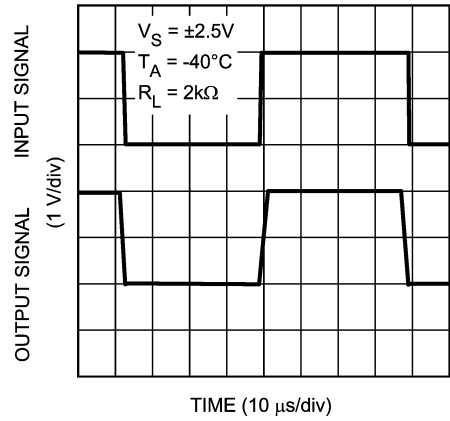

20039611

Non-Inverting Small Signal Pulse Response

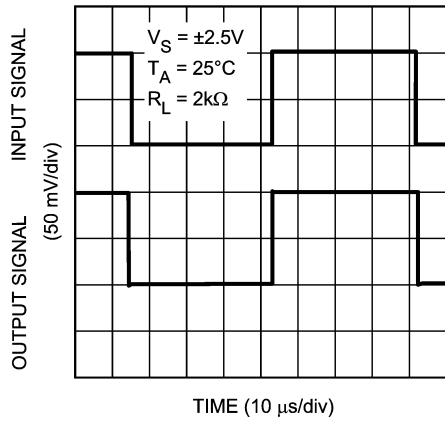

20039616

Non-Inverting Large Signal Pulse Response

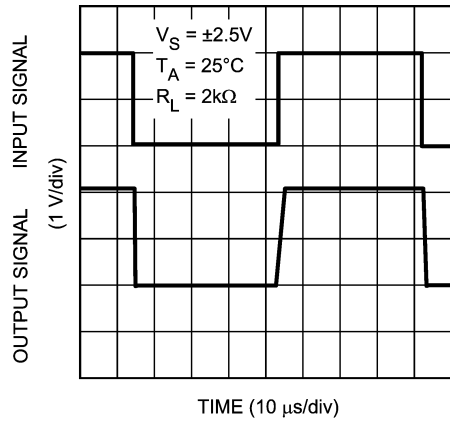

20039610

Non-Inverting Small Signal Pulse Response

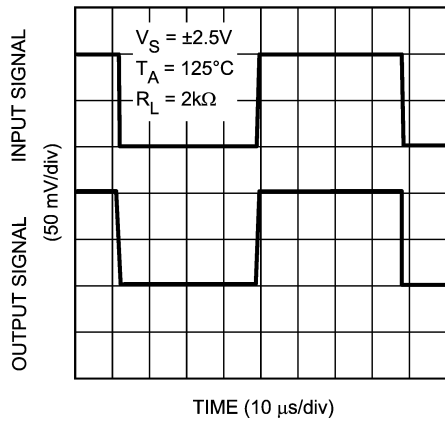

20039615

Non-Inverting Large Signal Pulse Response

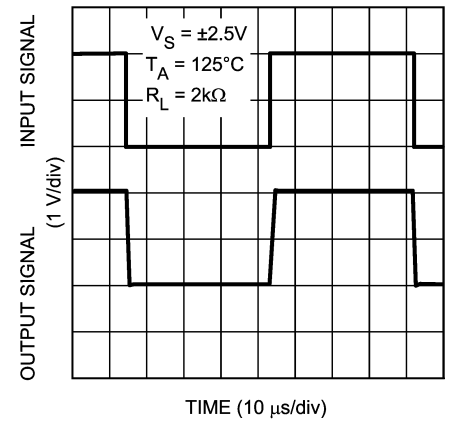

20039609

# Typical Performance Characteristics (Continued)

**Inverting Small Signal Pulse Response**

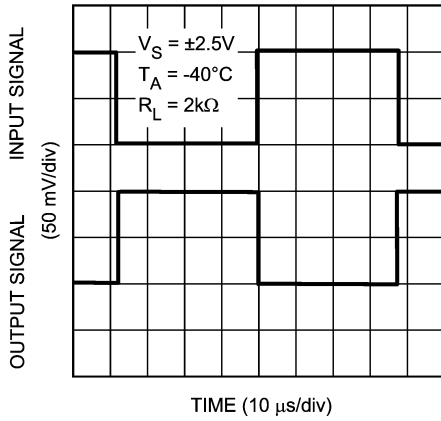

20039619

**Inverting Large Signal Pulse Response**

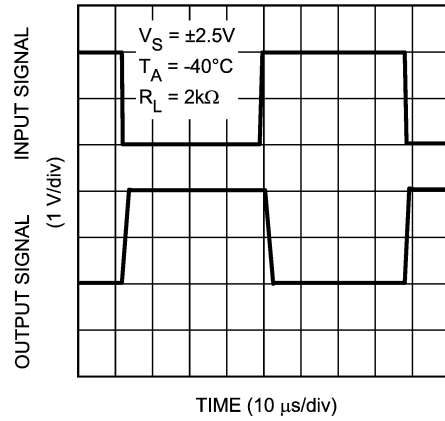

20039614

**Inverting Small Signal Pulse Response**

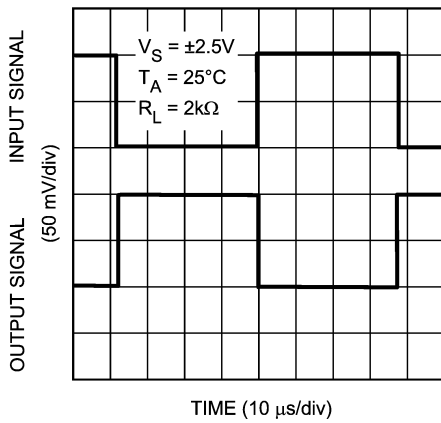

20039620

**Inverting Large Signal Pulse Response**

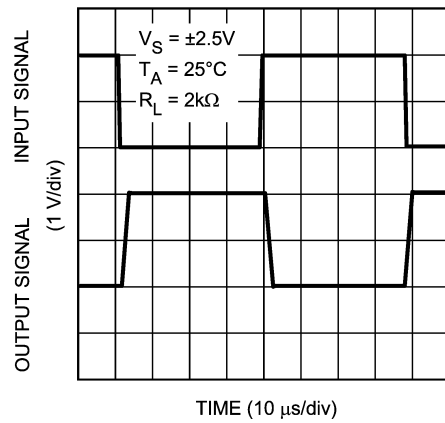

20039613

**Inverting Small Signal Pulse Response**

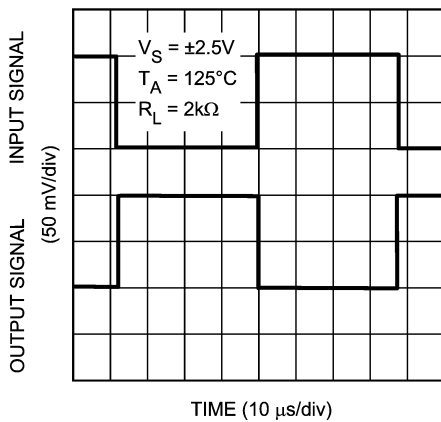

20039618

**Inverting Large Signal Pulse Response**

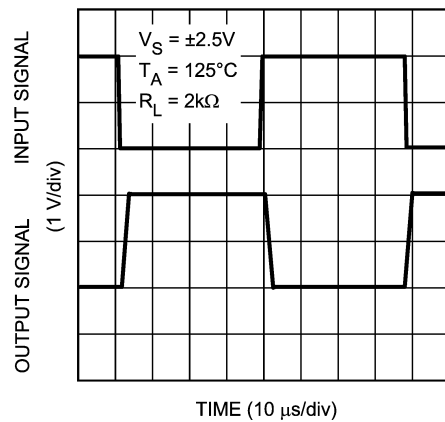

20039612

# Typical Performance Characteristics (Continued)

Stability vs.  $V_{CM}$

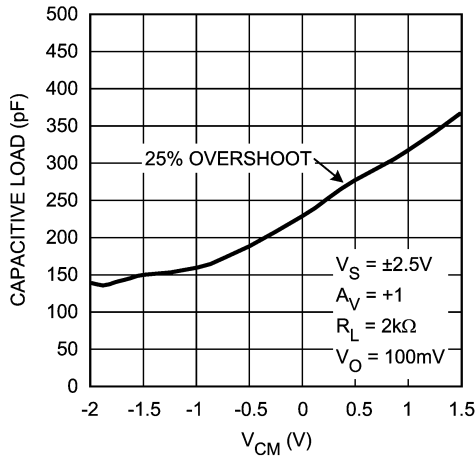

20039621

Stability vs.  $V_{CM}$

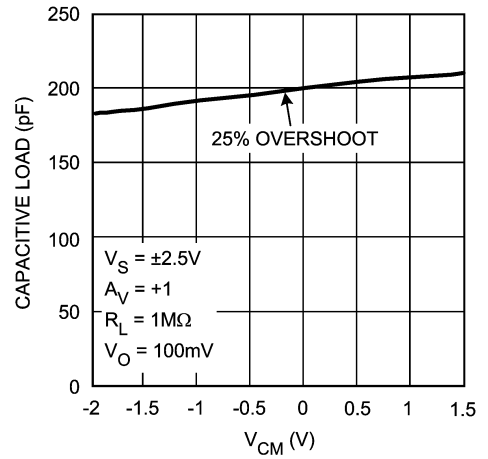

20039622

PSRR vs. Frequency

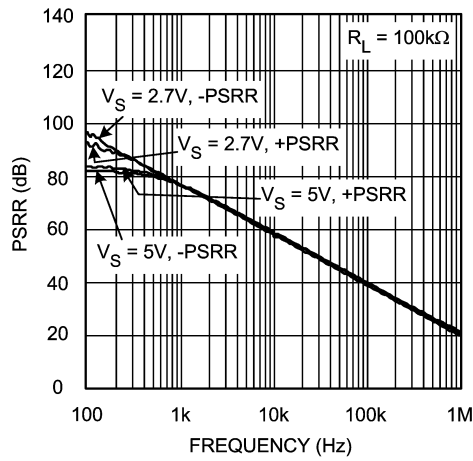

20039668

CMRR vs. Frequency

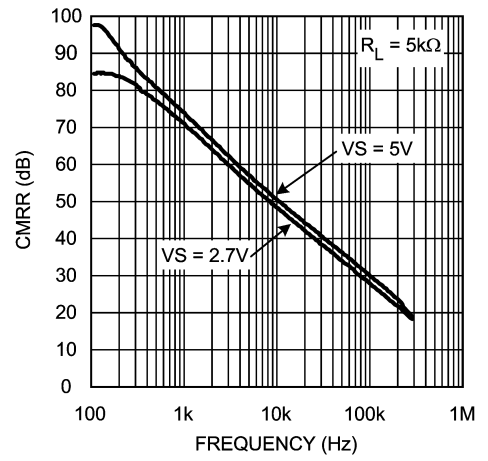

20039665

Crosstalk Rejection vs. Frequency

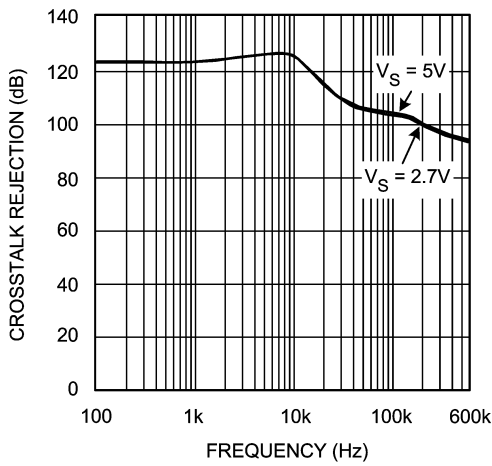

20039694

## Application Note

### LMV771/LMV772/LMV774

The LMV771/LMV772/LMV774 is a family of precision amplifiers with very low noise and ultra low offset voltage. LMV771/LMV772/LMV774's extended temperature range of  $-40^{\circ}\text{C}$  to  $125^{\circ}\text{C}$  enables the user to design this family of products in a variety of applications including automotive.

LMV771 has a maximum offset voltage of 1mV over the extended temperature range. This makes LMV771 ideal for applications where precision is of importance.

LMV772/LMV774 have a maximum offset voltage of 1mV at room temperature and 1.2mV over the extended temperature range of  $-40^{\circ}\text{C}$  to  $125^{\circ}\text{C}$ . Care must be given when LMV772/LMV774 are designed in applications with heavy loads under extreme temperature conditions. As indicated in the DC tables, the LMV772/LMV774's gain and output swing may be reduced at temperatures between  $85^{\circ}\text{C}$  and  $125^{\circ}\text{C}$  with loads heavier than  $2\text{k}\Omega$ .

### INSTRUMENTATION AMPLIFIER

Measurement of very small signals with an amplifier requires close attention to the input impedance of the amplifier, gain of the overall signal on the inputs, and the gain on each input since we are only interested in the difference of the two inputs and the common signal is considered noise. A classic solution is an instrumentation amplifier. Instrumentation amplifiers have a finite, accurate, and stable gain. Also they have extremely high input impedances and very low output impedances. Finally they have an extremely high CMRR so that the amplifier can only respond to the differential signal. A typical instrumentation amplifier is shown in *Figure 1*.

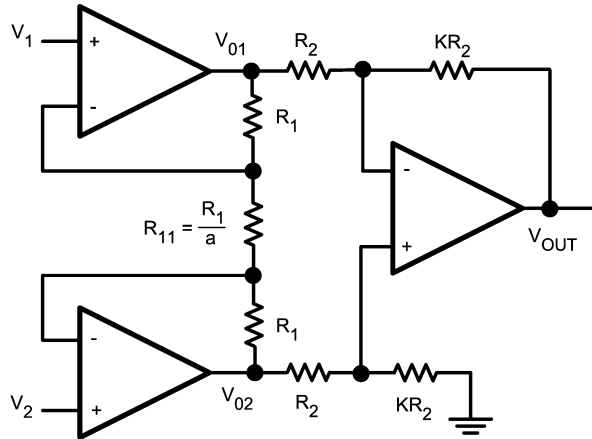

20039636

FIGURE 1.

There are two stages in this amplifier. The last stage, output stage, is a differential amplifier. In an ideal case the two amplifiers of the first stage, input stage, would be set up as buffers to isolate the inputs. However they cannot be connected as followers because of real amplifiers mismatch. That is why there is a balancing resistor between the two. The product of the two stages of the gain will give the gain of the instrumentation amplifier. Ideally, the CMRR should be infinity. However the output stage has a small non-zero common mode gain which results from resistor mismatch.

In the input stage of the circuit, current is the same across all resistors. This is due to the high input impedance and low input bias current of the LMV771. With the node equations we have:

$$\text{GIVEN: } I_{R_1} = I_{R_{11}} \quad (1)$$

By Ohm's Law:

$$\begin{aligned} V_{O1} - V_{O2} &= (2R_1 + R_{11}) I_{R_{11}} \\ &= (2a + 1) R_{11} \cdot I_{R_{11}} \\ &= (2a + 1) V_{R_{11}} \end{aligned} \quad (2)$$

However:

$$V_{R_{11}} = V_1 - V_2 \quad (3)$$

So we have:

$$V_{O1} - V_{O2} = (2a + 1) (V_1 - V_2) \quad (4)$$

Now looking at the output of the instrumentation amplifier:

$$\begin{aligned} V_O &= \frac{KR_2}{R_2} (V_{O2} - V_{O1}) \\ &= -K (V_{O1} - V_{O2}) \end{aligned} \quad (5)$$

Substituting from equation 4:

$$V_O = -K (2a + 1) (V_1 - V_2) \quad (6)$$

This shows the gain of the instrumentation amplifier to be:

$$-K(2a+1)$$

Typical values for this circuit can be obtained by setting:  $a = 12$  and  $K = 4$ . This results in an overall gain of  $-100$ .

*Figure 2* shows typical CMRR characteristics of this Instrumentation amplifier over frequency. Three LMV771 amplifiers are used along with 1% resistors to minimize resistor mismatch. Resistors used to build the circuit are:  $R_1 = 21.6\text{k}\Omega$ ,  $R_{11} = 1.8\text{k}\Omega$ ,  $R_2 = 2.5\text{k}\Omega$  with  $K = 40$  and  $a = 12$ . This results in an overall gain of  $-1000$ ,  $-K(2a+1) = -1000$ .

## Application Note (Continued)

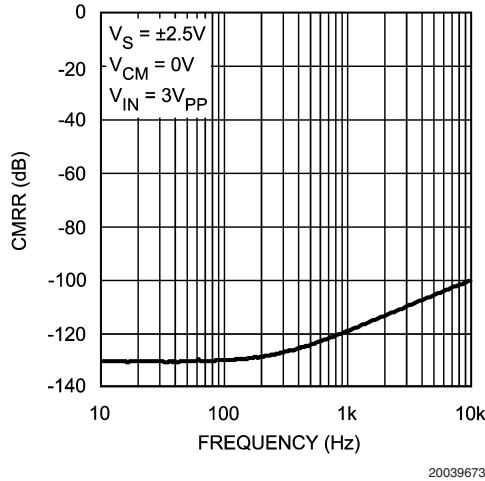

FIGURE 2. CMRR vs. Frequency

### ACTIVE FILTER

Active Filters are circuits with amplifiers, resistors, and capacitors. The use of amplifiers instead of inductors, which are used in passive filters, enhances the circuit performance while reducing the size and complexity of the filter.

The simplest active filters are designed using an inverting op amp configuration where at least one reactive element has been added to the configuration. This means that the op amp will provide "frequency-dependent" amplification, since reactive elements are frequency dependent devices.

### LOW PASS FILTER

The following shows a very simple low pass filter.

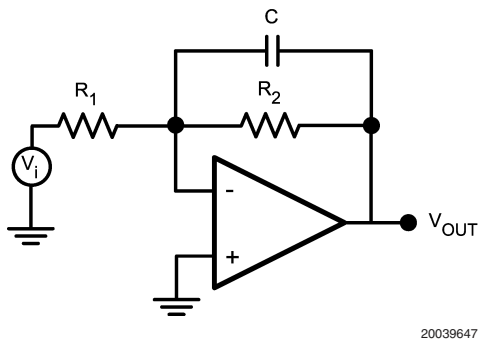

FIGURE 3.

The transfer function can be expressed as follows:

By KCL:

$$\frac{-V_i}{R_1} - \frac{V_O}{\left[ \frac{1}{j\omega C} \right]} - \frac{V_O}{R_2} = 0$$

(7)

Simplifying this further results in:

$$V_O = \frac{-R_2}{R_1} \left[ \frac{1}{j\omega C R_2 + 1} \right] V_i$$

(8)

or

$$\frac{V_O}{V_i} = \frac{-R_2}{R_1} \left[ \frac{1}{j\omega C R_2 + 1} \right]$$

(9)

Now, substituting  $\omega=2\pi f$ , so that the calculations are in f(Hz) and not  $\omega$ (rad/s), and setting the DC gain  $\left[ \frac{-R_2}{R_1} = H_O \right]$  and

$$H = \frac{V_O}{V_i}$$

$$H = H_O \left[ \frac{1}{j2\pi f C R_2 + 1} \right]$$

(10)

$$\text{Set: } f_O = \frac{1}{2\pi R_2 C}$$

$$H = H_O \left[ \frac{1}{1 + j(f/f_O)} \right]$$

(11)

Low pass filters are known as lossy integrators because they only behave as an integrator at higher frequencies. Just by looking at the transfer function one can predict the general form of the bode plot. When the  $f/f_O$  ratio is small, the capacitor is in effect an open circuit and the amplifier behaves at a set DC gain. Starting at  $f_O$ , -3dB corner, the capacitor will have the dominant impedance and hence the circuit will behave as an integrator and the signal will be attenuated and eventually cut. The bode plot for this filter is shown in the following picture:

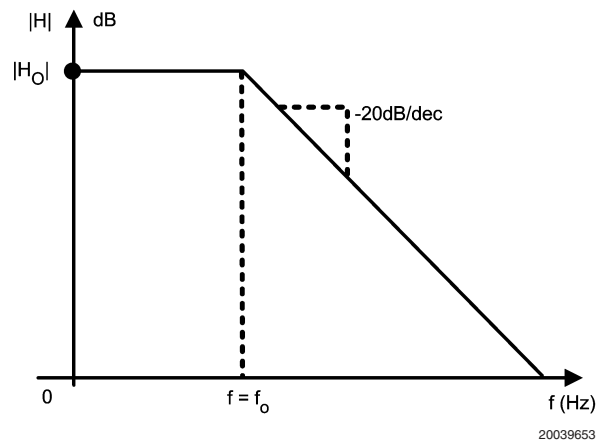
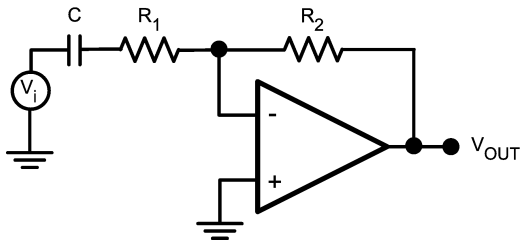

FIGURE 4.

## Application Note (Continued)

### HIGH PASS FILTER

In a similar approach, one can derive the transfer function of a high pass filter. A typical first order high pass filter is shown below:



20039654

FIGURE 5.

Writing the KCL for this circuit :

( $V_1$  denotes the voltage between C and  $R_1$ )

$$\frac{V_1 - V_1}{j\omega C} = \frac{V_1 - V^-}{R_1} \quad (12)$$

$$\frac{V^- + V_1}{R_1} = \frac{V^- + V_O}{R_2} \quad (13)$$

Solving these two equations to find the transfer function and using:

$$f_O = \frac{1}{2\pi R_2 C}$$

(high frequency gain)  $H_O = \frac{-R_2}{R_1}$  and  $H = \frac{V_O}{V_1}$   
Which results:

$$H = H_O \frac{j(f/f_O)}{1 + j(f/f_O)} \quad (14)$$

Looking at the transfer function, it is clear that when  $f/f_O$  is small, the capacitor is open and hence no signal is getting in to the amplifier. As the frequency increases the amplifier starts operating. At  $f = f_O$  the capacitor behaves like a short circuit and the amplifier will have a constant, high frequency, gain of  $H_O$ . The bode plot of the transfer function follows:

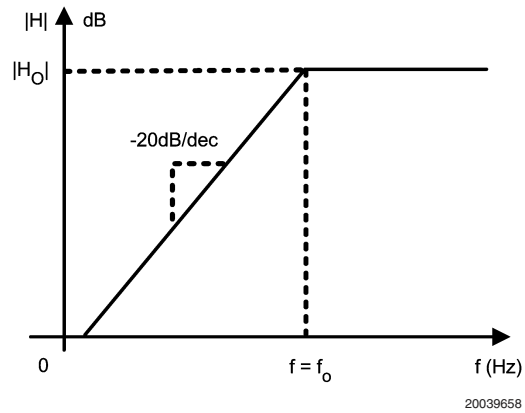

20039658

FIGURE 6.

### BAND PASS FILTER

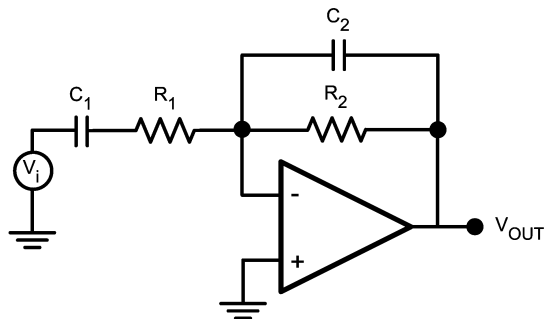

20039660

FIGURE 7.

Combining a low pass filter and a high pass filter will generate a band pass filter. In this network the input impedance forms the high pass filter while the feedback impedance forms the low pass filter. Choosing the corner frequencies so that  $f_1 < f_2$ , then all the frequencies in between,  $f_1 \leq f \leq f_2$ , will pass through the filter while frequencies below  $f_1$  and above  $f_2$  will be cut off.

The transfer function can be easily calculated using the same methodology as before.

$$H = H_O \frac{j(f/f_1)}{[1 + j(f/f_1)] [1 + j(f/f_2)]} \quad (15)$$

Where

$$f_1 = \frac{1}{2\pi R_1 C_1}$$

$$f_2 = \frac{1}{2\pi R_2 C_2}$$

$$H_O = \frac{-R_2}{R_1}$$

The transfer function is presented in the following figure.

## Application Note (Continued)

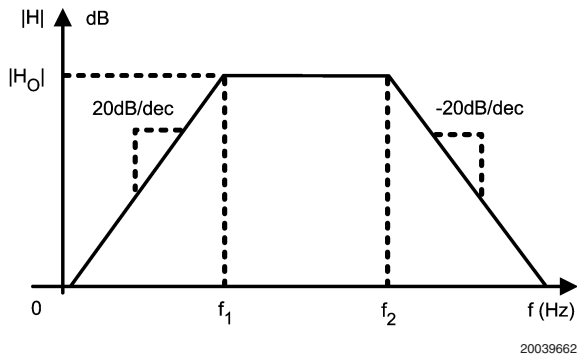
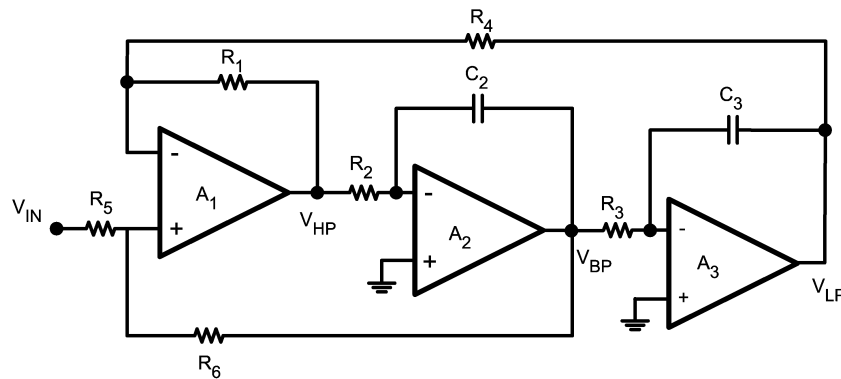

FIGURE 8.

## STATE VARIABLE ACTIVE FILTER

State variable active filters are circuits that can simultaneously represent high pass, band pass, and low pass filters. The state variable active filter uses three separate amplifiers to achieve this task. A typical state variable active filter is shown in Figure 9. The first amplifier in the circuit is connected as a gain stage. The second and third amplifiers are connected as integrators, which means they behave as low pass filters. The feedback path from the output of the third amplifier to the first amplifier enables this low frequency signal to be fed back with a finite and fairly low closed loop gain. This is while the high frequency signal on the input is still gained up by the open loop gain of the 1st amplifier. This makes the first amplifier a high pass filter. The high pass signal is then fed in to a low pass filter. The outcome is a band pass signal, meaning the second amplifier is a band pass filter. This signal is then fed into the third amplifiers input and so the third amplifier behaves as a simple low pass filter.



20039674

FIGURE 9.

The transfer function of each filter needs to be calculated. The derivations will be more trivial if each stage of the filter is shown on its own.

The three components are:

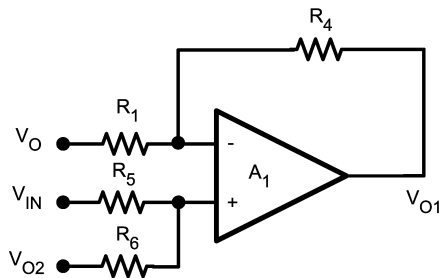

20039680

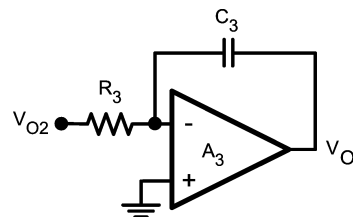
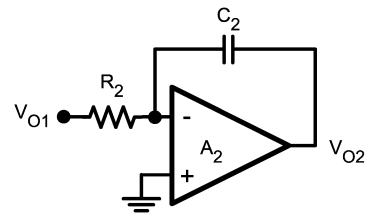

20039681

For A<sub>1</sub>, the relationship between input and output is:

$$V_{O1} = \frac{-R_4}{R_1} V_0 + \left[ \frac{R_6}{R_5 + R_6} \right] \left[ \frac{R_1 + R_4}{R_1} \right] V_{IN} + \left[ \frac{R_5}{R_5 + R_6} \right] \left[ \frac{R_1 + R_4}{R_1} \right] V_{O2}$$



## Application Note (Continued)

This relationship depends on the output of all the filters. The input-output relationship for  $A_2$  can be expressed as:

$$V_{O2} = \frac{-1}{s C_2 R_2} V_{O1}$$

And finally this relationship for  $A_3$  is as follows:

$$V_O = \frac{-1}{s C_3 R_3} V_{O2}$$

Re-arranging these equations, one can find the relationship between  $V_O$  and  $V_{IN}$  (transfer function of the lowpass filter),  $V_{O1}$  and  $V_{IN}$  (transfer function of the highpass filter), and  $V_{O2}$  and  $V_{IN}$  (transfer function of the bandpass filter) These relationships are as follows:

### Lowpass filter

$$\frac{V_O}{V_{IN}} = \frac{\left[ \frac{R_1 + R_4}{R_1} \right] \left[ \frac{R_6}{R_5 + R_6} \right] \left[ \frac{1}{C_2 C_3 R_2 R_3} \right]}{s^2 + s \left[ \frac{1}{C_2 R_2} \right] \left[ \frac{R_5}{R_5 + R_6} \right] \left[ \frac{R_1 + R_4}{R_1} \right] + \left[ \frac{1}{C_2 C_3 R_2 R_3} \right]}$$

### Highpass filter

$$\frac{V_{O1}}{V_{IN}} = \frac{s^2 \left[ \frac{R_1 + R_4}{R_1} \right] \left[ \frac{R_6}{R_5 + R_6} \right]}{s^2 + s \left[ \frac{1}{C_2 R_2} \right] \left[ \frac{R_5}{R_5 + R_6} \right] \left[ \frac{R_1 + R_4}{R_1} \right] + \left[ \frac{1}{C_2 C_3 R_2 R_3} \right]}$$

### Bandpass Filter

$$\frac{V_{O2}}{V_{IN}} = \frac{s \left[ \frac{1}{C_2 R_2} \right] \left[ \frac{R_1 + R_4}{R_1} \right] \left[ \frac{R_6}{R_5 + R_6} \right]}{s^2 + s \left[ \frac{1}{C_2 R_2} \right] \left[ \frac{R_5}{R_5 + R_6} \right] \left[ \frac{R_1 + R_4}{R_1} \right] + \left[ \frac{1}{C_2 C_3 R_2 R_3} \right]}$$

The center frequency and quality factor for all of these filters is the same. The values can be calculated in the following manner:

$$\omega_c = \sqrt{\frac{1}{C_2 C_3 R_2 R_3}}$$

and

$$Q = \sqrt{\frac{C_2 R_2}{C_3 R_3} \left[ \frac{R_5 + R_6}{R_6} \right] \left[ \frac{R_1}{R_1 + R_4} \right]}$$

A design example is shown here:

Designing a bandpass filter with center frequency of 10kHz and Quality factor of 5.5

To do this, first consider the quality factor. It is best to pick convenient values for the capacitors.  $C_2 = C_3 = 1000\text{pF}$ . Also, choose  $R_1 = R_4 = 30\text{k}\Omega$ . Now Values of  $R_5$  and  $R_6$  need to be calculated. With the chosen values for the capacitors and resistors, Q reduces to:

$$Q = \frac{11}{2} = \frac{1}{2} \left[ \frac{R_5 + R_6}{R_6} \right]$$

or

$$\begin{aligned} R_5 &= 10R_6 \\ R_6 &= 1.5\text{k}\Omega \\ R_5 &= 15\text{k}\Omega \end{aligned}$$

Also, for  $f = 10\text{kHz}$ , value of center frequency is  $\omega_c = 2\pi f = 62.8\text{kHz}$ .

Using the expressions above, the appropriate resistor values will be  $R_2 = R_3 = 16\text{k}\Omega$ .

The following graphs show the transfer function of each of the filters. The DC gain of this circuit is:

$$\text{DC GAIN} = \left[ \frac{R_1 + R_4}{R_1} \right] \left[ \frac{R_6}{R_5 + R_6} \right] = -14.8 \text{ dB}$$

20039690

The following graphics show the frequency response of each of the stages when using LMV774 as the amplifier:

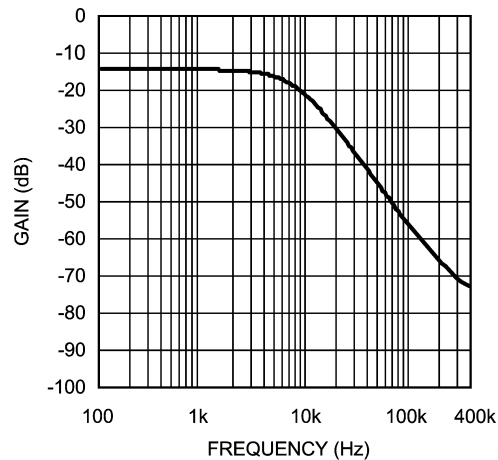

20039691

FIGURE 10. Lowpass Filter Frequency Response

**Application Note** (Continued)

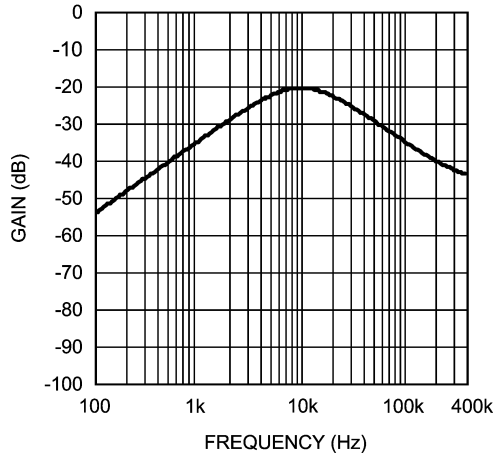

20039692

**FIGURE 11. Bandpass Filter Frequency Response**

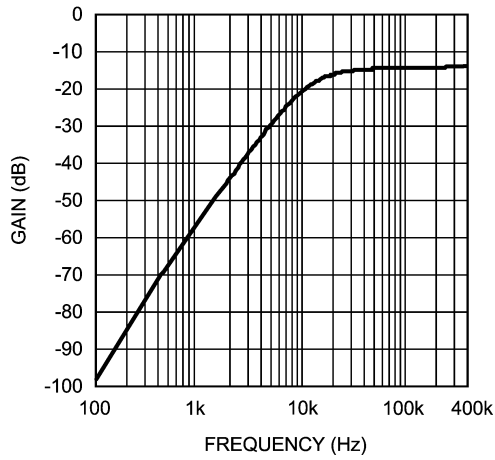

20039693

**FIGURE 12. Highpass Filter Frequency Response**

# Physical Dimensions inches (millimeters)

unless otherwise noted

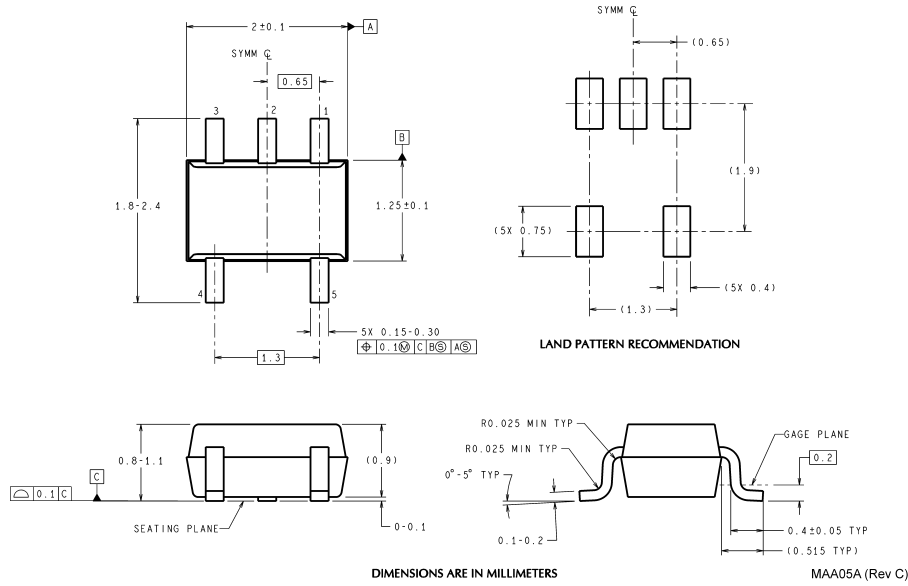

**SC70-5**  
NS Package Number MAA05A

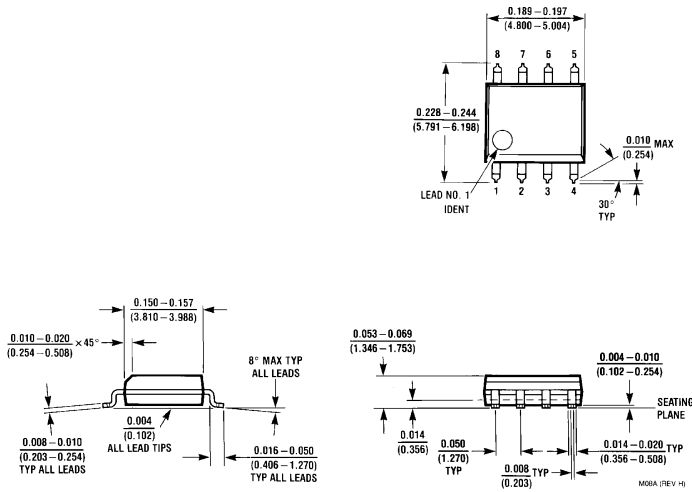

**8-Pin SOIC**  
NS Package Number M08A

**Physical Dimensions** inches (millimeters) unless otherwise noted (Continued)

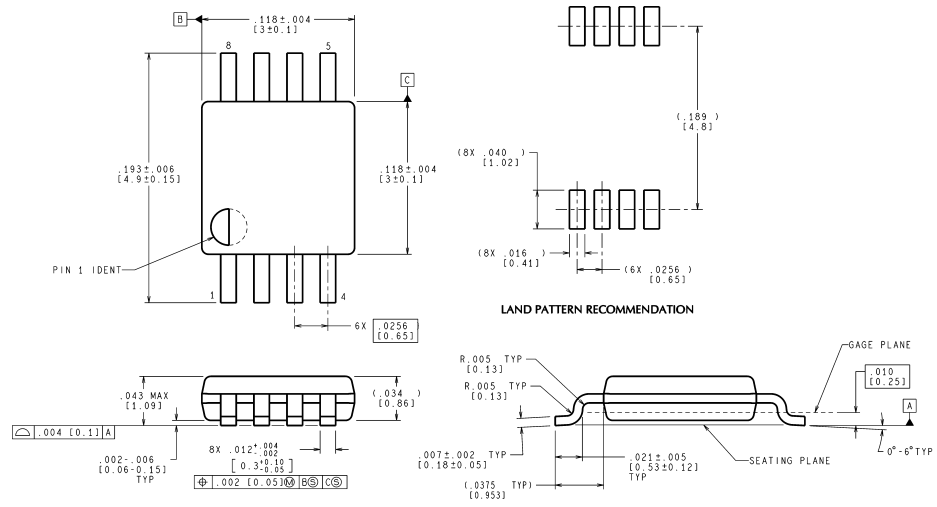

CONTROLLING DIMENSION IS INCH  
VALUES IN [ ] ARE MILLIMETERS  
MUA08A (Rev E)

**8-Pin MSOP**  
**NS Package Number MUA08A**

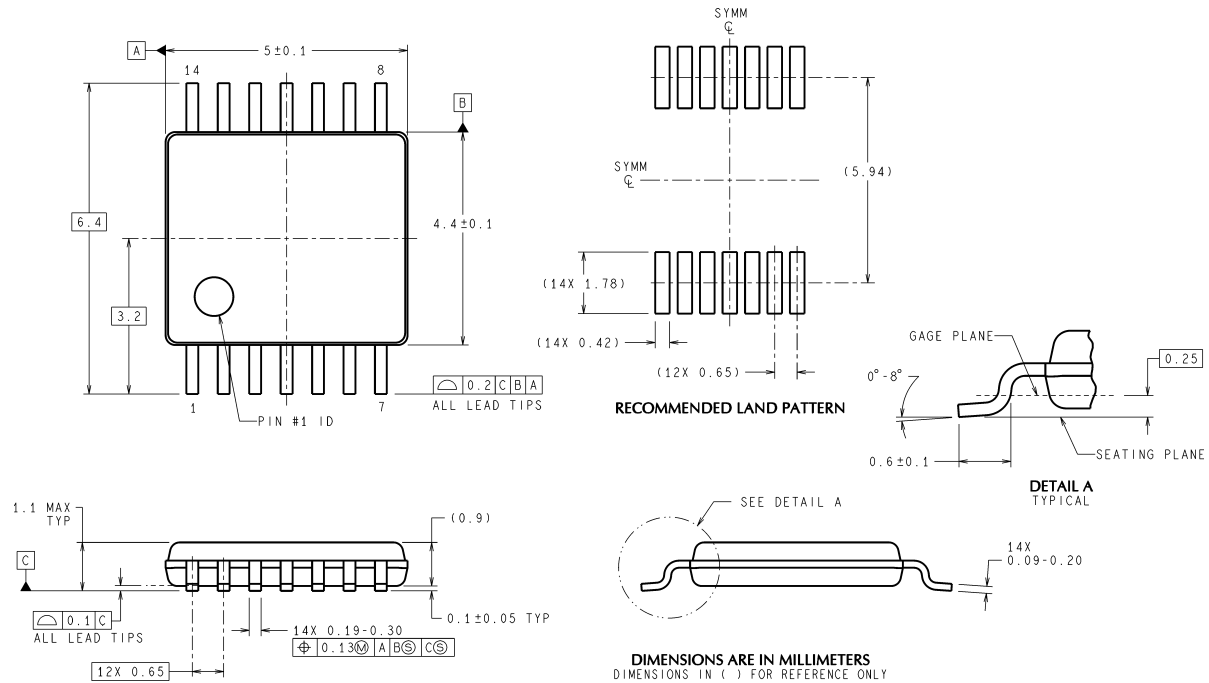

DIMENSIONS ARE IN MILLIMETERS  
DIMENSIONS IN ( ) FOR REFERENCE ONLY  
MTC14 (Rev D)

**14-Pin TSSOP**  
**NS Package Number MTC14**

## Notes

### LIFE SUPPORT POLICY

NATIONAL'S PRODUCTS ARE NOT AUTHORIZED FOR USE AS CRITICAL COMPONENTS IN LIFE SUPPORT DEVICES OR SYSTEMS WITHOUT THE EXPRESS WRITTEN APPROVAL OF THE PRESIDENT AND GENERAL COUNSEL OF NATIONAL SEMICONDUCTOR CORPORATION. As used herein:

1. Life support devices or systems are devices or systems which, (a) are intended for surgical implant into the body, or (b) support or sustain life, and whose failure to perform when properly used in accordance with instructions for use provided in the labeling, can be reasonably expected to result in a significant injury to the user.
2. A critical component is any component of a life support device or system whose failure to perform can be reasonably expected to cause the failure of the life support device or system, or to affect its safety or effectiveness.

### BANNED SUBSTANCE COMPLIANCE

National Semiconductor certifies that the products and packing materials meet the provisions of the Customer Products Stewardship Specification (CSP-9-111C2) and the Banned Substances and Materials of Interest Specification (CSP-9-111S2) and contain no "Banned Substances" as defined in CSP-9-111S2.



**National Semiconductor**  
Americas Customer  
Support Center  
Email: [new.feedback@nsc.com](mailto:new.feedback@nsc.com)  
Tel: 1-800-272-9959

**National Semiconductor**  
Europe Customer Support Center  
Fax: +49 (0) 180-530 85 86  
Email: [europe.support@nsc.com](mailto:europe.support@nsc.com)  
Deutsch Tel: +49 (0) 69 9508 6208  
English Tel: +44 (0) 870 24 0 2171  
Français Tel: +33 (0) 1 41 91 8790

**National Semiconductor**  
Asia Pacific Customer  
Support Center  
Email: [ap.support@nsc.com](mailto:ap.support@nsc.com)

**National Semiconductor**  
Japan Customer Support Center  
Fax: 81-3-5639-7507  
Email: [jpn.feedback@nsc.com](mailto:jpn.feedback@nsc.com)  
Tel: 81-3-5639-7560

[www.national.com](http://www.national.com)