



## ●Absolute maximum ratings (Ta = 25°C)

Parameter		Symbol	Limits	Unit
Power supply voltage		V <sub>CC</sub>	7	V
		V <sub>M</sub>	16	
Power dissipation	BA6840BFS	P <sub>d</sub>	930*1	mW
	BA6840BFP-Y		1450*2	
	BA6840BFP		1700*3	
	BA6842BFS		1000*4	
Operating temperature		T <sub>opr</sub>	-20~+75	°C
Storage temperature		T <sub>stg</sub>	-55~+150	°C
Output current		I <sub>out</sub>	1300	mA

\*1 Reduced by 7.5 mW for each increase in Ta of 1°C over 25°C.

\*2 Reduced by 11.6 mW for each increase in Ta of 1°C over 25°C.

\*3 Reduced by 13.6 mW for each increase in Ta of 1°C over 25°C.

\*4 Reduced by 8.0 mW for each increase in Ta of 1°C over 25°C.

\*1~4 When mounted on a 90×50×1.6 mm glass epoxy board.

Should not exceed P<sub>d</sub> or ASO values.

## ●Recommended operating conditions

Parameter	Symbol	Min.	Typ.	Max.	Unit
Operating power supply voltage	V <sub>CC</sub>	4.25	—	5.50	V
	V <sub>M</sub>	3.0	—	15	V

●Electrical characteristics (unless otherwise noted,  $T_a = 25^\circ\text{C}$ ,  $V_{CC} = 5\text{V}$ ,  $V_M = 12\text{V}$ )

Parameter	Symbol	Min.	Typ.	Max.	Unit	Conditions
〈Overall〉						
Supply current 1	$I_{CC1}$	—		0.2	mA	Start / stop OFF
Supply current 2	$I_{CC2}$	—	3.6	6.0	mA	Start / stop ON inputs : H, M and L
〈Start / stop〉						
ON voltage	$V_{PSON}$	3.5	—	—	V	
OFF voltage	$V_{PSOFF}$	—	—	1.5	V	
〈Hall bias〉						
Hall bias voltage	$V_{HB}$	—	0.9	1.5	V	$I_{HB}=10\text{mA}$
〈Hall amplifier〉						
Input bias current	$I_{HA}$	—	0.25	1.0	$\mu\text{A}$	
Common-mode input voltage	$V_{HAR}$	1.5	—	4.0	V	
Minimum input level	$V_{INH}$	50	—	—	mV <sub>P-P</sub>	
〈Torque control〉						
Input voltage	$E_C$	1.0	—	4.0	V	
Offset voltage +	$E_{COFS+}$	20	50	80	mV	For $E_{CR}=2.5\text{V}$
Offset voltage -	$E_{COFS-}$	-80	-50	-20	mV	
Input current	$E_{CIN}$	—	0.5	2.0	$\mu\text{A}$	$E_C = E_{CR} = 2.5\text{V}$
Input/output gain	$G_{EC}$	0.41	0.51	0.61	A/V	$R_{NF} = 0.5\Omega$ , when measured at $E_C=2\text{points: } 1.5\text{V and } 2.0\text{V}$ $E_C=2\text{points: } 3.0\text{V and } 3.5\text{V}$
〈Output〉						
Output saturation high level voltage	$V_{OH}$	—	1.0	1.6	V	$I_O = -600\text{mA}$
Output saturation low level voltage	$V_{OL}$	—	0.4	0.9	V	$I_O = 600\text{mA}$
Torque limit current	$I_{TL}$	560	700	840	mA	$R_{NF} = 0.5\Omega$

©Not designed for radiation resistance

●Electrical characteristic curves

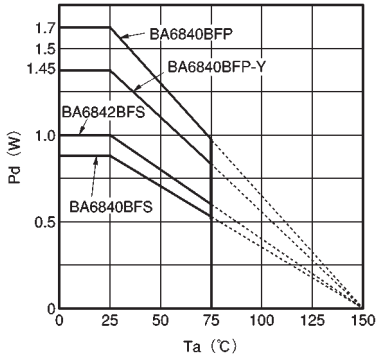

Fig.1 Power dissipation curves

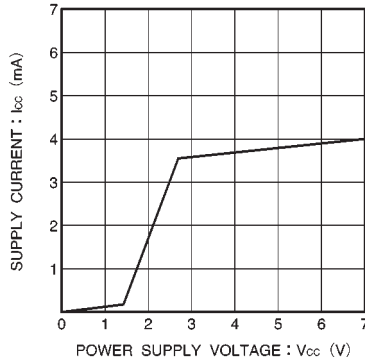

Fig.2 Supply current vs. power supply voltage

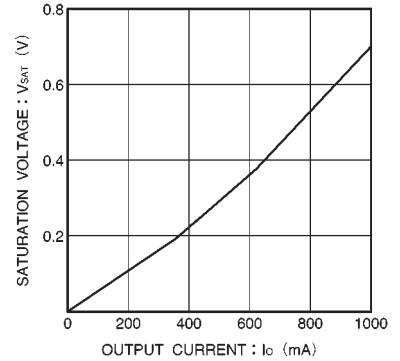

Fig.3 Low-level output saturation voltage vs. output current

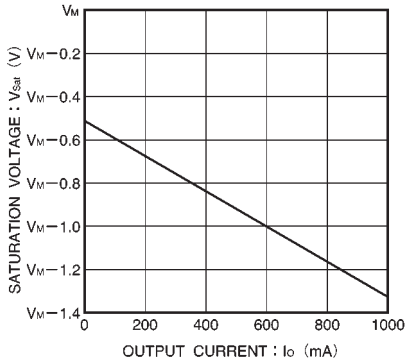

Fig.4 High-level output saturation voltage vs. output current

● Circuit operation

(1) Hall input ~ output

The 3-phase Hall signal is amplified in the hall amplifiers and sent to the matrix section, where the signal is further amplified and combined. After the signal is converted to a current in the amplitude control circuit, the current is supplied to the output driver, which then provides a motor drive current. The phases of the Hall input signal, output voltage, and output current are shown in Fig. 5.

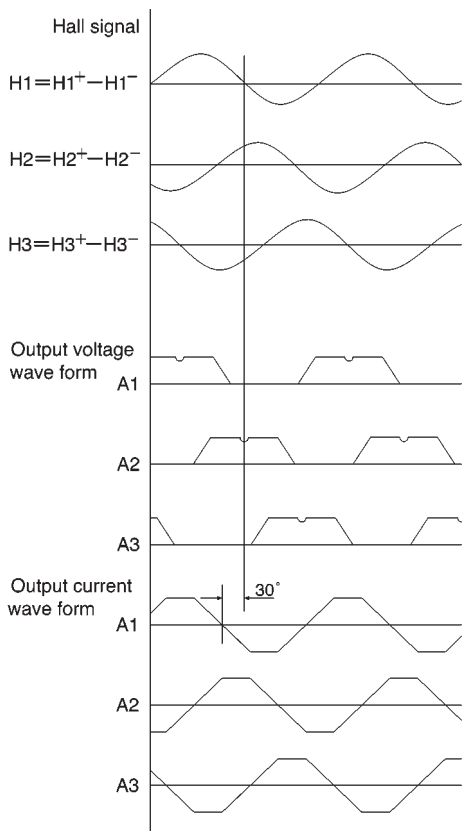

Fig. 5

(2) Torque control pin

The  $R_{NF}$ -pin current depends on the torque control input voltage ( $E_C$ ) as shown in Fig. 6.

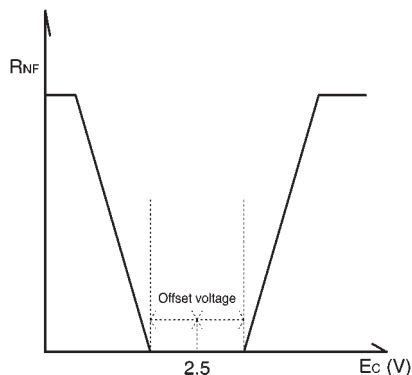

Fig. 6

	Reverse pin voltage	
	H	L
$E_{CR} < E_C$	Reverse	Forward
$E_{CR} > E_C$	Stop	Reverse

(3) Start / stop pin

The motor is in the run mode when the pin input voltage is 3.5V or more, and in the idle mode (all output transistors are off) when the voltage is 1.5V or less.

(4) Power ground pin ( $R_{NF}$  pin)

The  $R_{NF}$  pin is the output stage ground pin. Connect a resistor ( $0.5\Omega$  recommended) between this pin and the ground to monitor the output current.

(5) Phase compensation pin ( $C_{NF}$  pin)

Connect and adjust a capacitor between this pin and the ground if the output tends to oscillate.

● Pin descriptions

Pin name	BA6840BFS	BA6840BFP-Y	BA6840BFP	BA6842BFS	Function
GND	1	FIN	FIN	8, 9, 23, 24, 25	Ground
A <sub>3</sub>	2	3	3	1	Output
A <sub>2</sub>	3	4	4	4	Output
R <sub>NF</sub>	4	6	5	5	Current detector output
A <sub>1</sub>	5	7	6	7	Output
GND	6	8	7	10	Ground
H <sub>1</sub> <sup>+</sup>	7	9	9	11	Hall signal input
H <sub>1</sub> <sup>-</sup>	8	10	10	12	Hall signal input
H <sub>2</sub> <sup>+</sup>	9	11	13	13	Hall signal input
H <sub>2</sub> <sup>-</sup>	10	12	14	15	Hall signal input
H <sub>3</sub> <sup>+</sup>	11	13	15	16	Hall signal input
H <sub>3</sub> <sup>-</sup>	12	14	16	17	Hall signal input
V <sub>H</sub>	13	15	17	18	Hall bias
C <sub>NF</sub>	14	17	20	21	Capacitor for phase compensation connection
E <sub>CR</sub>	15	18	21	22	Standard output current control
E <sub>C</sub>	16	19	22	26	Output current control
ST / SP	17	20	23	27	Start / stop switch
REV	18	22	24	29	Reverse
V <sub>CC</sub>	19	23	25	30	Power supply
V <sub>M</sub>	20	24	26	31	Motor power supply

● Input / output circuits

(1) Start / stop

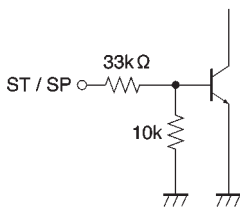

(Resistances are typical values.)

Fig. 7

(2) Reversing pin

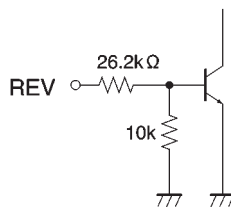

(Resistances are typical values.)

Fig. 8

(3) Hall bias

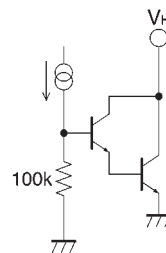

(Resistances are typical values.)

Fig. 9

(4) Torque control input

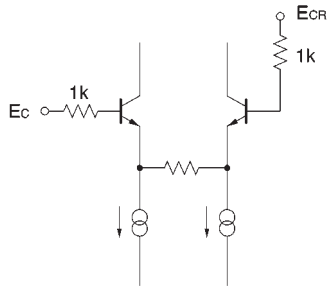

(Resistances are typical values.)

Fig. 10

(5) Coil output

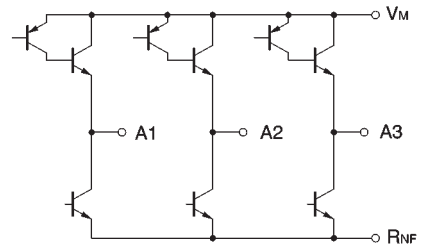
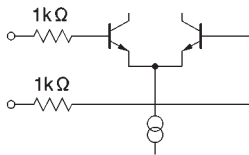

Fig. 11

(6) Hall input (H1<sup>+</sup>, H1<sup>-</sup>, H2<sup>+</sup>, H2<sup>-</sup>, H3<sup>+</sup>, H3<sup>-</sup>)



(Resistances are typical values.)

Fig. 12

● Operation notes

(1) Start / stop

The I / O equivalent circuit of the start / stop pin is shown in Fig. 7. The pin has a temperature dependence of  $-7\text{mV} / ^\circ\text{C}$ , and the resistance can vary  $\pm 30\%$ . Take the temperature effect into consideration when designing your application.

(2) Hall input

The Hall input equivalent circuit is shown in Fig. 12. The Hall devices can be connected in either series or parallel.

(3) Thermal shutdown circuit (TSD)

The circuit puts the coil outputs (A<sub>1</sub>, A<sub>2</sub>, and A<sub>3</sub>) to the open state at the temperature of 175°C (typical). There is a temperature difference of about 15°C between the temperatures at which the circuit is activated and deactivated.

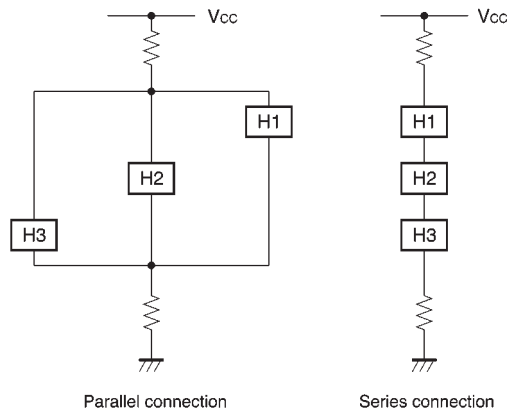

Fig. 13

●Application example

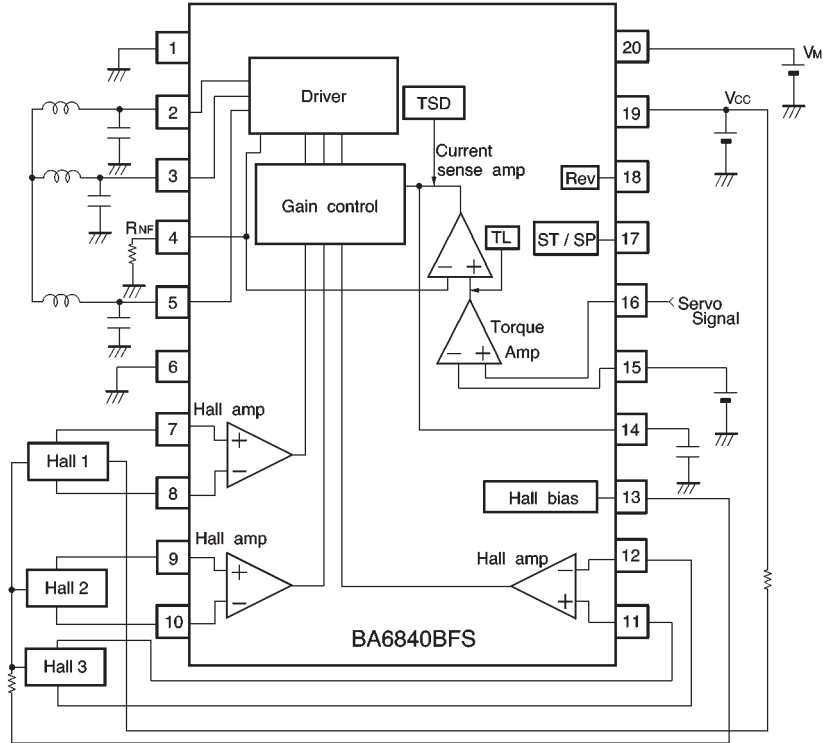

Fig.14



● External dimensions (Units: mm)

