

SEMİTRANS® M Power MOSFET Modules SKM 214 A

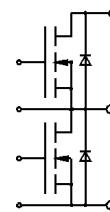

SEMİTRANS 2



Features

- N Channel, enhancement mode
- Avalanche characteristic
- Short internal connections avoid oscillations
- Isolated copper baseplate
- All electrical connections on top for easy busbaring
- Large clearances (10 mm) and creepage distances (20 mm)
- UL recognized, file no. E 63 532

Typical Applications

- Switched mode power supplies
- DC servo and robot drives
- DC choppers
- UPS equipment
- Not suitable for linear amplification

This is an electrostatic discharge sensitive device (ESDS). Please observe the international standard IEC 747-1, Chapter IX.

Absolute Maximum Ratings			
Symbol	Conditions ¹⁾	Values	Units
V _{DS}		100	V
V _{DGR}	R _{GS} = 20 kΩ	100	V
I _D		125	A
I _{DM}		375	A
V _{GS}		± 20	V
P _D		400	W
T _j , (T _{stg})		- 40 ... +150 (125)	°C
V _{isol}	AC, 1 min	2 500	V
humidity	DIN 40 040	Class F	
climate	DIN IEC 68 T.1	40/125/56	
Inverse Diode			
I _F = - I _D		125	A
I _{FM} = - I _{DM}		375	A

Characteristics					
Symbol	Conditions ¹⁾	min.	typ.	max.	Units
V _{(BR)DSS}	V _{GS} = 0, I _D = 0,25 mA	100	-	-	V
V _{GS(th)}	V _{GS} = V _{DS} , I _D = 1 mA	2,1	3,0	4,0	V
I _{DSS}	V _{GS} = 0, } T _j = 25 °C	-	50	250	μA
		V _{DS} = 100 V } T _j = 125 °C	-	300	1000
I _{GSS}	V _{GS} = 20 V, V _{DS} = 0		-	10	100
R _{DS(on)}	V _{GS} = 10 V, I _D = 78 A	-	10	13	mΩ
g _{fs}	V _{DS} = 25 V, I _D = 78 A	40	60	-	S
C _{CHC}	per MOSFET	-	-	100	pF
C _{iss}	V _{GS} = 0 } V _{DS} = 25 V } f = 1 MHz	-	9	12	nF
C _{oss}		-	4	6	nF
C _{rss}		-	1,6	2,4	nF
L _{DS}		-	-	20	nH
t _{d(on)}	V _{DD} = 50 V } I _D = 78 A	-	50	-	ns
t _r		-	190	-	ns
t _{d(off)}	V _{GS} = 10 V } R _{GS} = 3,3 Ω	-	190	-	ns
t _f		-	50	-	ns
Inverse Diode					
V _{SD}	I _F = 250 A, V _{GS} = 0	-	1,25	1,6	V
t _{rr}	T _j = 25 °C ²⁾	-	320	-	ns
Q _{rr}	T _j = 150 °C ²⁾	-	-	-	ns
	T _j = 25 °C ²⁾	-	3,6	-	μC
Thermal Characteristics					
	R _{thjc}	per MOSFET	-	-	0,31
R _{thch}	per module	-	-	0,07	°C/W

Mechanical Data					
M ₁	to heatsink, SI Units	4	-	5	Nm
	to heatsink, US Units	35	-	44	lb.in.
M ₂	for terminals, SI Units	2,5	-	3,5	Nm
	for terminals, US Units	22	-	24	lb.in.
a		-	-	5x9,81	m/s ²
w		-	-	160	g
Case	→ page B 5 - 2	D 70			

¹⁾ T_{case} = 25 °C, unless otherwise specified.

²⁾ I_F = - I_D, V_R = 100 V, - di_F/dt = 100 A/μs

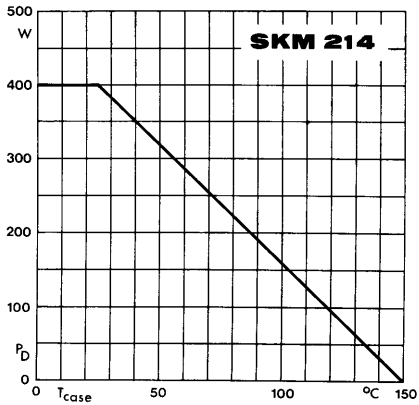

Fig. 1 Rated power dissipation vs. temperature

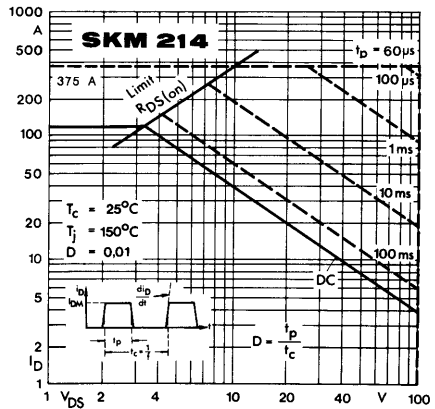

Fig. 2 Maximum safe operating area

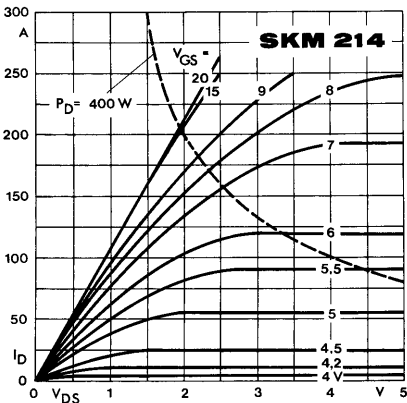

Fig. 3 Output characteristic

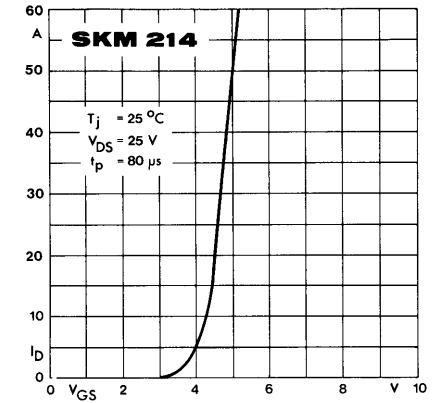

Fig. 4 Transfer characteristic

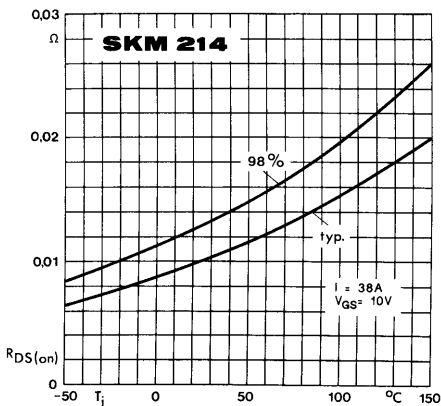

Fig. 5 On-resistance vs. temperature

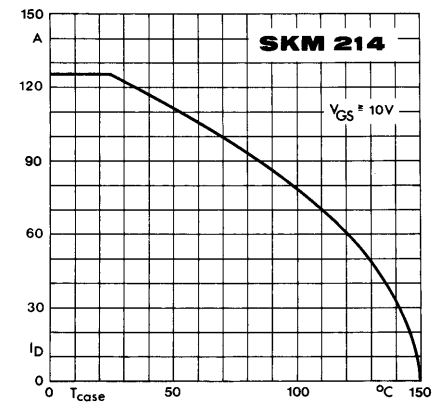

Fig. 6 Rated current vs. temperature

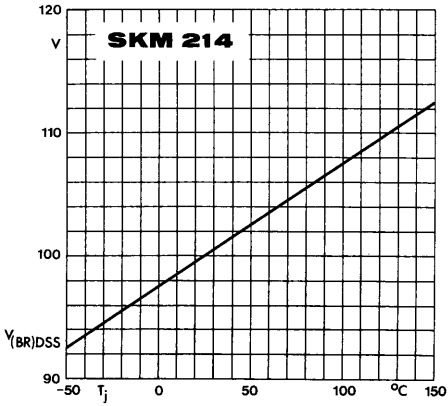

Fig. 7 Breakdown voltage vs. temperature

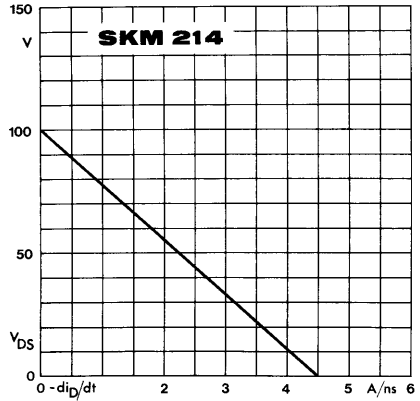

Fig. 8 Drain-source voltage derating

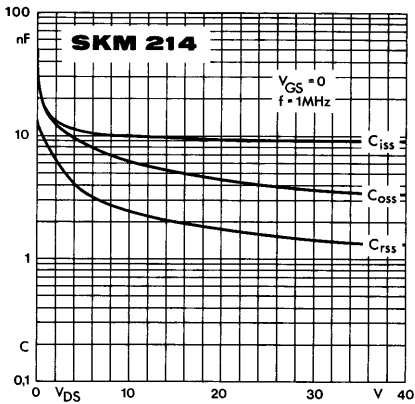

Fig. 9 Capacitances vs. drain-source voltage

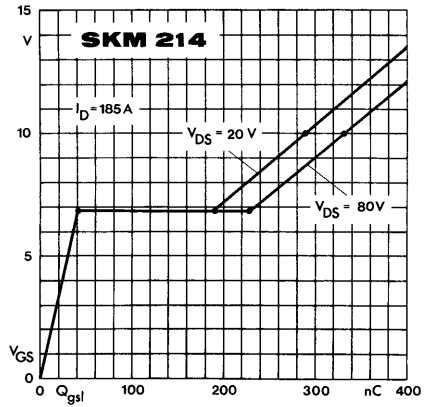

Fig. 10 Gate charge characteristic

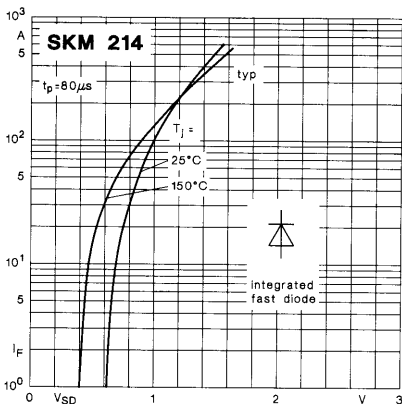

Fig. 11 Diode forward characteristic

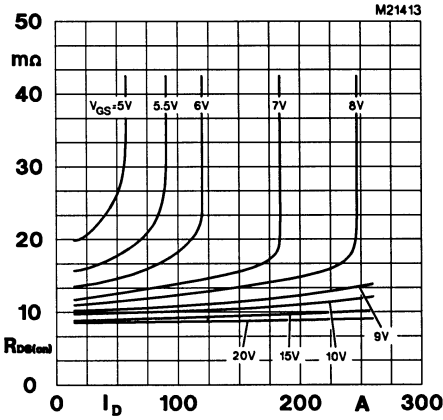

Fig. 13 On-resistance vs. drain current

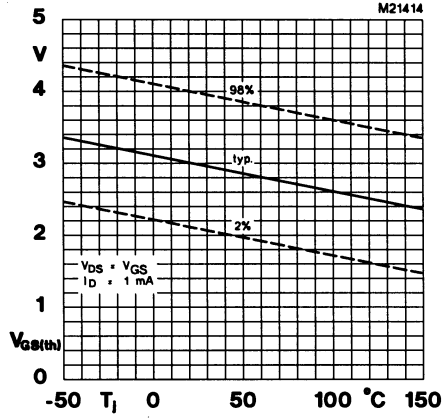

Fig. 14 Gate-source threshold voltage

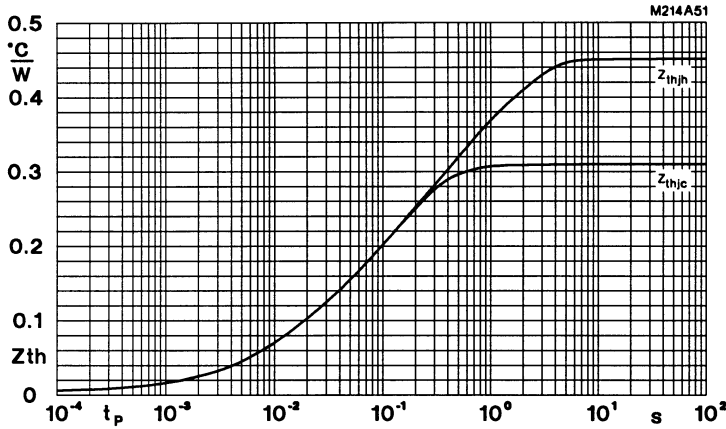

Fig. 51 Transient thermal impedance

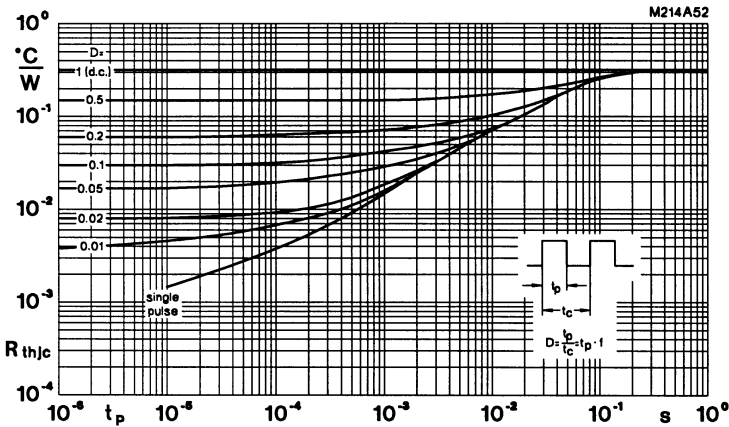
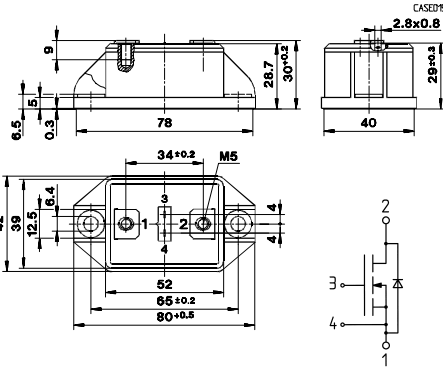

Fig. 52 Thermal impedance under pulse conditions

SEMISTRANS® M1

Case D 15
 SKM 111 AR
 SKM 121 AR
 SKM 151 AR
 SKM 180 A 020
 SKM 181 A3 (R)

UL recognized
 File No. E 63 532



Dimensions in mm

w = 130 g

SEMISTRANS® M2

Case D 70
 SKM 120 B 020
 SKM 204 A
 SKM 214 A

UL recognized
 File No. E 63 532

CASED70

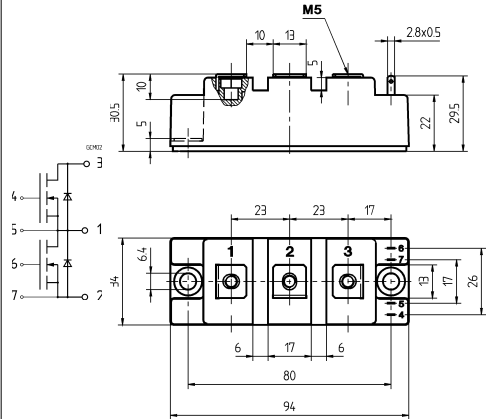

Dimensions in mm

w = 160 g

SEMISTRANS® M3

(SINGLE)
 Case D 71
 SKM 453 A 020

UL recognized
 File No. E 63 532

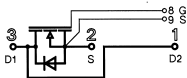

CASED71

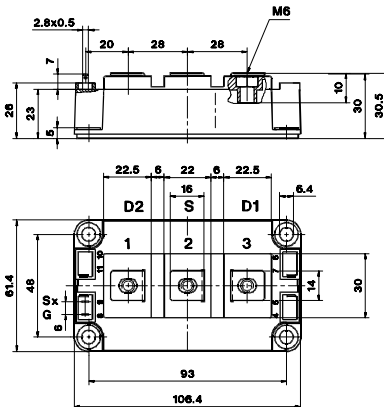

→ B 5 – 18

Dimensions in mm

w = 325 g

SEMISTRANS® 3

(DUAL)
 Case D 56
 SKM 253 B 020
 SKM 313 B 010

UL recognized
 File No. E 63 532

CASED56

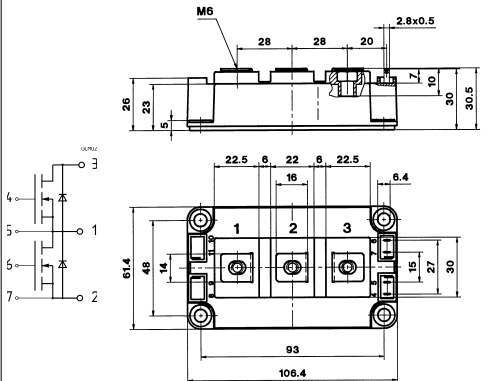

Dimensions in mm

w = 325 g