

LMV931 SINGLE, LMV932 DUAL, LMV934 QUAD 1.8-V OPERATIONAL AMPLIFIERS WITH RAIL-TO-RAIL INPUT AND OUTPUT

SLOS441F – AUGUST 2004 – REVISED FEBRUARY 2005

- 1.8-V, 2.7-V, and 5-V Specifications
- Rail-to-Rail Output Swing
 - 600-Ω Load . . . 80 mV From Rail
 - 2-kΩ Load . . . 30 mV From Rail
- V_{ICR} . . . 200 mV Beyond Rails
- Gain Bandwidth . . . 1.4 MHz
- Supply Current . . . 100 μA/Amplifier
- Max V_{IO} . . . 4 mV
- Space-Saving Packages
 - LMV931: SOT-23 and SC-70
 - LMV932: MSOP and SOIC
 - LMV934: SOIC and TSSOP
- Applications
 - Industrial (Utility/Energy Metering)
 - Automotive
 - Communications (Optical Telecom, Data/Voice Cable Modems)
 - Consumer Electronics (PDAs, PCs, CDR/W, Portable Audio)
 - Supply-Current Monitoring
 - Battery Monitoring

LMV931 . . . DBV (SOT23-5) OR DCK (SC-70) PACKAGE
(TOP VIEW)

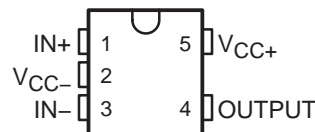

LMV932 . . . D (SOIC) OR
DGK (VSSOP/MSOP) PACKAGE
(TOP VIEW)

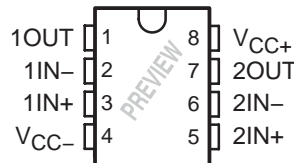

LMV934 . . . D (SOIC) OR PW (TSSOP) PACKAGE
(TOP VIEW)

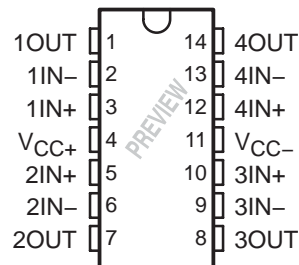

description/ordering information

ORDERING INFORMATION

T_A	PACKAGE†		ORDERABLE PART NUMBER	TOP-SIDE MARKING‡	
-40°C to 125°C	Single	SOT-23 (DBV)	Reel of 3000	LMV931IDBVR	RBB_
			Reel of 250	LMV931IDBVT	PREVIEW
		SC-70 (DCK)	Reel of 3000	LMV931IDCKR	RB_
			Reel of 250	LMV931IDCKT	PREVIEW
	Dual	MSOP/VSSOP (DGK)	Reel of 2500	LMV932IDGKR	PREVIEW
			Reel of 250	LMV932IDGKT	
		SOIC (D)	Tube of 75	LMV932ID	PREVIEW
			Reel of 2500	LMV932IDR	
	Quad	SOIC (D)	Tube of 50	LMV934ID	PREVIEW
			Reel of 2500	LMV934IDR	
		TSSOP (PW)	Tube of 90	LMV934IPW	PREVIEW
			Reel of 2000	LMV934IPWR	

† Package drawings, standard packing quantities, thermal data, symbolization, and PCB design guidelines are available at www.ti.com/sc/package.

‡ DBV/DCK/DGK: The actual top-side marking has one additional character that designates the assembly/test site.



Please be aware that an important notice concerning availability, standard warranty, and use in critical applications of Texas Instruments semiconductor products and disclaimers thereto appears at the end of this data sheet.

PRODUCTION DATA information is current as of publication date. Products conform to specifications per the terms of Texas Instruments standard warranty. Production processing does not necessarily include testing of all parameters.

**TEXAS
INSTRUMENTS**

POST OFFICE BOX 655303 • DALLAS, TEXAS 75265

Copyright © 2005, Texas Instruments Incorporated

LMV931 SINGLE, LMV932 DUAL, LMV934 QUAD 1.8-V OPERATIONAL AMPLIFIERS WITH RAIL-TO-RAIL INPUT AND OUTPUT

SLOS441F – AUGUST 2004 – REVISED FEBRUARY 2005

description/ordering information (continued)

The LMV93x devices are low-voltage, low-power, operational amplifiers that are well suited for today's low-voltage and/or portable applications. Specified for operation of 1.8 V to 5 V, they can be used in portable applications that are powered from a single-cell Li-ion or two-cell batteries. They have rail-to-rail input and output capability for maximum signal swings in low-voltage applications. The LMV93x input common-mode voltage extends 200 mV beyond the rails for increased flexibility. The output can swing rail-to-rail unloaded and typically can reach 80 mV from the rails, while driving a 600-Ω load (at 1.8-V operation).

During 1.8-V operation, the devices typically consume a quiescent current of 103 μA per channel, and yet they are able to achieve excellent electrical specifications, such as 101-dB open-loop DC gain and 1.4-MHz gain bandwidth. Furthermore, the amplifiers offer good output drive characteristics, with the ability to drive a 600-Ω load and 1000-pF capacitance with minimal ringing.

The LMV93x devices are offered in the latest packaging technology to meet the most demanding space-constraint applications. The LMV931 is offered in standard SOT-23 and SC-70 packages. The LMV932 is available in the traditional MSOP and SOIC packages. The LMV934 is available in the traditional SOIC and TSSOP packages.

The LMV93x devices are characterized for operation from -40°C to 125°C, making the part universally suited for commercial, industrial, and automotive applications.

simplified schematic

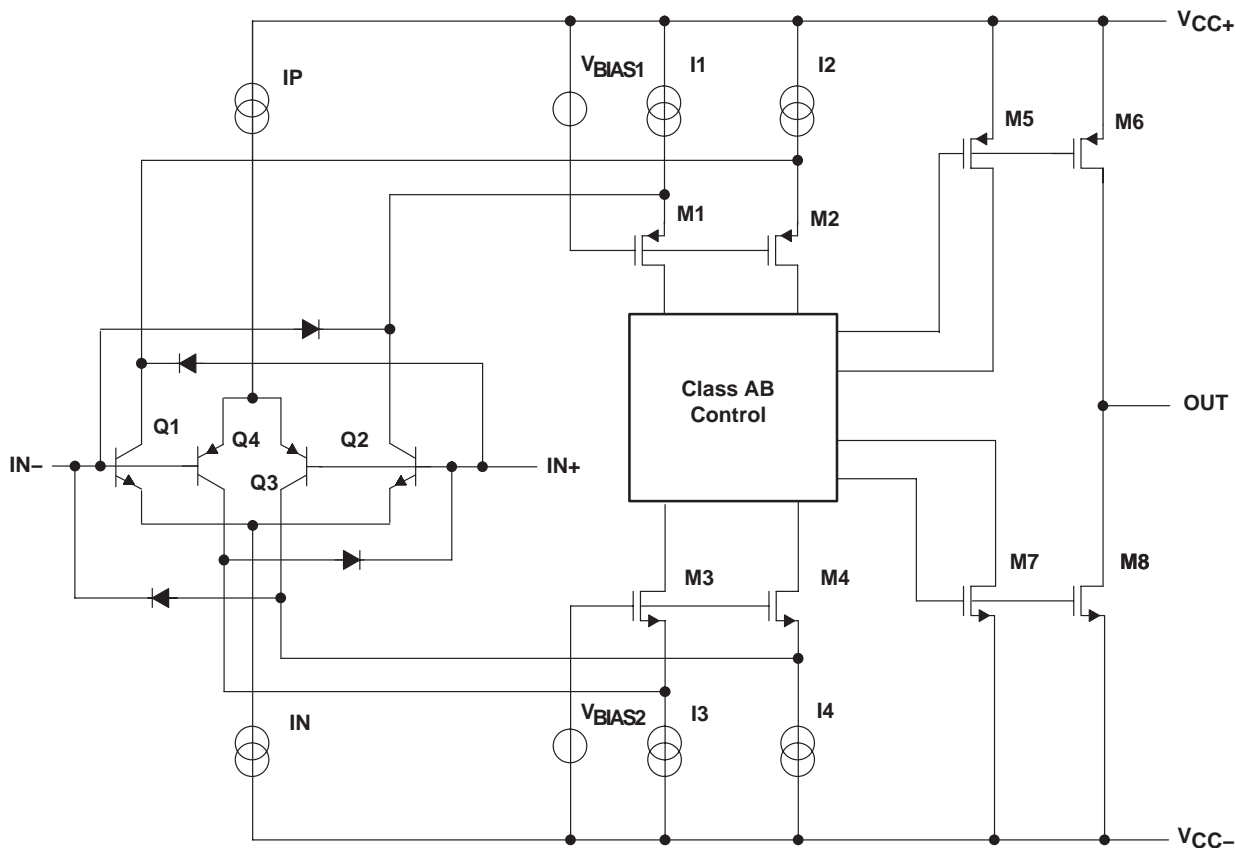

LMV931 SINGLE, LMV932 DUAL, LMV934 QUAD 1.8-V OPERATIONAL AMPLIFIERS WITH RAIL-TO-RAIL INPUT AND OUTPUT

SLOS441F – AUGUST 2004 – REVISED FEBRUARY 2005

absolute maximum ratings over free-air temperature range (unless otherwise noted)†

Supply voltage, $V_{CC+} - V_{CC-}$ (see Note 1)	5.5 V
Differential input voltage, V_{ID} (see Note 2)	Supply voltage
Input voltage range, V_I (either input)	$V_{CC-} - 0.2\text{ V}$ to $V_{CC+} + 0.2\text{ V}$
Duration of output short circuit (one amplifier) to $V_{CC\pm}$ (see Notes 3 and 4)	Unlimited
Package thermal impedance, θ_{JA} (see Notes 4 and 5): D package (8 pin)	97°C/W
D package (14 pin)	86°C/W
DBV package	206°C/W
DCK package	252°C/W
DGK package	172°C/W
PW package	113°C/W
Operating virtual junction temperature, T_J	150°C
Storage temperature range, T_{Stg}	–65 to 150°C

† Stresses beyond those listed under “absolute maximum ratings” may cause permanent damage to the device. These are stress ratings only, and functional operation of the device at these or any other conditions beyond those indicated under “recommended operating conditions” is not implied. Exposure to absolute-maximum-rated conditions for extended periods may affect device reliability.

- NOTES:
1. All voltage values (except differential voltages and V_{CC} specified for the measurement of I_{OS}) are with respect to the network GND.
 2. Differential voltages are at $IN+$ with respect to $IN-$.
 3. Applies to both single-supply and split-supply operation. Continuous short-circuit operation at elevated ambient temperature can result in exceeding the maximum allowed junction temperature of 150°C. Output currents in excess of 45 mA over long term may adversely affect reliability.
 4. Maximum power dissipation is a function of $T_{J(max)}$, θ_{JA} , and T_A . The maximum allowable power dissipation at any allowable ambient temperature is $P_D = (T_{J(max)} - T_A)/\theta_{JA}$. Operating at the absolute maximum T_J of 150°C can affect reliability.
 5. The package thermal impedance is calculated in accordance with JESD 51-7.

recommended operating conditions

	MIN	MAX	UNIT
V_{CC} Supply voltage ($V_{CC+} - V_{CC-}$)	1.8	5	V
T_A Operating free-air temperature	–40	125	°C

ESD protection

TEST CONDITIONS	TYP	UNIT
Human-Body Model	2000	V
Machine Model	200	V



LMV931 SINGLE, LMV932 DUAL, LMV934 QUAD 1.8-V OPERATIONAL AMPLIFIERS WITH RAIL-TO-RAIL INPUT AND OUTPUT

SLOS441F – AUGUST 2004 – REVISED FEBRUARY 2005

electrical characteristics at $T_A = 25^\circ\text{C}$, $V_{CC+} = 1.8\text{ V}$, $V_{CC-} = 0\text{ V}$, $V_{IC} = V_{CC+}/2$, $V_O = V_{CC+}/2$, and $R_L > 1\text{ M}\Omega$ (unless otherwise noted)

PARAMETER		TEST CONDITIONS	T_A	MIN	TYP	MAX	UNIT
V_{IO}	Input offset voltage	LMV931 (single)	25°C		1	4	mV
			Full range			6	
		LMV932 (dual), LMV934 (quad)	25°C		1	5.5	
			Full range			7.5	
αV_{IO}	Average temperature coefficient of input offset voltage		25°C		5.5		$\mu\text{V}/^\circ\text{C}$
I_{IB}	Input bias current	$V_{IC} = V_{CC+} - 0.8\text{ V}$	25°C		15	35	nA
			25°C			65	
			Full range			75	
I_{IO}	Input offset current		25°C		13	25	nA
			Full range			40	
I_{CC}	Supply current (per channel)		25°C		103	185	μA
			Full range			205	
CMRR	Common-mode rejection ratio	$0 \leq V_{IC} \leq 0.6\text{ V}$, $1.4\text{ V} \leq V_{IC} \leq 1.8\text{ V}$	25°C	60	78	dB	
			-40°C to 85°C	55			
		$0.2\text{ V} \leq V_{IC} \leq 0.6\text{ V}$, $1.4\text{ V} \leq V_{IC} \leq 1.6\text{ V}$	-40°C to 125°C	55			
k_{SVR}	Supply-voltage rejection ratio	$1.8\text{ V} \leq V_{CC+} \leq 5\text{ V}$, $V_{IC} = 0.5\text{ V}$	25°C	75	100	dB	
			Full range	70			
V_{ICR}	Common-mode input voltage range	CMRR $\geq 50\text{ dB}$	25°C	$V_{CC-} - 0.2$	$-0.2\text{ to }2.1$	$V_{CC+} + 0.2$	V
			-40°C to 85°C	V_{CC-}		V_{CC+}	
			-40°C to 125°C	$V_{CC-} + 0.2$		$V_{CC+} - 0.2$	
A_V	Large-signal voltage gain	LMV931	$R_L = 600\ \Omega$ to 0.9 V, $V_O = 0.2\text{ V}$ to 1.6 V, $V_{IC} = 0.5\text{ V}$	25°C	77	101	dB
			Full range	73			
		LMV932	$R_L = 2\text{ k}\Omega$ to 0.9 V, $V_O = 0.2\text{ V}$ to 1.6 V, $V_{IC} = 0.5\text{ V}$	25°C	80	105	
			Full range	75			
		LMV934	$R_L = 600\ \Omega$ to 0.9 V, $V_O = 0.2\text{ V}$ to 1.6 V, $V_{IC} = 0.5\text{ V}$	25°C	75	90	
			Full range	72			
LMV934	$R_L = 2\text{ k}\Omega$ to 0.9 V, $V_O = 0.2\text{ V}$ to 1.6 V, $V_{IC} = 0.5\text{ V}$	25°C	78	100			
	Full range	75					



**LMV931 SINGLE, LMV932 DUAL, LMV934 QUAD
1.8-V OPERATIONAL AMPLIFIERS
WITH RAIL-TO-RAIL INPUT AND OUTPUT**

SLOS441F – AUGUST 2004 – REVISED FEBRUARY 2005

electrical characteristics at $T_A = 25^\circ\text{C}$, $V_{CC+} = 1.8\text{ V}$, $V_{CC-} = 0\text{ V}$, $V_{IC} = V_{CC+}/2$, $V_O = V_{CC+}/2$, and $R_L > 1\text{ M}\Omega$ (unless otherwise noted)(continued)

PARAMETER		TEST CONDITIONS	T_A	MIN	TYP	MAX	UNIT
V_O	Output swing	$R_L = 600\ \Omega$ to 0.9 V , $V_{ID} = \pm 100\text{ mV}$	High level	25°C	1.65	1.72	V
				Full range	1.63		
			Low level	25°C	0.077	0.105	
				Full range		0.120	
		$R_L = 2\text{ k}\Omega$ to 0.9 V , $V_{ID} = \pm 100\text{ mV}$	High level	25°C	1.75	1.77	
				Full range	1.74		
			Low level	25°C	0.024	0.035	
				Full range		0.04	
I_{OS}	Output short-circuit current	$V_O = 0\text{ V}$, $V_{ID} = 100\text{ mV}$	Sourcing	25°C	4	8	mA
				Full range	3.3		
		$V_O = 1.8\text{ V}$, $V_{ID} = -100\text{ mV}$	Sinking	25°C	7	9	
				Full range	5		
GBW	Gain bandwidth product		25°C		1.4	MHz	
SR	Slew rate	See Note 6	25°C		0.35	V/ μS	
Φ_m	Phase margin		25°C		67	$^\circ$	
	Gain margin		25°C		7	dB	
V_n	Equivalent input noise voltage	$f = 1\text{ kHz}$, $V_{IC} = 0.5\text{ V}$	25°C		60	nV/ $\sqrt{\text{Hz}}$	
I_n	Equivalent input noise current	$f = 1\text{ kHz}$	25°C		0.06	pA/ $\sqrt{\text{Hz}}$	
THD	Total harmonic distortion	$f = 1\text{ kHz}$, $A_V = 1$, $R_L = 600\ \Omega$, $V_{ID} = 1\text{ V}_{p-p}$	25°C		0.023	%	
	Amp-to-amp isolation	See Note 7	25°C		123	dB	

- NOTES: 6. Number specified is the slower of the positive and negative slew rates.
7. Input referred, $V_{CC+} = 5\text{ V}$ and $R_L = 100\text{ k}\Omega$ connected to 2.5 V . Each amp is excited, in turn, with a 1-kHz signal to produce $V_O = 3\text{ V}_{p-p}$.

LMV931 SINGLE, LMV932 DUAL, LMV934 QUAD 1.8-V OPERATIONAL AMPLIFIERS WITH RAIL-TO-RAIL INPUT AND OUTPUT

SLOS441F – AUGUST 2004 – REVISED FEBRUARY 2005

electrical characteristics at $T_A = 25^\circ\text{C}$, $V_{CC+} = 2.7\text{ V}$, $V_{CC-} = 0\text{ V}$, $V_{IC} = V_{CC+}/2$, $V_O = V_{CC+}/2$, and $R_L > 1\text{ M}\Omega$ (unless otherwise noted)

PARAMETER		TEST CONDITIONS	T_A	MIN	TYP	MAX	UNIT
V_{IO}	Input offset voltage	LMV931 (single)	25°C		1	4	mV
			Full range			6	
		LMV932 (dual), LMV934 (quad)	25°C		1	5.5	
			Full range			7.5	
αV_{IO}	Average temperature coefficient of input offset voltage		25°C		5.5		$\mu\text{V}/^\circ\text{C}$
I_{IB}	Input bias current	$V_{IC} = V_{CC+} - 0.8\text{ V}$	25°C		15	35	nA
			25°C			65	
			Full range			75	
I_{IO}	Input offset current		25°C		8	25	nA
			Full range			40	
I_{CC}	Supply current (per channel)		25°C		105	190	μA
			Full range			210	
CMRR	Common-mode rejection ratio	$0 \leq V_{IC} \leq 1.5\text{ V}$, $2.3\text{ V} \leq V_{IC} \leq 2.7\text{ V}$	25°C	60	81	dB	
			-40°C to 85°C	55			
		$0.2 \leq V_{IC} \leq 1.5\text{ V}$, $2.3\text{ V} \leq V_{IC} \leq 2.5\text{ V}$	-40°C to 125°C	55			
k_{SVR}	Supply-voltage rejection ratio	$1.8\text{ V} \leq V_{CC+} \leq 5\text{ V}$, $V_{IC} = 0.5\text{ V}$	25°C	75	100	dB	
			Full range	70			
V_{ICR}	Common-mode input voltage range	CMRR $\geq 50\text{ dB}$	25°C	$V_{CC-} - 0.2$	-0.2 to 3.0	$V_{CC+} + 0.2$	V
			-40°C to 85°C	V_{CC-}		V_{CC+}	
			-40°C to 125°C	$V_{CC-} + 0.2$		$V_{CC+} - 0.2$	
A_V	Large-signal voltage gain	LMV931	$R_L = 600\ \Omega$ to 1.35 V, $V_O = 0.2\text{ V}$ to 2.5 V	25°C	87	104	dB
			Full range	86			
		LMV932, LMV934	$R_L = 2\text{ k}\Omega$ to 1.35 V, $V_O = 0.2\text{ V}$ to 2.5 V	25°C	92	110	
			Full range	91			
			$R_L = 600\ \Omega$ to 1.35 V, $V_O = 0.2\text{ V}$ to 2.5 V	25°C	78	90	
			Full range	75			
			$R_L = 2\text{ k}\Omega$ to 1.35 V, $V_O = 0.2\text{ V}$ to 2.5 V	25°C	81	100	
			Full range	78			

**LMV931 SINGLE, LMV932 DUAL, LMV934 QUAD
1.8-V OPERATIONAL AMPLIFIERS
WITH RAIL-TO-RAIL INPUT AND OUTPUT**

SLOS441F – AUGUST 2004 – REVISED FEBRUARY 2005

electrical characteristics at $T_A = 25^\circ\text{C}$, $V_{CC+} = 2.7\text{ V}$, $V_{CC-} = 0\text{ V}$, $V_{IC} = V_{CC+}/2$, $V_O = V_{CC+}/2$, and $R_L > 1\text{ M}\Omega$ (unless otherwise noted) (continued)

PARAMETER		TEST CONDITIONS	T_A	MIN	TYP	MAX	UNIT		
V_O	Output swing	$R_L = 600\ \Omega$ to 1.35 V, $V_{ID} = \pm 100\text{ mV}$	High level	25°C	2.55	2.62	V		
				Full range	2.53				
			Low level	25°C		0.083		0.11	
				Full range				0.13	
		$R_L = 2\text{ k}\Omega$ to 1.35 V, $V_{ID} = \pm 100\text{ mV}$	High level	25°C	2.65	2.675			
				Full range	2.64				
			Low level	25°C		0.025			0.04
				Full range					0.045
I_{OS}	Output short-circuit current	$V_O = 0\text{ V}$, $V_{ID} = 100\text{ mV}$	Sourcing	25°C	20	30	mA		
				Full range	15				
		$V_O = 2.7\text{ V}$, $V_{ID} = -100\text{ mV}$	Sinking	25°C	18	25			
				Full range	12				
GBW	Gain bandwidth product		25°C		1.4	MHz			
SR	Slew rate	See Note 6	25°C		0.4	V/ μS			
Φ_m	Phase margin		25°C		70	°			
	Gain margin		25°C		7.5	dB			
V_n	Equivalent input noise voltage	$f = 1\text{ kHz}$, $V_{IC} = 0.5\text{ V}$	25°C		57	nV/ $\sqrt{\text{Hz}}$			
I_n	Equivalent input noise current	$f = 1\text{ kHz}$	25°C		0.082	pA/ $\sqrt{\text{Hz}}$			
THD	Total harmonic distortion	$f = 1\text{ kHz}$, $A_V = 1$, $R_L = 600\ \Omega$, $V_{ID} = 1\text{ V}_{p-p}$	25°C		0.022	%			
	Amp-to-amp isolation	See Note 7	25°C		123	dB			

- NOTES: 6. Number specified is the slower of the positive and negative slew rates.
7. Input referred, $V_{CC+} = 5\text{ V}$ and $R_L = 100\text{ k}\Omega$ connected to 2.5 V. Each amp is excited, in turn, with a 1-kHz signal to produce $V_O = 3\text{ V}_{p-p}$.

LMV931 SINGLE, LMV932 DUAL, LMV934 QUAD 1.8-V OPERATIONAL AMPLIFIERS WITH RAIL-TO-RAIL INPUT AND OUTPUT

SLOS441F – AUGUST 2004 – REVISED FEBRUARY 2005

electrical characteristics at $T_A = 25^\circ\text{C}$, $V_{CC+} = 5\text{ V}$, $V_{CC-} = 0\text{ V}$, $V_{IC} = V_{CC+}/2$, $V_O = V_{CC+}/2$, and $R_L > 1\text{ M}\Omega$ (unless otherwise noted)

PARAMETER		TEST CONDITIONS	T_A	MIN	TYP	MAX	UNIT
V_{IO}	Input offset voltage	LMV931 (single)	25°C		1	4	mV
			Full range			6	
		LMV932 (dual), LMV934 (quad)	25°C		1	5.5	
			Full range			7.5	
αV_{IO}	Average temperature coefficient of input offset voltage		25°C		5.5		$\mu\text{V}/^\circ\text{C}$
I_{IB}	Input bias current	$V_{IC} = V_{CC+} - 0.8\text{ V}$	25°C		15	35	nA
			25°C			65	
			Full range			75	
I_{IO}	Input offset current		25°C		9	25	nA
			Full range			40	
I_{CC}	Supply current (per channel)		25°C		116	210	μA
			Full range			230	
CMRR	Common-mode rejection ratio	$0 \leq V_{IC} \leq 3.8\text{ V}$, $4.6 \leq V_{IC} \leq 5\text{ V}$	25°C	60	86	dB	
			-40°C to 85°C	55			
		$0.3 \leq V_{IC} \leq 3.8\text{ V}$, $4.6 \leq V_{IC} \leq 4.7\text{ V}$	-40°C to 125°C	55			
k _{SVR}	Supply-voltage rejection ratio	$1.8\text{ V} \leq V_{CC+} \leq 5\text{ V}$, $V_{IC} = 0.5\text{ V}$	25°C	75	100	dB	
			Full range	70			
V_{ICR}	Common-mode input voltage range	CMRR $\geq 50\text{ dB}$	25°C	$V_{CC-} - 0.2$	-0.2 to 5.3	$V_{CC+} + 0.2$	V
			-40°C to 85°C	V_{CC-}		V_{CC+}	
			-40°C to 125°C	$V_{CC-} + 0.3$		$V_{CC+} - 0.3$	
A_V	Large-signal voltage gain	LMV931	$R_L = 600\ \Omega$ to 2.5 V, $V_O = 0.2\text{ V}$ to 4.8 V	25°C	88	102	dB
			Full range	87			
		$R_L = 2\text{ k}\Omega$ to 2.5 V, $V_O = 0.2\text{ V}$ to 4.8 V	25°C	94	113		
			Full range	93			
		LMV932, LMV934	$R_L = 600\ \Omega$ to 2.5 V, $V_O = 0.2\text{ V}$ to 4.8 V	25°C	81	90	
			Full range	78			
$R_L = 2\text{ k}\Omega$ to 2.5 V, $V_O = 0.2\text{ V}$ to 4.8 V	25°C	85	100				
Full range	82						

**LMV931 SINGLE, LMV932 DUAL, LMV934 QUAD
1.8-V OPERATIONAL AMPLIFIERS
WITH RAIL-TO-RAIL INPUT AND OUTPUT**

SLOS441F – AUGUST 2004 – REVISED FEBRUARY 2005

electrical characteristics at $T_A = 25^\circ\text{C}$, $V_{CC+} = 5\text{ V}$, $V_{CC-} = 0\text{ V}$, $V_{IC} = V_{CC+}/2$, $V_O = V_{CC+}/2$, and $R_L > 1\text{ M}\Omega$ (unless otherwise noted) (continued)

PARAMETER		TEST CONDITIONS	T_A	MIN	TYP	MAX	UNIT
V_O	Output swing	$R_L = 600\ \Omega$ to 2.5 V, $V_{ID} = \pm 100\text{ mV}$	High level	25°C	4.855	4.89	V
				Full range	4.835		
			Low level	25°C	0.12 0.16		
				Full range	0.18		
		$R_L = 2\text{ k}\Omega$ to 2.5 V, $V_{ID} = \pm 100\text{ mV}$	High level	25°C	4.945	4.967	
				Full range	4.935		
			Low level	25°C	0.037 0.065		
				Full range	0.075		
I_{OS}	Output short-circuit current	$V_O = 0\text{ V}$, $V_{ID} = 100\text{ mV}$	Sourcing	25°C	80	100	mA
				Full range	68		
		$V_O = 5\text{ V}$, $V_{ID} = -100\text{ mV}$	Sinking	25°C	58	65	
				Full range	45		
GBW	Gain bandwidth product		25°C	1.5		MHz	
SR	Slew rate	See Note 6	25°C	0.42		V/ μS	
Φ_m	Phase margin		25°C	71		°	
	Gain margin		25°C	8		dB	
V_n	Equivalent input noise voltage	$f = 1\text{ kHz}$, $V_{IC} = 1\text{ V}$	25°C	50		nV/ $\sqrt{\text{Hz}}$	
I_n	Equivalent input noise current	$f = 1\text{ kHz}$	25°C	0.07		pA/ $\sqrt{\text{Hz}}$	
THD	Total harmonic distortion	$f = 1\text{ kHz}$, $A_V = 1$, $R_L = 600\ \Omega$, $V_{ID} = 1\text{ V}_{p-p}$	25°C	0.022		%	
	Amp-to-amp isolation	See Note 7	25°C	123		dB	

- NOTES: 6. Number specified is the slower of the positive and negative slew rates.
7. Input referred, $V_{CC+} = 5\text{ V}$ and $R_L = 100\text{ k}\Omega$ connected to 2.5 V. Each amp is excited, in turn, with a 1-kHz signal to produce $V_O = 3\text{ V}_{p-p}$.

**LMV931 SINGLE, LMV932 DUAL, LMV934 QUAD
1.8-V OPERATIONAL AMPLIFIERS
WITH RAIL-TO-RAIL INPUT AND OUTPUT**

SLOS441F – AUGUST 2004 – REVISED FEBRUARY 2005

TYPICAL PERFORMANCE CHARACTERISTICS
Unless Otherwise Specified, $V_{CC+} = 5\text{ V}$, Single Supply, $T_A = 25^\circ\text{C}$

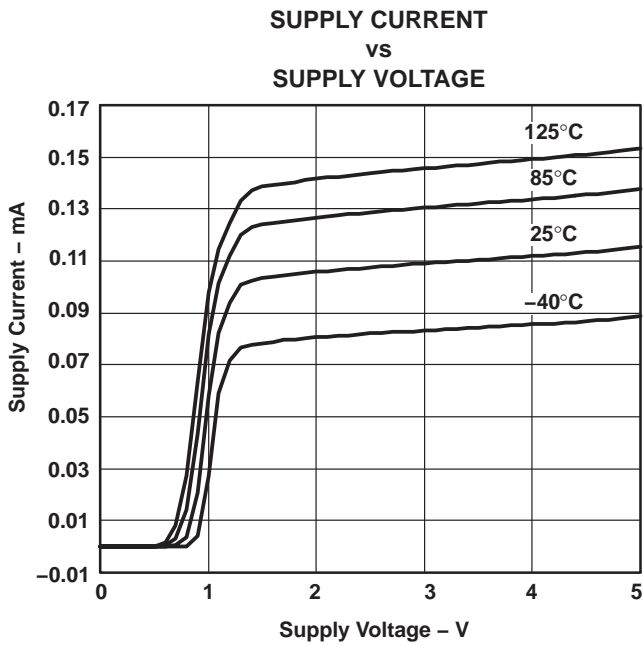

Figure 1

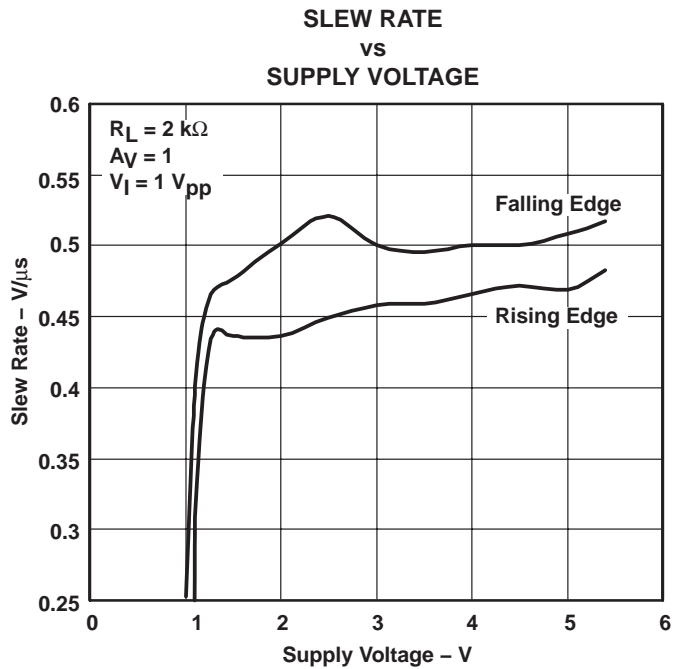

Figure 2

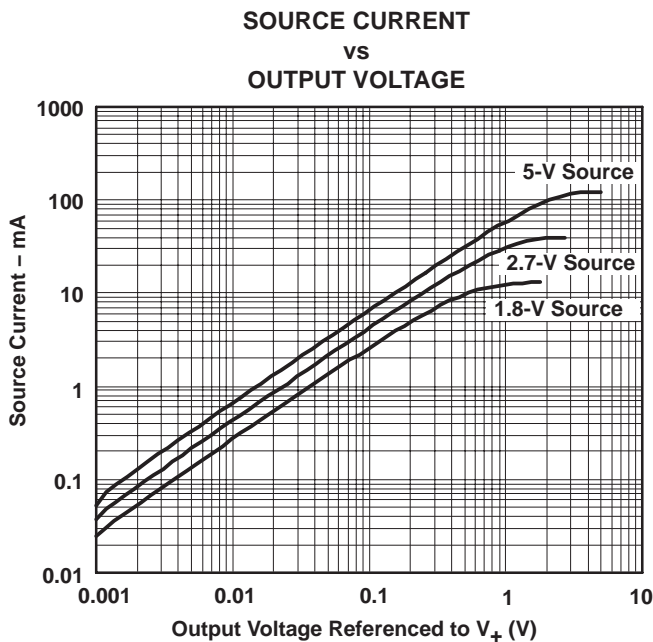

Figure 3

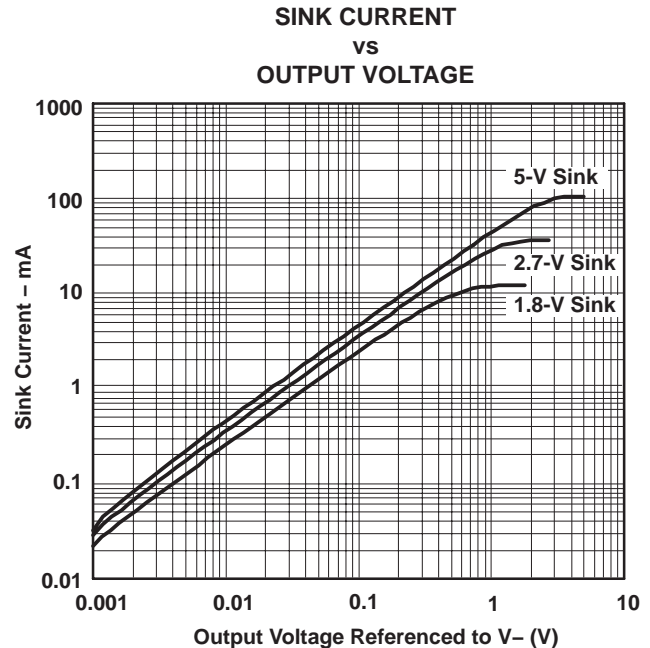

Figure 4

TYPICAL PERFORMANCE CHARACTERISTICS
 Unless Otherwise Specified, $V_{CC+} = 5\text{ V}$, Single Supply, $T_A = 25^\circ\text{C}$

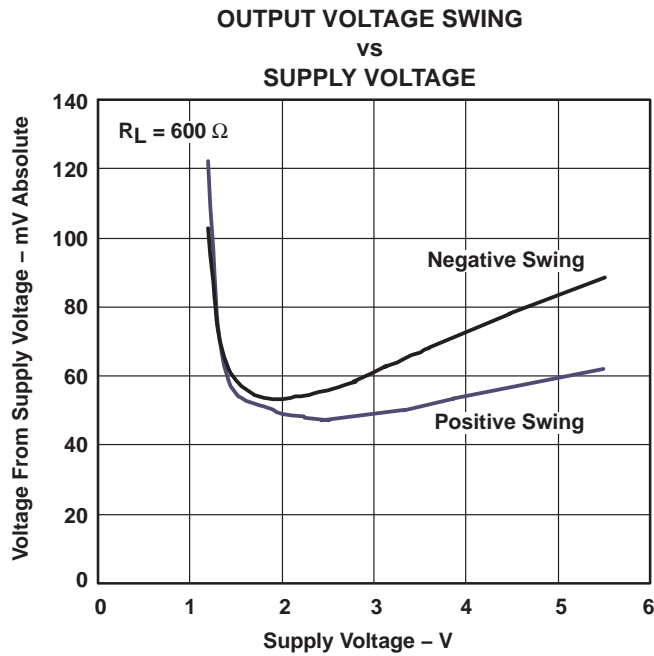

Figure 5

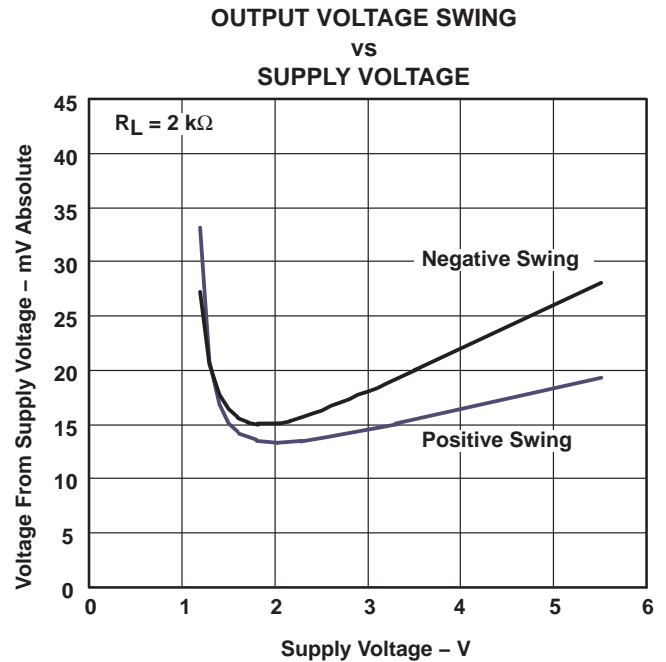

Figure 6

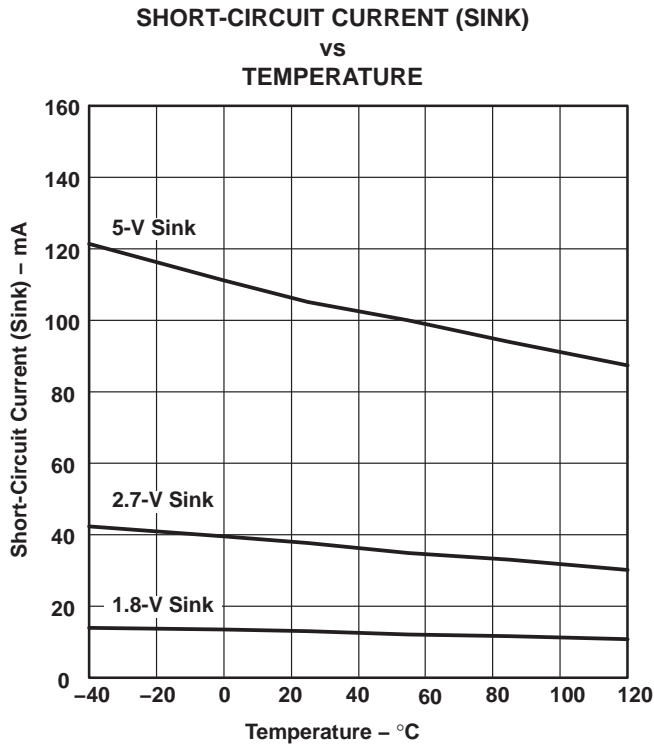

Figure 7

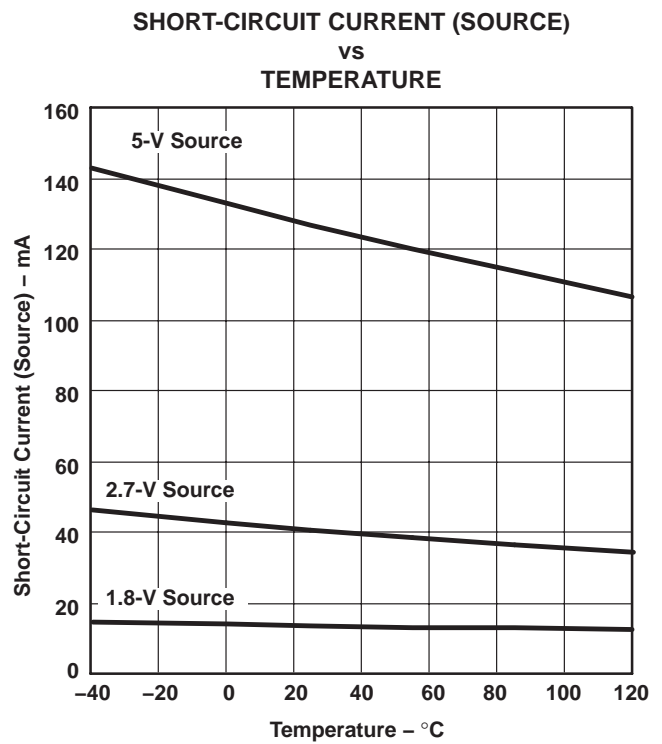

Figure 8

**LMV931 SINGLE, LMV932 DUAL, LMV934 QUAD
1.8-V OPERATIONAL AMPLIFIERS
WITH RAIL-TO-RAIL INPUT AND OUTPUT**

SLOS441F – AUGUST 2004 – REVISED FEBRUARY 2005

TYPICAL PERFORMANCE CHARACTERISTICS
Unless Otherwise Specified, $V_{CC+} = 5\text{ V}$, Single Supply, $T_A = 25^\circ\text{C}$

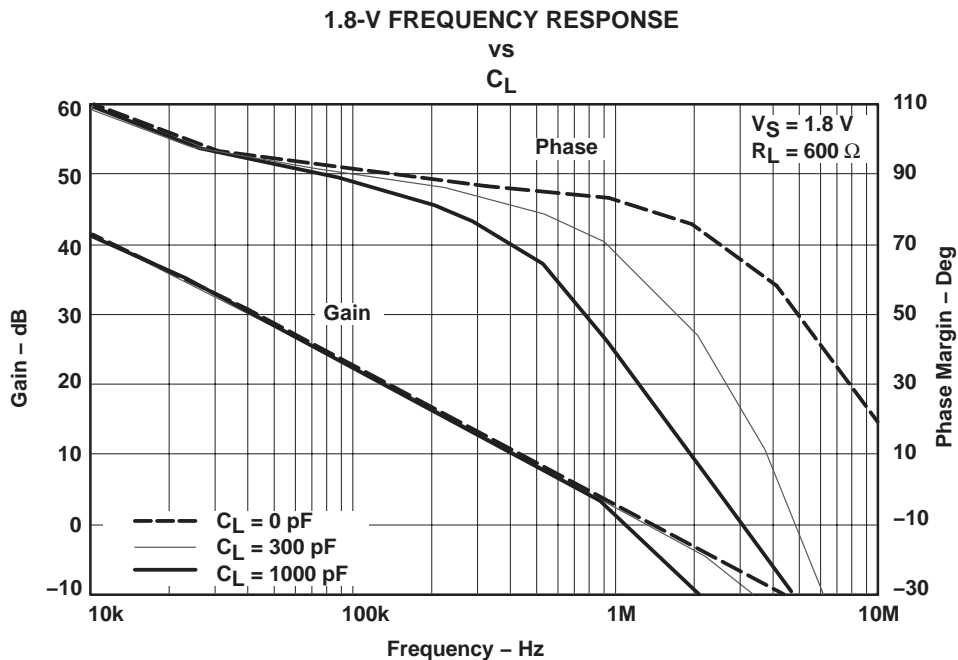

Figure 9

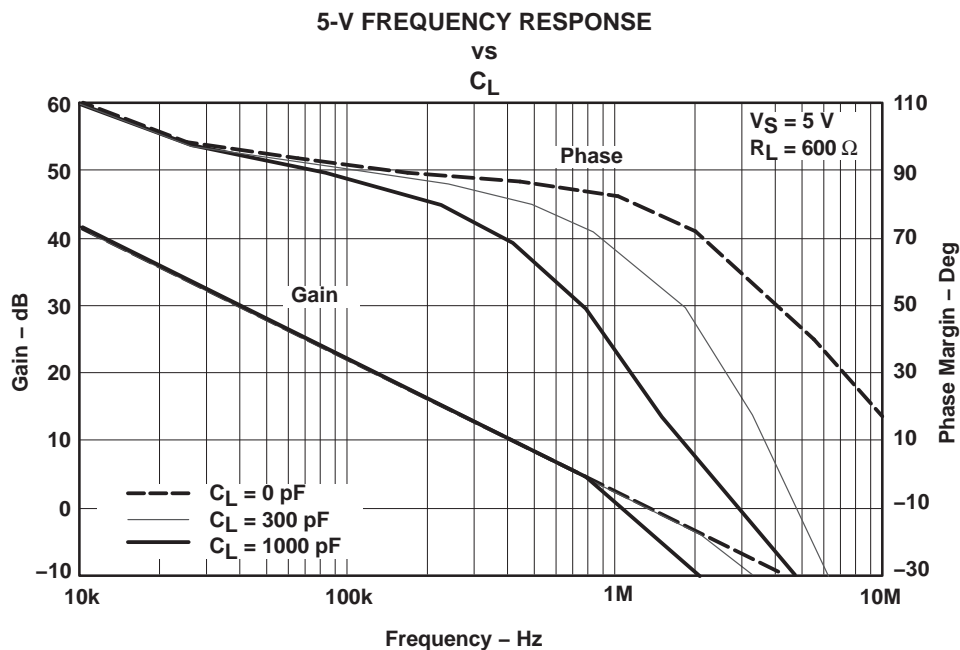

Figure 10



LMV931 SINGLE, LMV932 DUAL, LMV934 QUAD
 1.8-V OPERATIONAL AMPLIFIERS
 WITH RAIL-TO-RAIL INPUT AND OUTPUT

SLOS441F – AUGUST 2004 – REVISED FEBRUARY 2005

TYPICAL PERFORMANCE CHARACTERISTICS
 Unless Otherwise Specified, $V_{CC+} = 5\text{ V}$, Single Supply, $T_A = 25^\circ\text{C}$

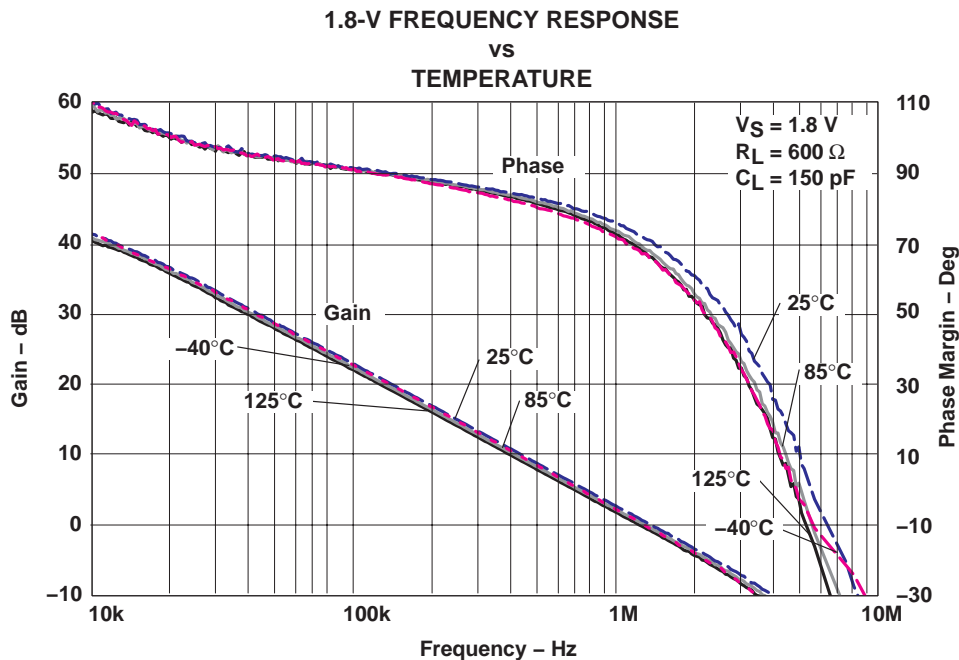

Figure 11

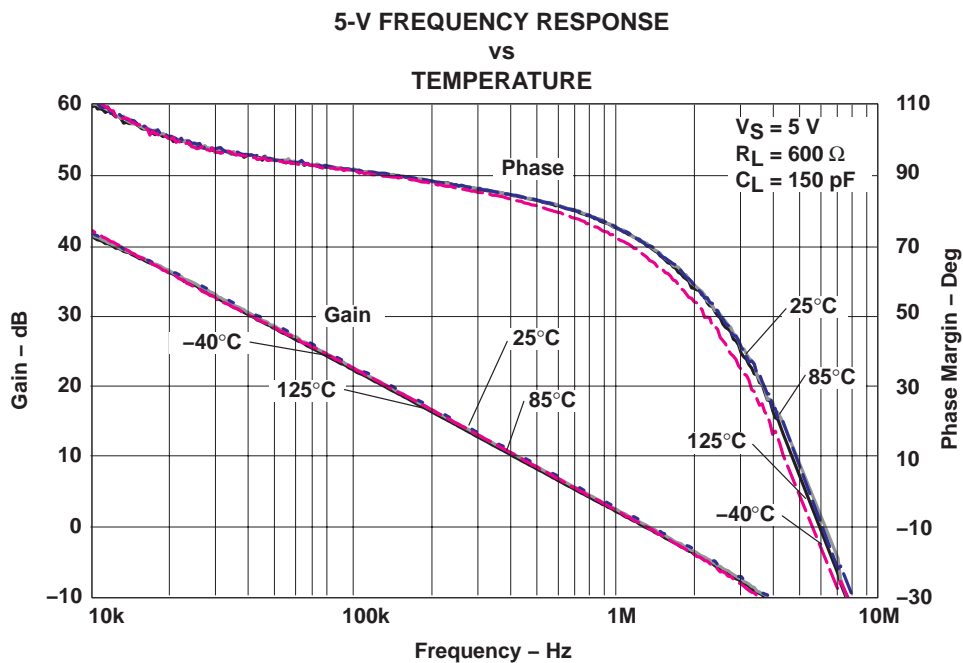

Figure 12

LMV931 SINGLE, LMV932 DUAL, LMV934 QUAD
1.8-V OPERATIONAL AMPLIFIERS
WITH RAIL-TO-RAIL INPUT AND OUTPUT

SLOS441F – AUGUST 2004 – REVISED FEBRUARY 2005

TYPICAL PERFORMANCE CHARACTERISTICS
 Unless Otherwise Specified, $V_{CC+} = 5\text{ V}$, Single Supply, $T_A = 25^\circ\text{C}$

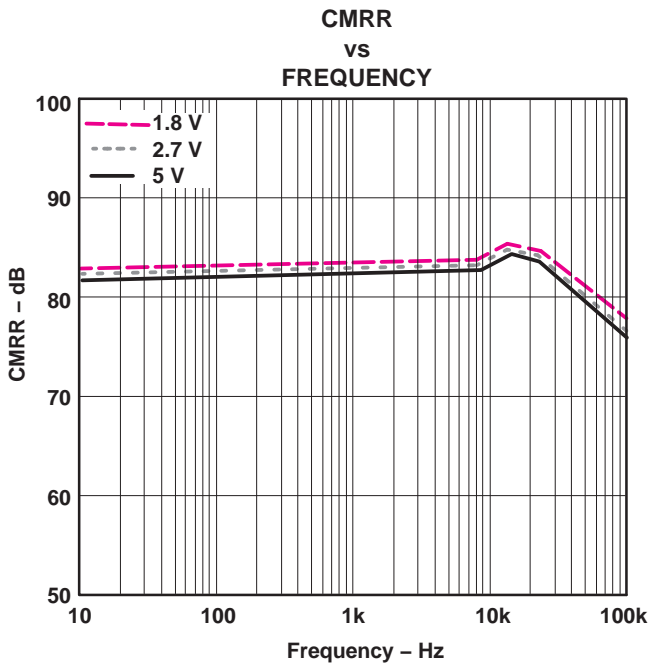

Figure 13

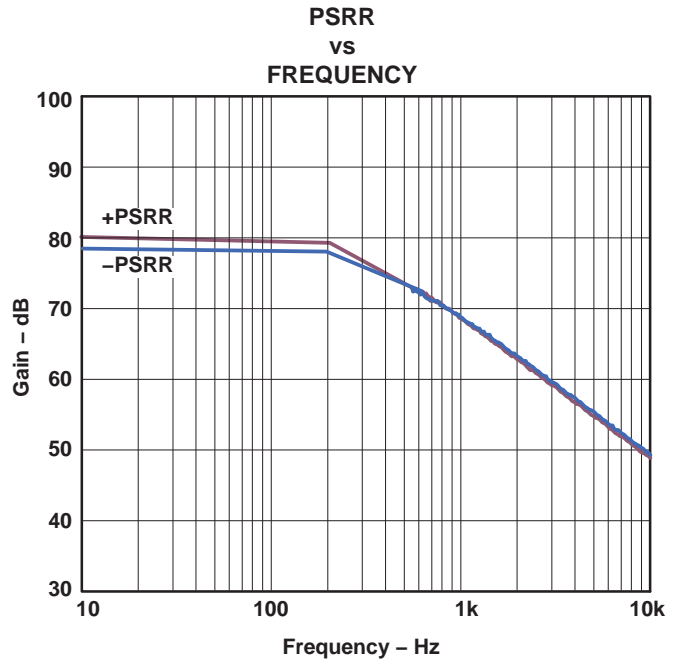

Figure 14

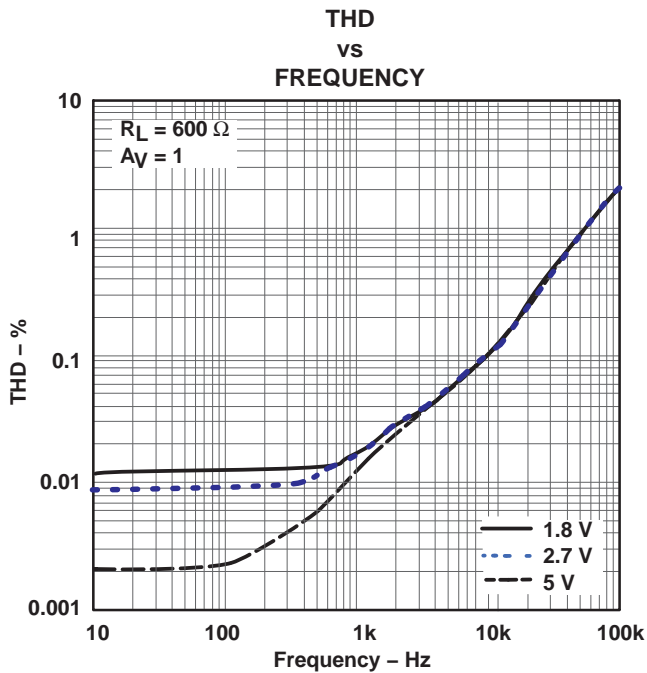

Figure 15

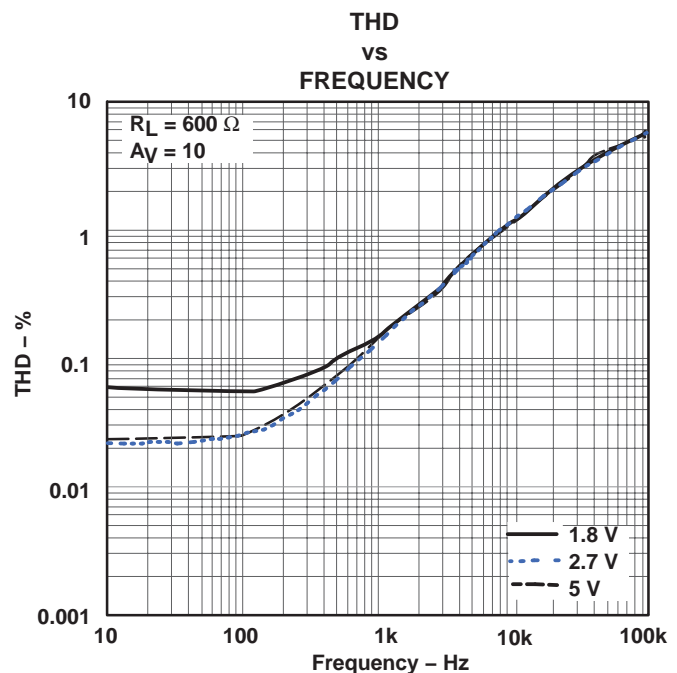

Figure 16



TYPICAL PERFORMANCE CHARACTERISTICS
Unless Otherwise Specified, $V_{CC+} = 5\text{ V}$, Single Supply, $T_A = 25^\circ\text{C}$

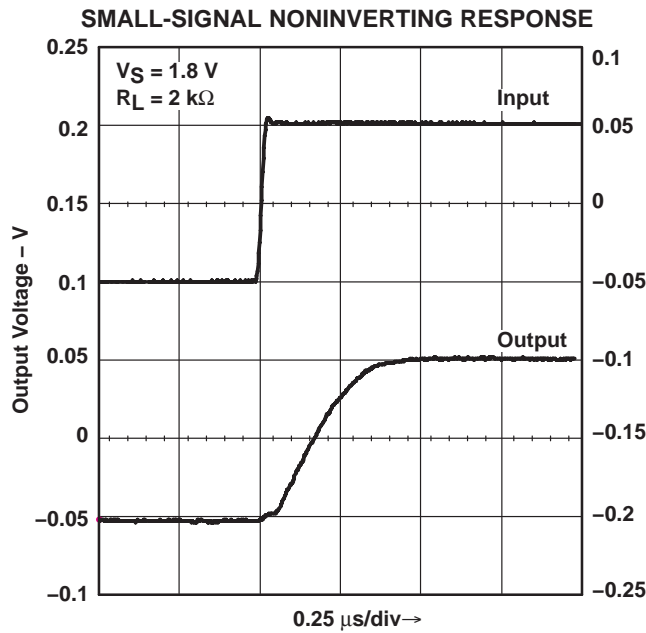

Figure 17

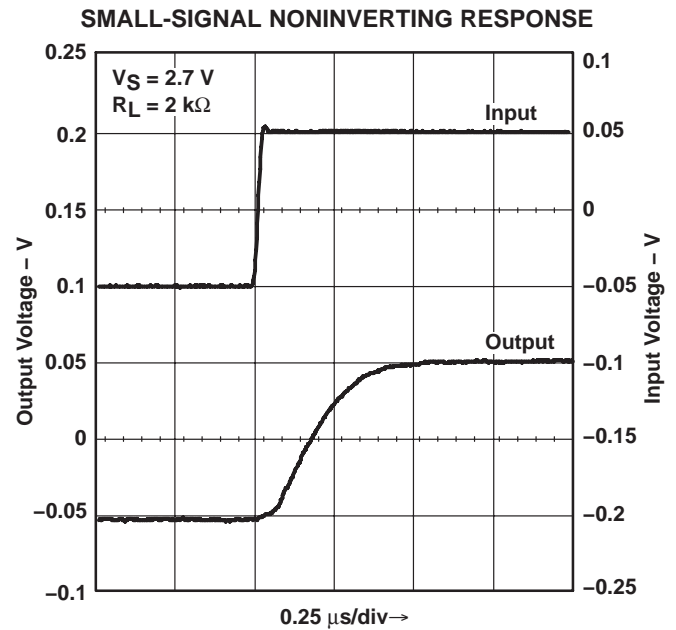

Figure 18

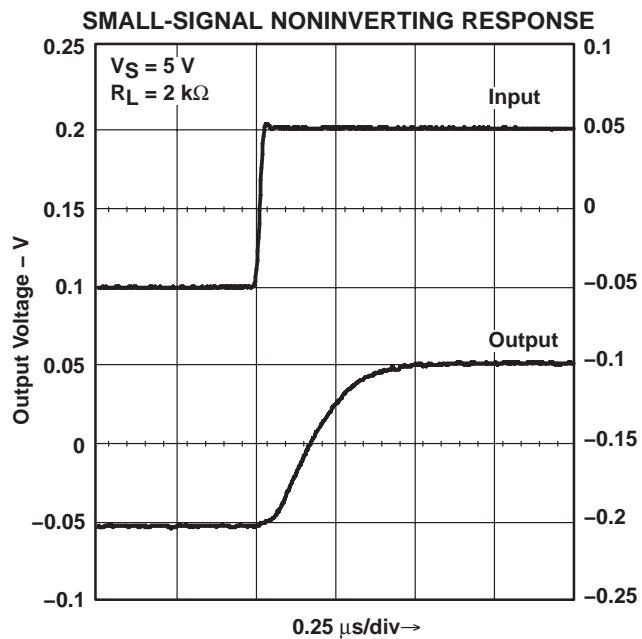

Figure 19

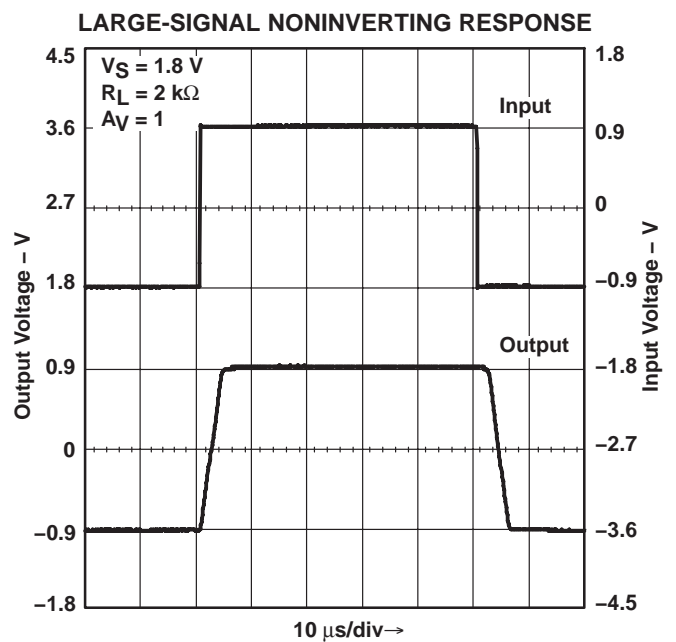

Figure 20

**LMV931 SINGLE, LMV932 DUAL, LMV934 QUAD
1.8-V OPERATIONAL AMPLIFIERS
WITH RAIL-TO-RAIL INPUT AND OUTPUT**

SLOS441F – AUGUST 2004 – REVISED FEBRUARY 2005

TYPICAL PERFORMANCE CHARACTERISTICS
Unless Otherwise Specified, $V_{CC+} = 5\text{ V}$, Single Supply, $T_A = 25^\circ\text{C}$

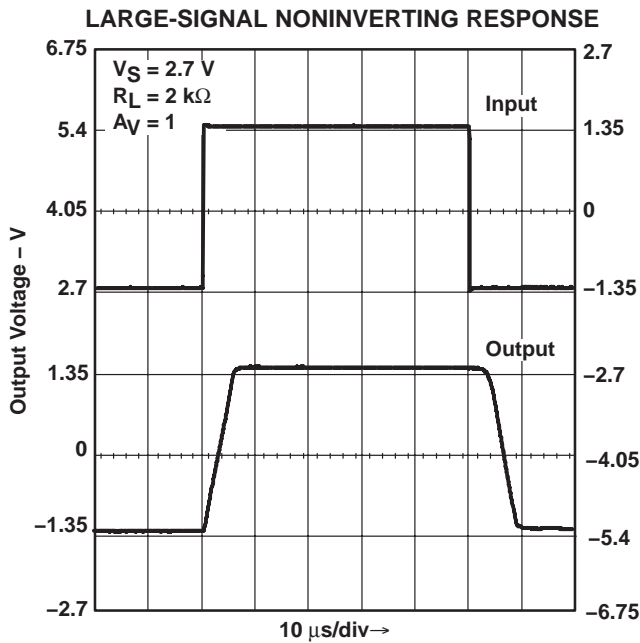

Figure 21

**OFFSET VOLTAGE
vs**

COMMON-MODE RANGE

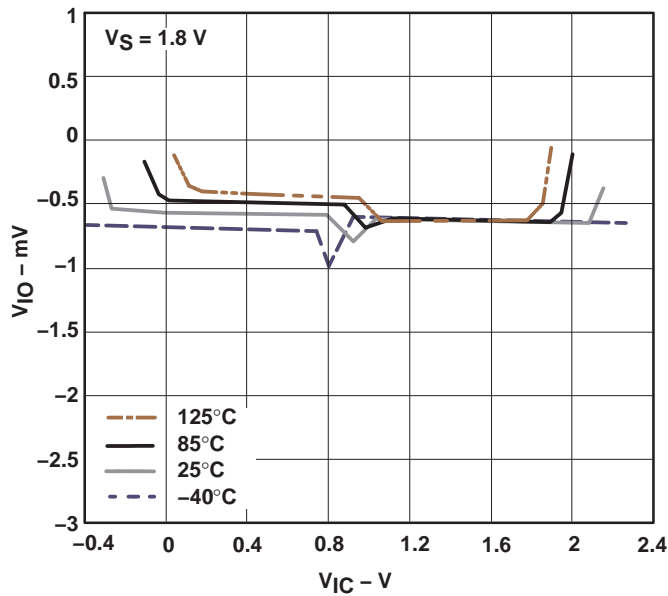

Figure 23

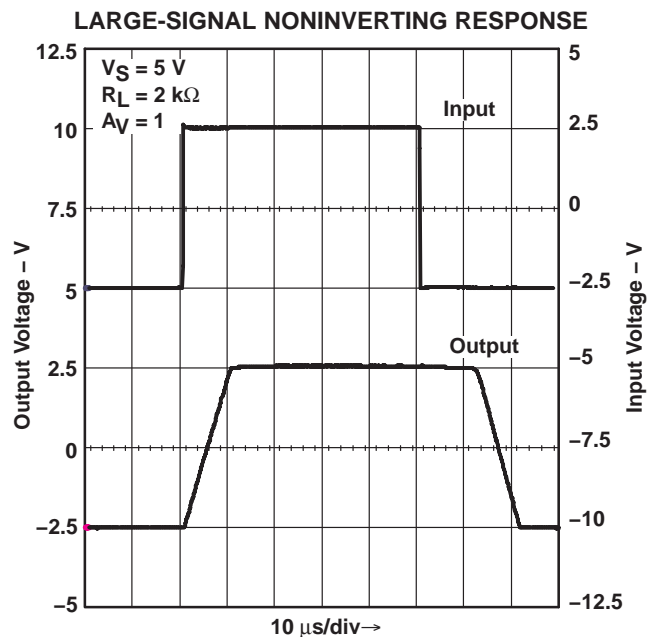

Figure 22

**OFFSET VOLTAGE
vs**

COMMON-MODE RANGE

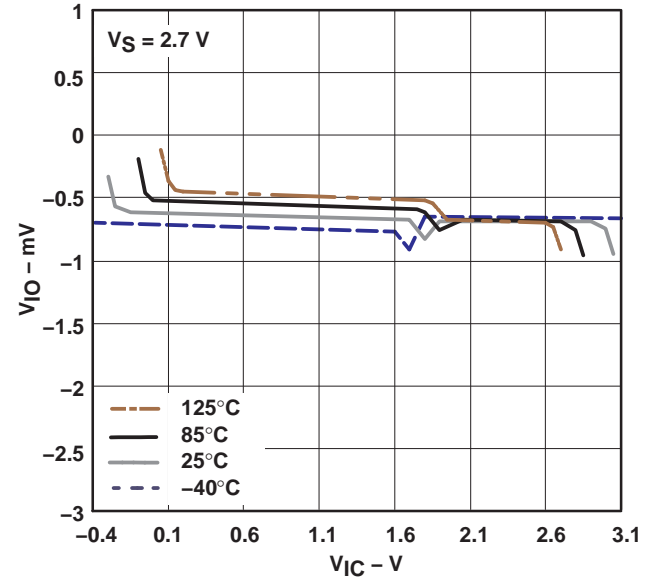
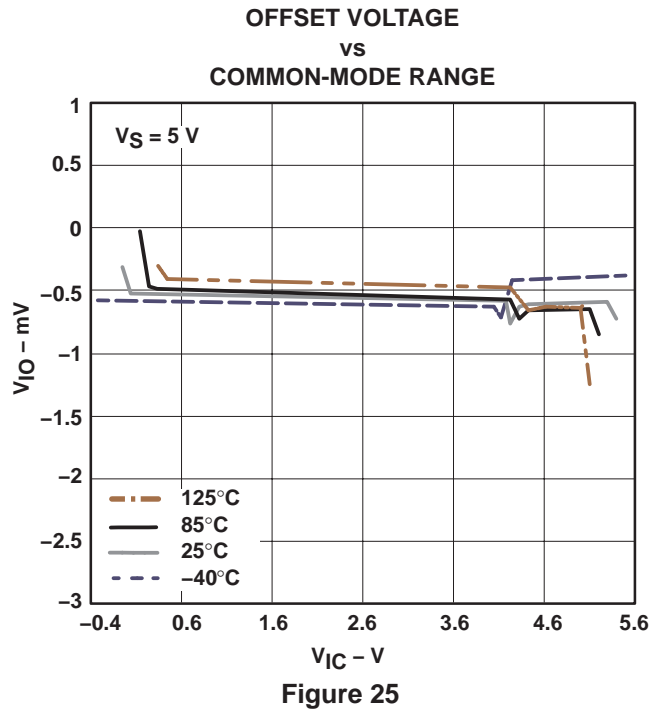

Figure 24

TYPICAL PERFORMANCE CHARACTERISTICS
Unless Otherwise Specified, $V_{CC+} = 5\text{ V}$, Single Supply, $T_A = 25^\circ\text{C}$



PACKAGING INFORMATION

Orderable Device	Status ⁽¹⁾	Package Type	Package Drawing	Pins	Package Qty	Eco Plan ⁽²⁾	Lead/Ball Finish	MSL Peak Temp ⁽³⁾
LMV931IDBVR	ACTIVE	SOT-23	DBV	5	3000	Green (RoHS & no Sb/Br)	CU NIPDAU	Level-1-260C-UNLIM
LMV931IDBvre4	ACTIVE	SOT-23	DBV	5	3000	Green (RoHS & no Sb/Br)	CU NIPDAU	Level-1-260C-UNLIM
LMV931IDCKR	ACTIVE	SC70	DCK	5	3000	Green (RoHS & no Sb/Br)	CU NIPDAU	Level-1-260C-UNLIM
LMV931IDCKRE4	ACTIVE	SC70	DCK	5	3000	Green (RoHS & no Sb/Br)	CU NIPDAU	Level-1-260C-UNLIM
LMV931IDCKRG4	ACTIVE	SC70	DCK	5	3000	Green (RoHS & no Sb/Br)	CU NIPDAU	Level-1-260C-UNLIM
LMV932ID	ACTIVE	SOIC	D	8	75	Green (RoHS & no Sb/Br)	CU NIPDAU	Level-1-260C-UNLIM
LMV932IDE4	ACTIVE	SOIC	D	8	75	Green (RoHS & no Sb/Br)	CU NIPDAU	Level-1-260C-UNLIM
LMV932IDG4	ACTIVE	SOIC	D	8	75	Green (RoHS & no Sb/Br)	CU NIPDAU	Level-1-260C-UNLIM
LMV932IDGKR	ACTIVE	MSOP	DGK	8	2500	Green (RoHS & no Sb/Br)	CU NIPDAU	Level-1-260C-UNLIM
LMV932IDR	ACTIVE	SOIC	D	8	2500	Green (RoHS & no Sb/Br)	CU NIPDAU	Level-1-260C-UNLIM
LMV932IDRE4	ACTIVE	SOIC	D	8	2500	Green (RoHS & no Sb/Br)	CU NIPDAU	Level-1-260C-UNLIM
LMV932IDRG4	ACTIVE	SOIC	D	8	2500	Green (RoHS & no Sb/Br)	CU NIPDAU	Level-1-260C-UNLIM
LMV934ID	ACTIVE	SOIC	D	14	50	Green (RoHS & no Sb/Br)	CU NIPDAU	Level-1-260C-UNLIM
LMV934IDE4	ACTIVE	SOIC	D	14	50	Green (RoHS & no Sb/Br)	CU NIPDAU	Level-1-260C-UNLIM
LMV934IDR	ACTIVE	SOIC	D	14	2500	Green (RoHS & no Sb/Br)	CU NIPDAU	Level-1-260C-UNLIM
LMV934IDRE4	ACTIVE	SOIC	D	14	2500	Green (RoHS & no Sb/Br)	CU NIPDAU	Level-1-260C-UNLIM
LMV934IPW	ACTIVE	TSSOP	PW	14	90	Green (RoHS & no Sb/Br)	CU NIPDAU	Level-1-260C-UNLIM
LMV934IPWE4	ACTIVE	TSSOP	PW	14	90	Green (RoHS & no Sb/Br)	CU NIPDAU	Level-1-260C-UNLIM
LMV934IPWR	ACTIVE	TSSOP	PW	14	2000	Green (RoHS & no Sb/Br)	CU NIPDAU	Level-1-260C-UNLIM
LMV934IPWRE4	ACTIVE	TSSOP	PW	14	2000	Green (RoHS & no Sb/Br)	CU NIPDAU	Level-1-260C-UNLIM

⁽¹⁾ The marketing status values are defined as follows:

ACTIVE: Product device recommended for new designs.

LIFEBUY: TI has announced that the device will be discontinued, and a lifetime-buy period is in effect.

NRND: Not recommended for new designs. Device is in production to support existing customers, but TI does not recommend using this part in a new design.

PREVIEW: Device has been announced but is not in production. Samples may or may not be available.

OBsolete: TI has discontinued the production of the device.

⁽²⁾ Eco Plan - The planned eco-friendly classification: Pb-Free (RoHS) or Green (RoHS & no Sb/Br) - please check <http://www.ti.com/productcontent> for the latest availability information and additional product content details.

TBD: The Pb-Free/Green conversion plan has not been defined.

Pb-Free (RoHS): TI's terms "Lead-Free" or "Pb-Free" mean semiconductor products that are compatible with the current RoHS requirements for all 6 substances, including the requirement that lead not exceed 0.1% by weight in homogeneous materials. Where designed to be soldered at high temperatures, TI Pb-Free products are suitable for use in specified lead-free processes.

Green (RoHS & no Sb/Br): TI defines "Green" to mean Pb-Free (RoHS compatible), and free of Bromine (Br) and Antimony (Sb) based flame retardants (Br or Sb do not exceed 0.1% by weight in homogeneous material)

⁽³⁾ MSL, Peak Temp. -- The Moisture Sensitivity Level rating according to the JEDEC industry standard classifications, and peak solder temperature.

Important Information and Disclaimer:The information provided on this page represents TI's knowledge and belief as of the date that it is provided. TI bases its knowledge and belief on information provided by third parties, and makes no representation or warranty as to the accuracy of such information. Efforts are underway to better integrate information from third parties. TI has taken and continues to take reasonable steps to provide representative and accurate information but may not have conducted destructive testing or chemical analysis on incoming materials and chemicals. TI and TI suppliers consider certain information to be proprietary, and thus CAS numbers and other limited information may not be available for release.

In no event shall TI's liability arising out of such information exceed the total purchase price of the TI part(s) at issue in this document sold by TI to Customer on an annual basis.

DBV (R-PDSO-G5)

PLASTIC SMALL-OUTLINE PACKAGE

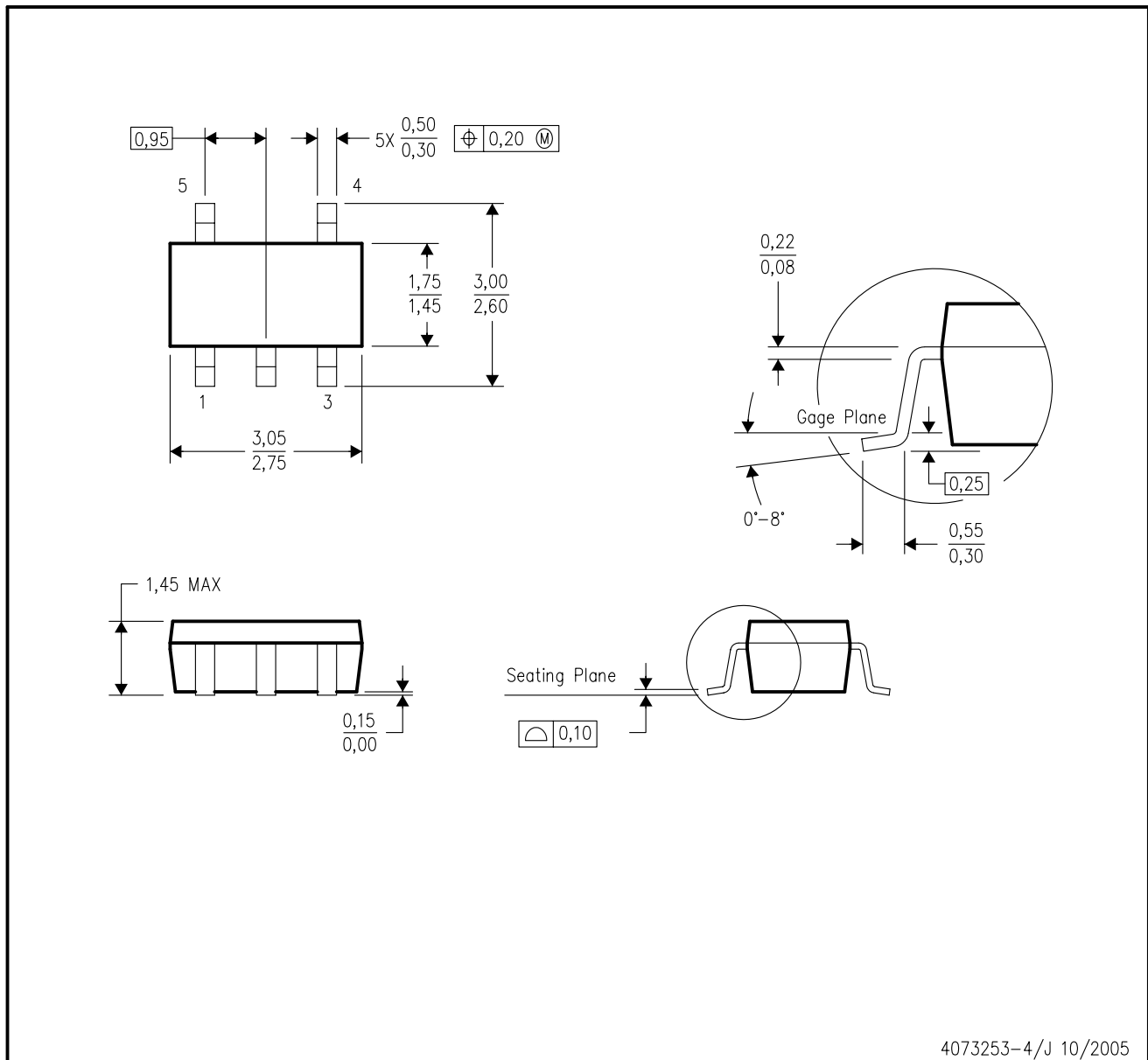

- NOTES:
- A. All linear dimensions are in millimeters.
 - B. This drawing is subject to change without notice.
 - C. Body dimensions do not include mold flash or protrusion. Mold flash and protrusion shall not exceed 0.15 per side.
 - D. Falls within JEDEC MO-178 Variation AA.

DCK (R-PDSO-G5)

PLASTIC SMALL-OUTLINE PACKAGE

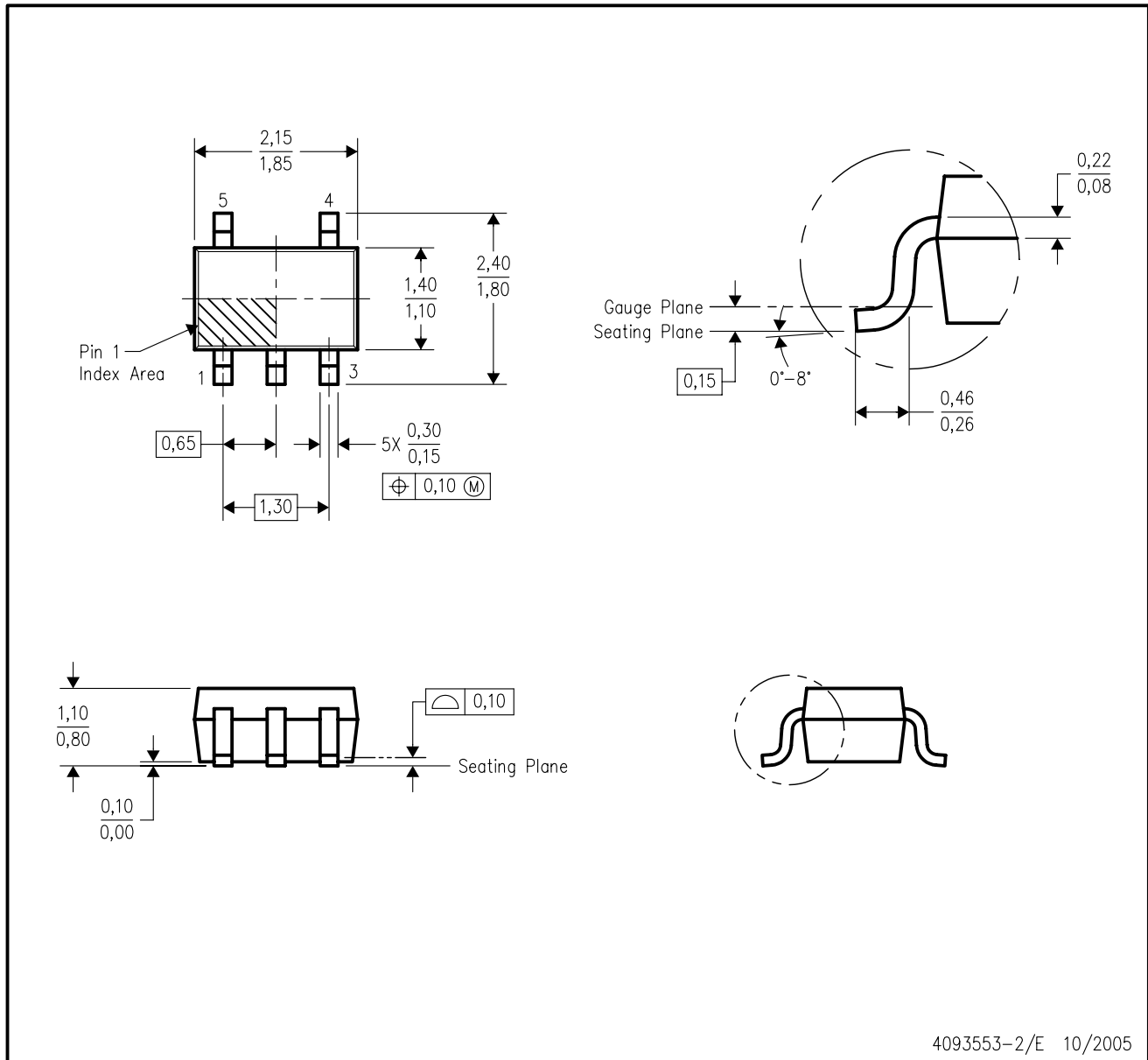

- NOTES:
- A. All linear dimensions are in millimeters.
 - B. This drawing is subject to change without notice.
 - C. Body dimensions do not include mold flash or protrusion. Mold flash and protrusion shall not exceed 0.15 per side.
 - D. Falls within JEDEC MO-203 variation AA.

DGK (S-PDSO-G8)

PLASTIC SMALL-OUTLINE PACKAGE

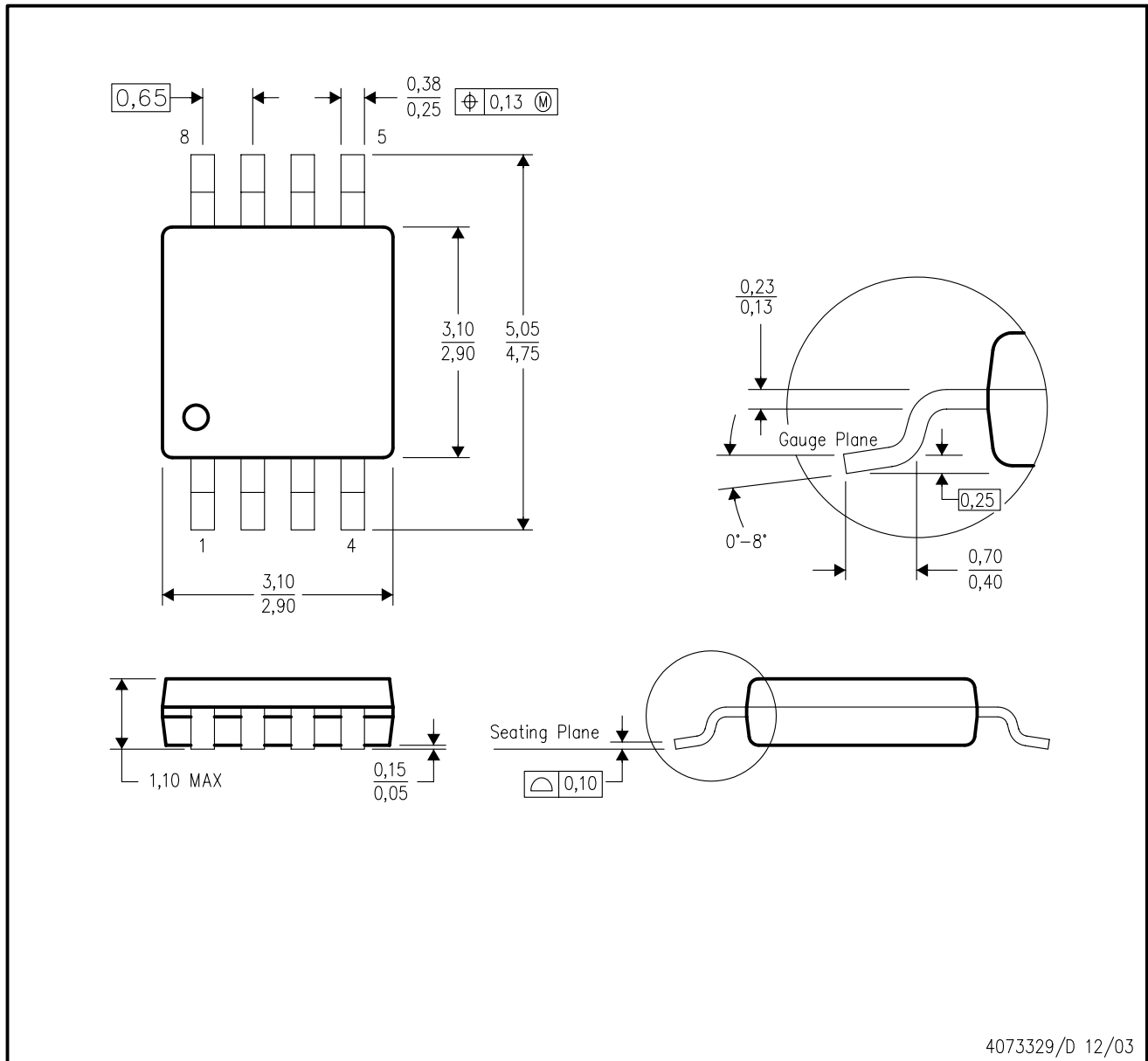

- NOTES:
- A. All linear dimensions are in millimeters.
 - B. This drawing is subject to change without notice.
 - C. Body dimensions do not include mold flash or protrusion.
 - D. Falls within JEDEC MO-187 variation AA.

D (R-PDSO-G14)

PLASTIC SMALL-OUTLINE PACKAGE

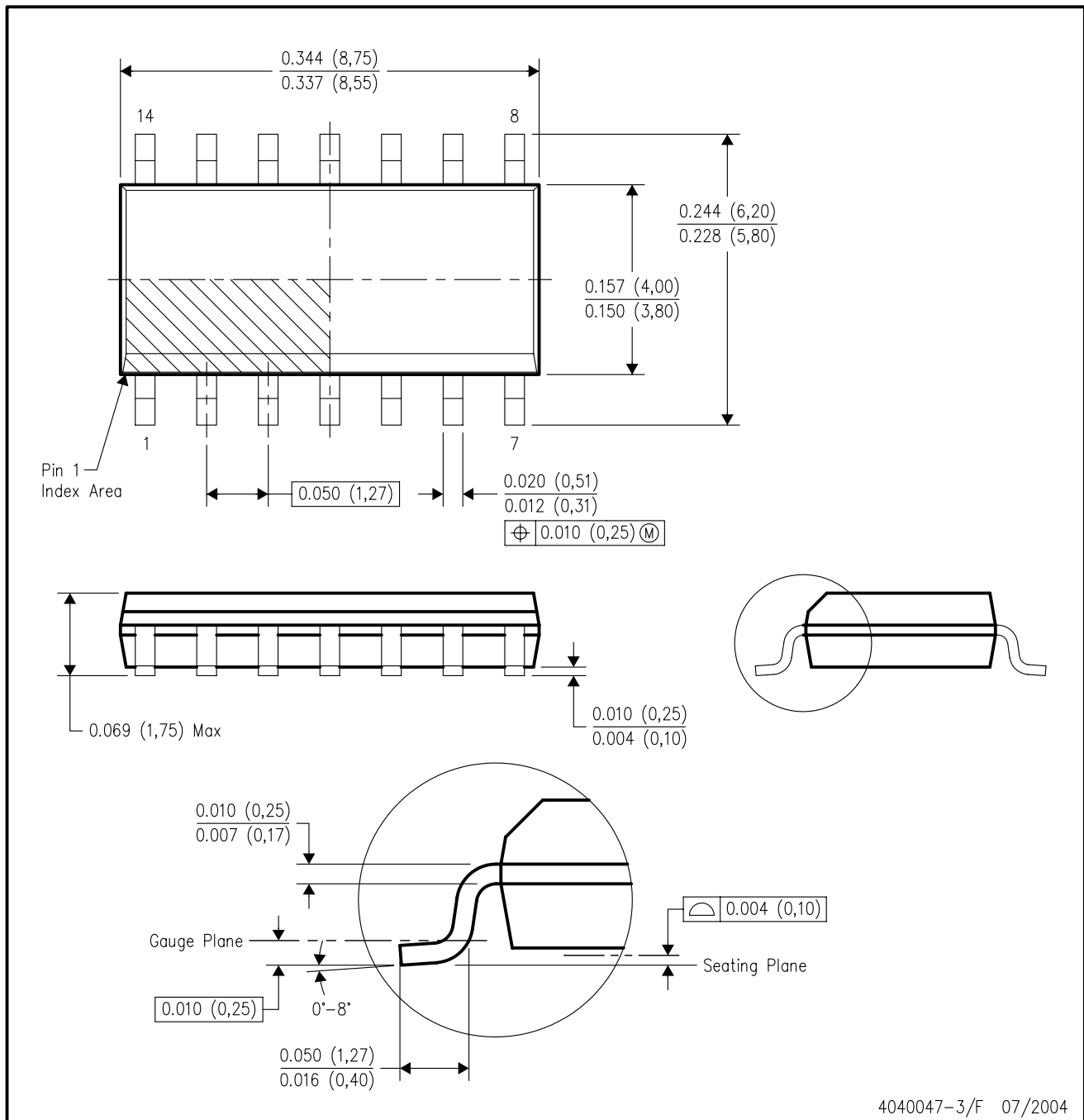

- NOTES:
- A. All linear dimensions are in inches (millimeters).
 - B. This drawing is subject to change without notice.
 - C. Body dimensions do not include mold flash or protrusion not to exceed 0.006 (0,15).
 - D. Falls within JEDEC MS-012 variation AB.

D (R-PDSO-G8)

PLASTIC SMALL-OUTLINE PACKAGE

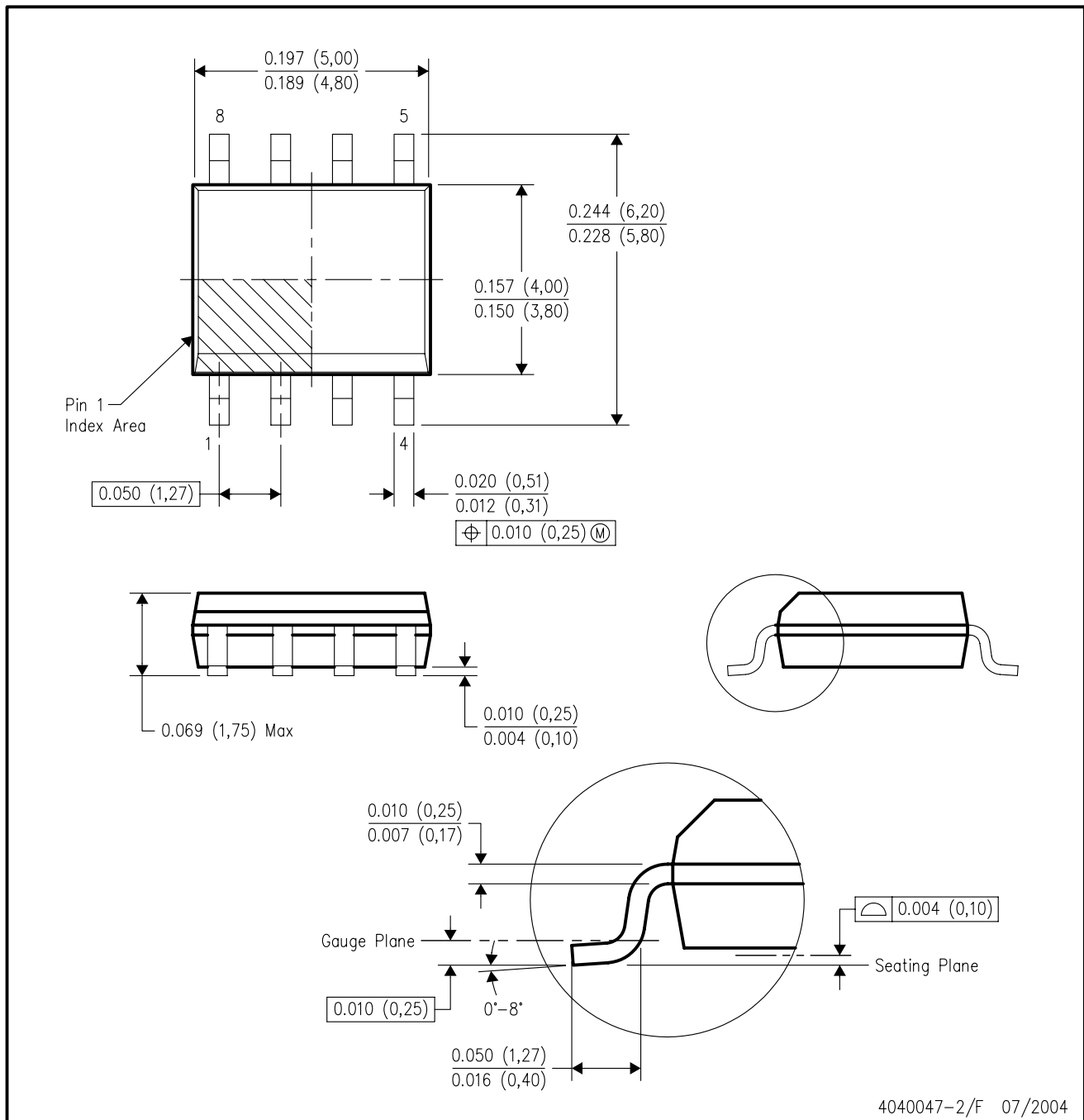

- NOTES:
- A. All linear dimensions are in inches (millimeters).
 - B. This drawing is subject to change without notice.
 - C. Body dimensions do not include mold flash or protrusion not to exceed 0.006 (0,15).
 - D. Falls within JEDEC MS-012 variation AA.

PW (R-PDSO-G**)

PLASTIC SMALL-OUTLINE PACKAGE

14 PINS SHOWN



4040064/F 01/97

- NOTES: A. All linear dimensions are in millimeters.
 B. This drawing is subject to change without notice.
 C. Body dimensions do not include mold flash or protrusion not to exceed 0,15.
 D. Falls within JEDEC MO-153

IMPORTANT NOTICE

Texas Instruments Incorporated and its subsidiaries (TI) reserve the right to make corrections, modifications, enhancements, improvements, and other changes to its products and services at any time and to discontinue any product or service without notice. Customers should obtain the latest relevant information before placing orders and should verify that such information is current and complete. All products are sold subject to TI's terms and conditions of sale supplied at the time of order acknowledgment.

TI warrants performance of its hardware products to the specifications applicable at the time of sale in accordance with TI's standard warranty. Testing and other quality control techniques are used to the extent TI deems necessary to support this warranty. Except where mandated by government requirements, testing of all parameters of each product is not necessarily performed.

TI assumes no liability for applications assistance or customer product design. Customers are responsible for their products and applications using TI components. To minimize the risks associated with customer products and applications, customers should provide adequate design and operating safeguards.

TI does not warrant or represent that any license, either express or implied, is granted under any TI patent right, copyright, mask work right, or other TI intellectual property right relating to any combination, machine, or process in which TI products or services are used. Information published by TI regarding third-party products or services does not constitute a license from TI to use such products or services or a warranty or endorsement thereof. Use of such information may require a license from a third party under the patents or other intellectual property of the third party, or a license from TI under the patents or other intellectual property of TI.

Reproduction of information in TI data books or data sheets is permissible only if reproduction is without alteration and is accompanied by all associated warranties, conditions, limitations, and notices. Reproduction of this information with alteration is an unfair and deceptive business practice. TI is not responsible or liable for such altered documentation.

Resale of TI products or services with statements different from or beyond the parameters stated by TI for that product or service voids all express and any implied warranties for the associated TI product or service and is an unfair and deceptive business practice. TI is not responsible or liable for any such statements.

Following are URLs where you can obtain information on other Texas Instruments products and application solutions:

Products		Applications	
Amplifiers	amplifier.ti.com	Audio	www.ti.com/audio
Data Converters	dataconverter.ti.com	Automotive	www.ti.com/automotive
DSP	dsp.ti.com	Broadband	www.ti.com/broadband
Interface	interface.ti.com	Digital Control	www.ti.com/digitalcontrol
Logic	logic.ti.com	Military	www.ti.com/military
Power Mgmt	power.ti.com	Optical Networking	www.ti.com/opticalnetwork
Microcontrollers	microcontroller.ti.com	Security	www.ti.com/security
		Telephony	www.ti.com/telephony
		Video & Imaging	www.ti.com/video
		Wireless	www.ti.com/wireless

Mailing Address: Texas Instruments
Post Office Box 655303 Dallas, Texas 75265