



3.0A Ultra-Low Dropout Linear Regulator

FEATURES

- Soft-Start (SS) Pin Provides a Linear Startup with Ramp Time Set by External Capacitor
- 1% Accuracy Over Line, Load, and Temperature
- Supports Input Voltages as Low as 0.9V with External Bias Supply
- Adjustable Output (0.8V to 3.6V)
- Ultra-Low Dropout: 115mV at 3.0A (typ)
- Stable with Any or No Output Capacitor
- Excellent Transient Response
- Available in 5mm × 5mm × 1mm QFN and DPAK-7 Packages
- Open-Drain Power-Good (QFN only)
- Active High Enable

APPLICATIONS

- FPGA Applications
- DSP Core and I/O Voltages
- Post-Regulation Applications
- Applications with Special Start-Up Time or Sequencing Requirements
- Hot-Swap and Inrush Controls

DESCRIPTION

The TPS74401 low-dropout (LDO) linear regulator provides an easy-to-use robust power management solution for a wide variety of applications. User-programmable soft-start minimizes stress on the input power source by reducing capacitive inrush current on start-up. The soft-start is monotonic and well-suited for powering many different types of processors and ASICs. The enable input and power-good output allow easy sequencing with external regulators. This complete flexibility permits the user to configure a solution that will meet the sequencing requirements of FPGAs, DSPs, and other applications with specific start-up requirements.

A precision reference and error amplifier deliver 1% accuracy over load, line, temperature, and process. Each LDO is stable with low-cost ceramic output capacitors and the device is fully specified from -40°C to $+125^{\circ}\text{C}$. The TPS74401 is offered in a small (5mm × 5mm) QFN package, yielding a highly compact total solution size. For applications that require additional power dissipation, the DPAK (KTW) package is also available.

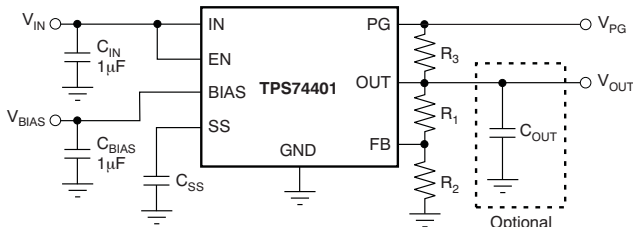

Figure 1. Typical Application Circuit

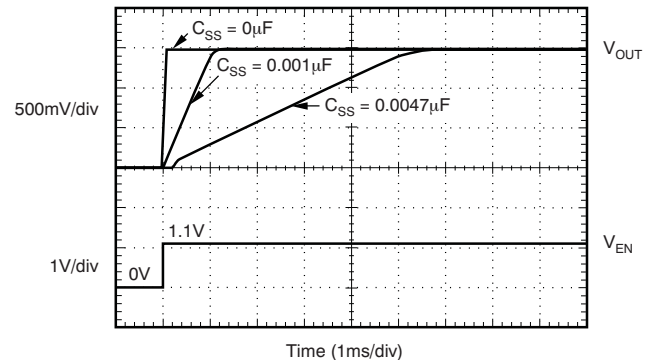

Figure 2. Turn-On Response



Please be aware that an important notice concerning availability, standard warranty, and use in critical applications of Texas Instruments semiconductor products and disclaimers thereto appears at the end of this data sheet.

All trademarks are the property of their respective owners.



This integrated circuit can be damaged by ESD. Texas Instruments recommends that all integrated circuits be handled with appropriate precautions. Failure to observe proper handling and installation procedures can cause damage.

ESD damage can range from subtle performance degradation to complete device failure. Precision integrated circuits may be more susceptible to damage because very small parametric changes could cause the device not to meet its published specifications.

ORDERING INFORMATION⁽¹⁾

PRODUCT	V _{OUT} ⁽²⁾
TPS744xxyyyzz	XX is nominal output voltage (for example, 12 = 1.2V, 15 = 1.5V, 01 = Adjustable). ⁽³⁾ YYY is package designator. Z is package quantity.

- (1) For the most current package and ordering information see the Package Option Addendum at the end of this document, or see the TI website at www.ti.com.
- (2) Output voltages from 0.9V to 1.5V in 50mV increments and 1.5V to 3.6V in 100mV increments are available through the use of innovative factory EEPROM programming; minimum order quantities may apply. Contact factory for details and availability.
- (3) For fixed 0.8V operation, tie FB to OUT.

ABSOLUTE MAXIMUM RATINGS⁽¹⁾

At T_J = –40°C to +125°C, unless otherwise noted. All voltages are with respect to GND.

	TPS74401	UNIT
V _{IN} , V _{BIAS} input voltage range	–0.3 to +6	V
V _{EN} enable voltage range	–0.3 to +6	V
V _{PG} power-good voltage range	–0.3 to +6	V
V _{SS} SS pin voltage range	–0.3 to +6	V
V _{FB} feedback pin voltage range	–0.3 to +6	V
V _{OUT} output voltage range	–0.3 to V _{IN} + 0.3	V
I _{OUT} maximum output current	Internally limited	
Output short circuit duration	Indefinite	
P _{DISS} continuous total power dissipation	See Dissipation Ratings Table	
T _J operating junction temperature range	–40 to +125	°C
T _{STG} storage junction temperature range	–55 to +150	°C

- (1) Stresses beyond those listed under *Absolute Maximum Ratings* may cause permanent damage to the device. These are stress ratings only and functional operation of the device at these conditions is not implied. Exposure to absolute-maximum-rated conditions for extended periods may affect device reliability.

DISSIPATION RATINGS

PACKAGE	θ _{JA}	θ _{JC}	T _A < +25°C POWER RATING	DERATING FACTOR ABOVE T _A = +25°C
RGW (QFN) ⁽¹⁾	36.5°C/W	4.05°C/W	2.74W	27.4mW/°C
KTW (DDPAK) ⁽²⁾	18.8°C/W	2.32°C/W	5.32W	53.2mW/°C

- (1) See [Figure 32](#) for PCB layout description.
- (2) See [Figure 35](#) for PCB layout description.

ELECTRICAL CHARACTERISTICS

At $V_{EN} = 1.1V$, $V_{IN} = V_{OUT} + 0.3V$, $C_{IN} = C_{BIAS} = 0.1\mu F$, $C_{OUT} = 10\mu F$, $I_{OUT} = 50mA$, $V_{BIAS} = 5.0V$, and $T_J = -40^\circ C$ to $+125^\circ C$, unless otherwise noted. Typical values are at $T_J = +25^\circ C$.

PARAMETER	TEST CONDITIONS	TPS74401			UNIT	
		MIN	TYP	MAX		
V_{IN}	Input voltage range	$V_{OUT} + V_{DO}$			V	
V_{BIAS}	Bias pin voltage range	2.375		5.25	V	
V_{REF}	Internal reference (Adj.)	$T_J = +25^\circ C$	0.796	0.8	0.804	V
V_{OUT}	Output voltage range	$V_{IN} = 5V$, $I_{OUT} = 1.5A$, $V_{BIAS} = 5V$	V_{REF}		3.6	V
	Accuracy ⁽¹⁾	$2.97V \leq V_{BIAS} \leq 5.25V$, $50mA \leq I_{OUT} \leq 3.0A$	-1	± 0.2	+1	%
V_{OUT}/V_{IN}	Line regulation	$V_{OUT(NOM)} + 0.3 \leq V_{IN} \leq 5.5V$, QFN		0.0005	0.05	%V
		$V_{OUT(NOM)} + 0.3 \leq V_{IN} \leq 5.5V$, DDPAK		0.0005	0.06	
V_{OUT}/I_{OUT}	Load regulation	$0mA \leq I_{OUT} \leq 50mA$		0.013		%mA
		$50mA \leq I_{OUT} \leq 3.0A$		0.03		%A
V_{DO}	V_{IN} dropout voltage ⁽²⁾	$I_{OUT} = 3.0A$, $V_{BIAS} - V_{OUT(NOM)} \geq 1.62V$, QFN		115	195	mV
		$I_{OUT} = 3.0A$, $V_{BIAS} - V_{OUT(NOM)} \geq 1.62V$, DDPAK		120	240	
	V_{BIAS} dropout voltage ⁽²⁾	$I_{OUT} = 3.0A$, $V_{IN} = V_{BIAS}$			1.62	V
I_{CL}	Current limit	$V_{OUT} = 80\% \times V_{OUT(NOM)}$, QFN	3.8		6.0	A
		$V_{OUT} = 80\% \times V_{OUT(NOM)}$, DDPAK	3.5		6.0	
I_{BIAS}	Bias pin current	$I_{OUT} = 0mA$ to $3.0A$		2	4	mA
I_{SHDN}	Shutdown supply current (V_{IN})	$V_{EN} \leq 0.4V$		1	100	μA
I_{FB}	Feedback pin current ⁽³⁾	$I_{OUT} = 50mA$ to $3.0A$	-250	95	250	nA
PSRR	Power-supply rejection (V_{IN} to V_{OUT})	1kHz, $I_{OUT} = 1.5A$, $V_{IN} = 1.8V$, $V_{OUT} = 1.5V$		73		dB
		800kHz, $I_{OUT} = 1.5A$, $V_{IN} = 1.8V$, $V_{OUT} = 1.5V$		42		
	Power-supply rejection (V_{BIAS} to V_{OUT})	1kHz, $I_{OUT} = 1.5A$, $V_{IN} = 1.8V$, $V_{OUT} = 1.5V$		62		dB
		800kHz, $I_{OUT} = 1.5A$, $V_{IN} = 1.8V$, $V_{OUT} = 1.5V$		50		
Noise	Output noise voltage	100Hz to 100kHz, $I_{OUT} = 1.5A$, $C_{SS} = 0.001\mu F$		$16 \times V_{OUT}$		μV_{RMS}
V_{TRAN}	% V_{OUT} droop during load transient	$I_{OUT} = 100mA$ to $3.0A$ at $1A/\mu s$, $C_{OUT} = 0\mu F$		4		% V_{OUT}
t_{STR}	Minimum startup time	$I_{OUT} = 1.5A$, $C_{SS} = open$		100		μs
I_{SS}	Soft-start charging current	$V_{SS} = 0.4V$	0.5	0.73	1	μA
$V_{EN, HI}$	Enable input high level		1.1		5.5	V
$V_{EN, LO}$	Enable input low level		0		0.4	V
$V_{EN, HYS}$	Enable pin hysteresis			50		mV
$V_{EN, DG}$	Enable pin deglitch time			20		μs
I_{EN}	Enable pin current	$V_{EN} = 5V$		0.1	1	μA
V_{IT}	PG trip threshold	V_{OUT} decreasing	86.5	90	93.5	% V_{OUT}
V_{HYS}	PG trip hysteresis			3		% V_{OUT}
$V_{PG, LO}$	PG output low voltage	$I_{PG} = 1mA$ (sinking), $V_{OUT} < V_{IT}$			0.3	V
$I_{PG, LKG}$	PG leakage current	$V_{PG} = 5.25V$, $V_{OUT} > V_{IT}$		0.03	1	μA
T_J	Operating junction temperature		-40		+125	$^\circ C$
T_{SD}	Thermal shutdown temperature	Shutdown, temperature increasing		+155		$^\circ C$
		Reset, temperature decreasing		+140		

(1) Adjustable devices tested at 0.8V; external resistor tolerance is not taken into account.

(2) Dropout is defined as the voltage from the input to V_{OUT} when V_{OUT} is 2% below nominal.

(3) I_{FB} current flow is out of the device.

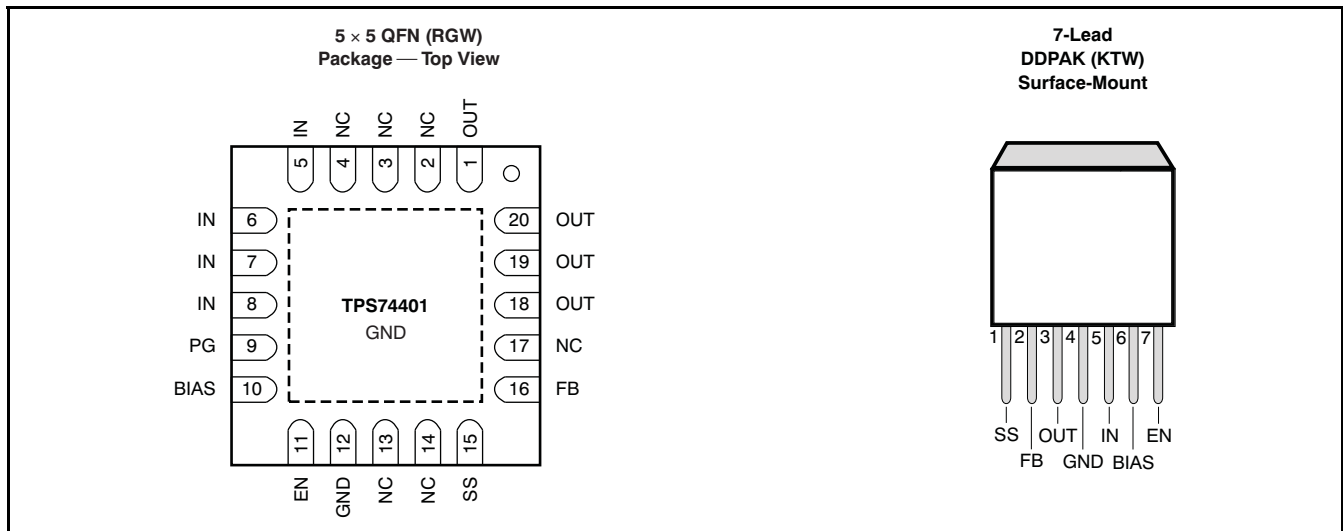

PIN DESCRIPTIONS

NAME	KTW (DDPAK)	RGW (QFN)	DESCRIPTION
IN	5	5–8	Unregulated input to the device.
EN	7	11	Enable pin. Driving this pin high enables the regulator. Driving this pin low puts the regulator into shutdown mode. This pin must not be left floating.
SS	1	15	Soft-Start pin. A capacitor connected on this pin to ground sets the start-up time. If this pin is left floating, the regulator output soft-start ramp time is typically 100 μ s.
BIAS	6	10	Bias input voltage for error amplifier, reference, and internal control circuits.
PG	N/A	9	Power-Good (PG) is an open-drain, active-high output that indicates the status of V_{OUT} . When V_{OUT} exceeds the PG trip threshold, the PG pin goes into a high-impedance state. When V_{OUT} is below this threshold the pin is driven to a low-impedance state. A pull-up resistor from 10k Ω to 1M Ω should be connected from this pin to a supply up to 5.5V. The supply can be higher than the input voltage. Alternatively, the PG pin can be left floating if output monitoring is not necessary.
FB	2	16	This pin is the feedback connection to the center tap of an external resistor divider network that sets the output voltage. This pin must not be left floating.
OUT	3	1, 18–20	Regulated output voltage. No capacitor is required on this pin for stability.
NC	N/A	2–4, 13, 14, 17	No connection. This pin can be left floating or connected to GND to allow better thermal contact to the top-side plane.
GND	4	12	Ground
PAD/TAB			Should be soldered to the ground plane for increased thermal performance.

TYPICAL CHARACTERISTICS

At $T_J = +25^\circ\text{C}$, $V_{OUT} = 1.5\text{V}$, $V_{IN} = V_{OUT(TYP)} + 0.3\text{V}$, $V_{BIAS} = 3.3\text{V}$, $I_{OUT} = 50\text{mA}$, $C_{IN} = 1\mu\text{F}$, $C_{BIAS} = 1\mu\text{F}$, $C_{SS} = 0.01\mu\text{F}$, and $C_{OUT} = 10\mu\text{F}$, unless otherwise noted.

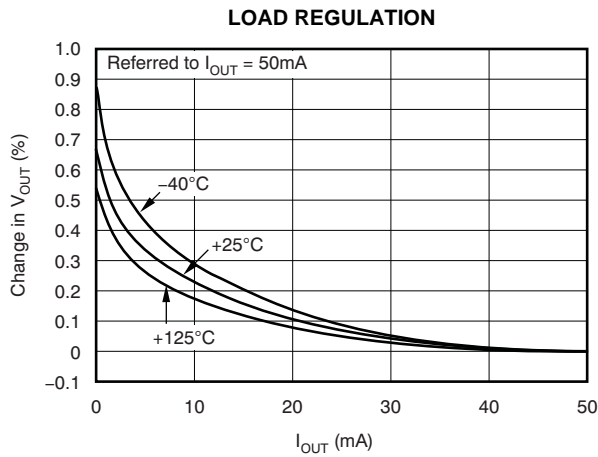

Figure 3.

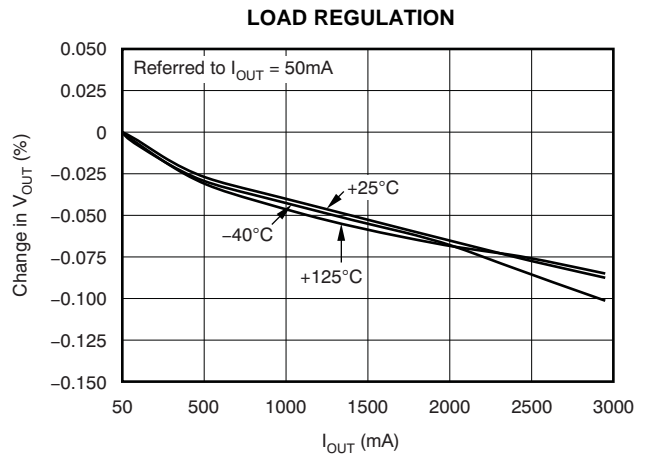

Figure 4.

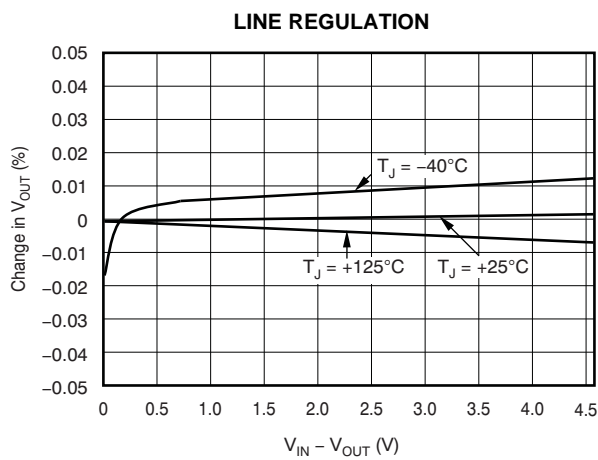

Figure 5.

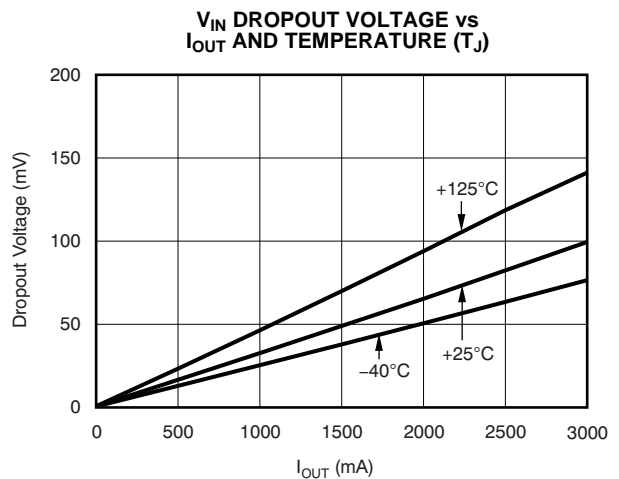

Figure 6.

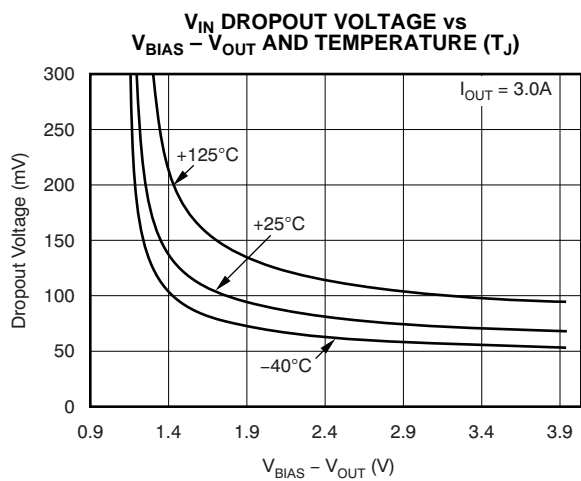

Figure 7.

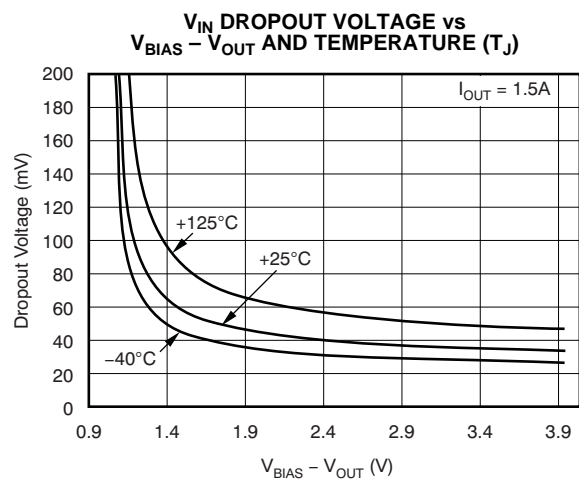

Figure 8.

TYPICAL CHARACTERISTICS (continued)

At $T_J = +25^\circ\text{C}$, $V_{OUT} = 1.5\text{V}$, $V_{IN} = V_{OUT(TYP)} + 0.3\text{V}$, $V_{BIAS} = 3.3\text{V}$, $I_{OUT} = 50\text{mA}$, $C_{IN} = 1\mu\text{F}$, $C_{BIAS} = 1\mu\text{F}$, $C_{SS} = 0.01\mu\text{F}$, and $C_{OUT} = 10\mu\text{F}$, unless otherwise noted.

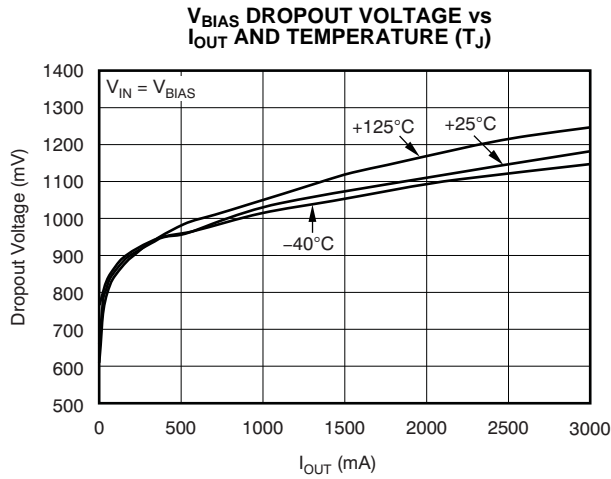

Figure 9.

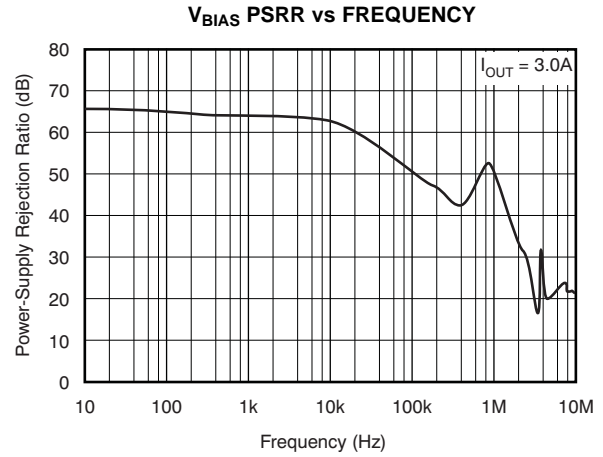

Figure 10.

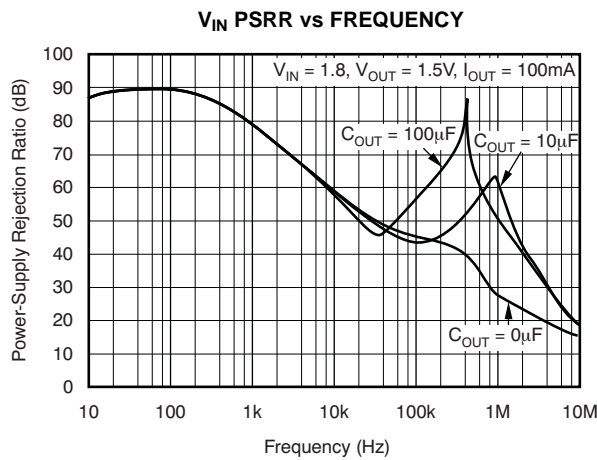

Figure 11.

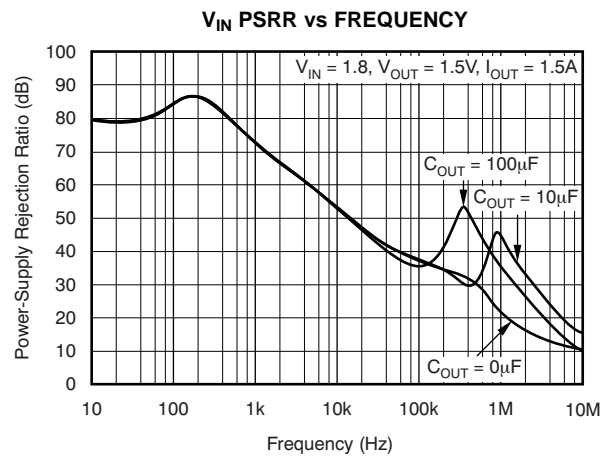

Figure 12.

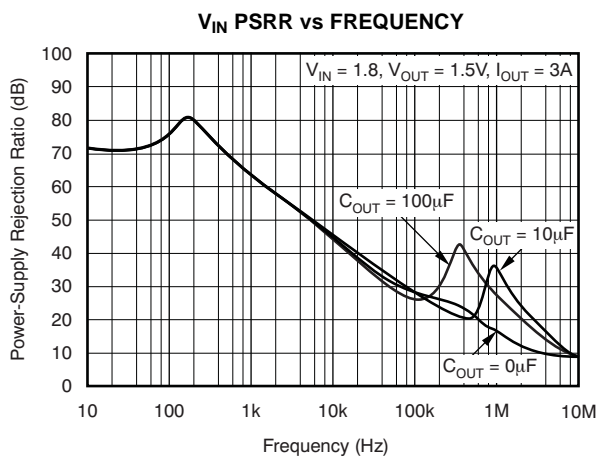

Figure 13.

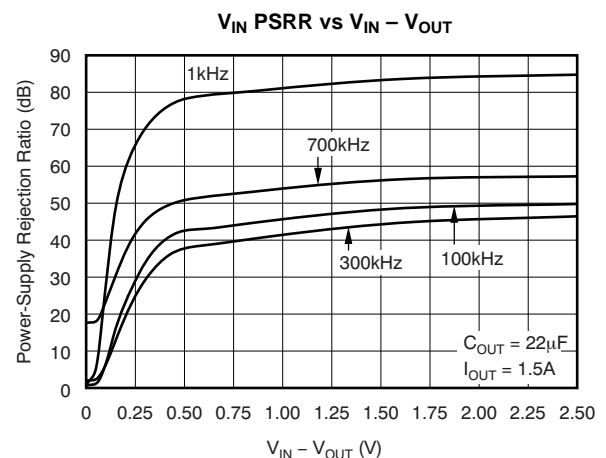

Figure 14.

TYPICAL CHARACTERISTICS (continued)

At $T_J = +25^\circ\text{C}$, $V_{OUT} = 1.5\text{V}$, $V_{IN} = V_{OUT(TYP)} + 0.3\text{V}$, $V_{BIAS} = 3.3\text{V}$, $I_{OUT} = 50\text{mA}$, $C_{IN} = 1\mu\text{F}$, $C_{BIAS} = 1\mu\text{F}$, $C_{SS} = 0.01\mu\text{F}$, and $C_{OUT} = 10\mu\text{F}$, unless otherwise noted.

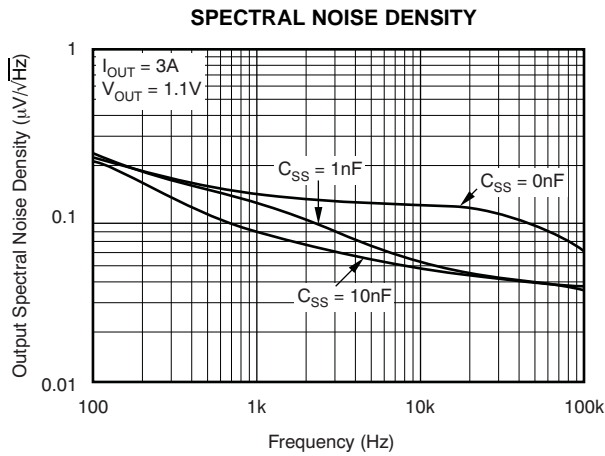

Figure 15.

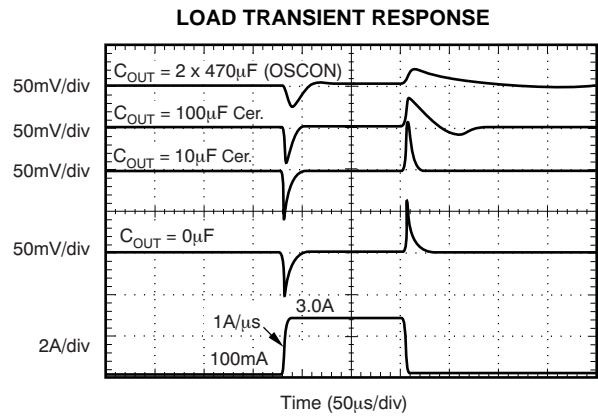

Figure 16.

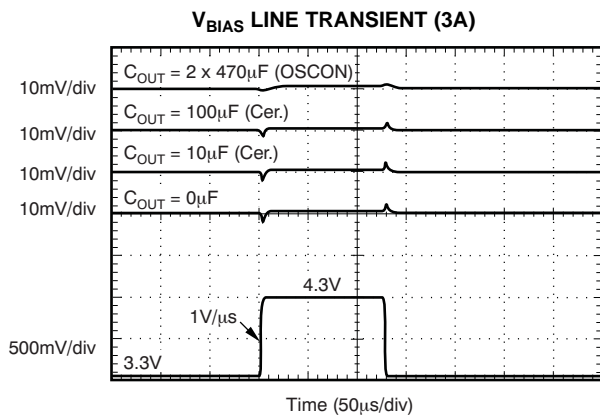

Figure 17.

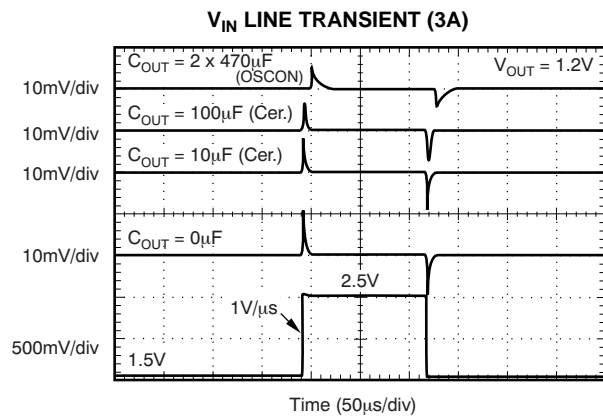

Figure 18.

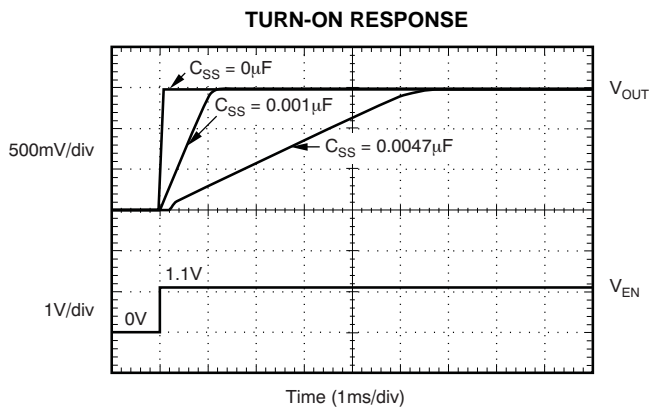

Figure 19.

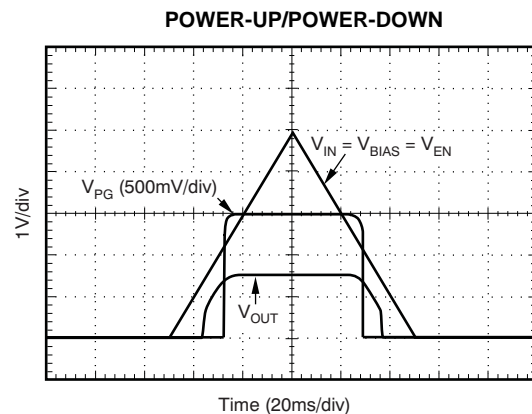

Figure 20.

TYPICAL CHARACTERISTICS (continued)

At $T_J = +25^\circ\text{C}$, $V_{\text{OUT}} = 1.5\text{V}$, $V_{\text{IN}} = V_{\text{OUT(TYP)}} + 0.3\text{V}$, $V_{\text{BIAS}} = 3.3\text{V}$, $I_{\text{OUT}} = 50\text{mA}$, $C_{\text{IN}} = 1\mu\text{F}$, $C_{\text{BIAS}} = 1\mu\text{F}$, $C_{\text{SS}} = 0.01\mu\text{F}$, and $C_{\text{OUT}} = 10\mu\text{F}$, unless otherwise noted.

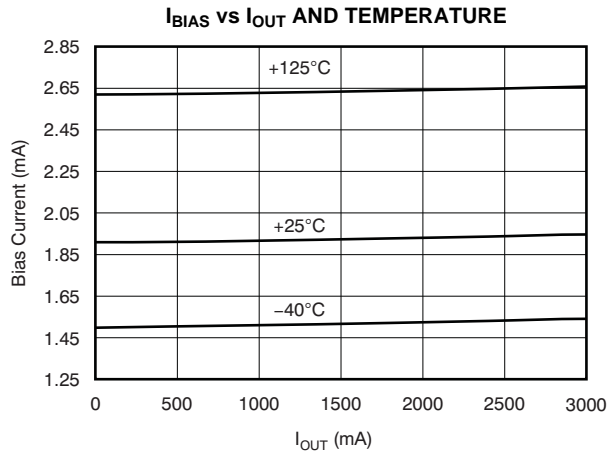

Figure 21.

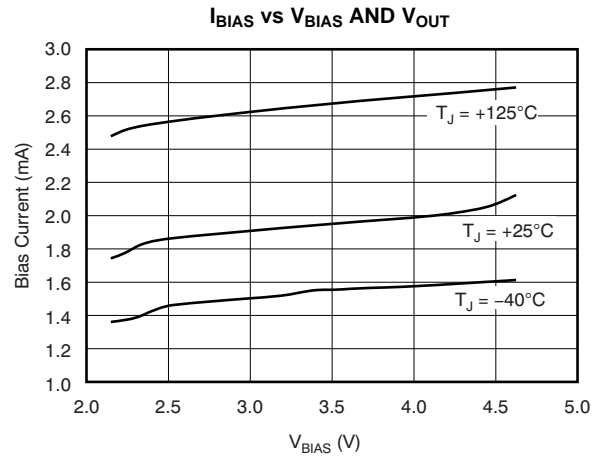

Figure 22.

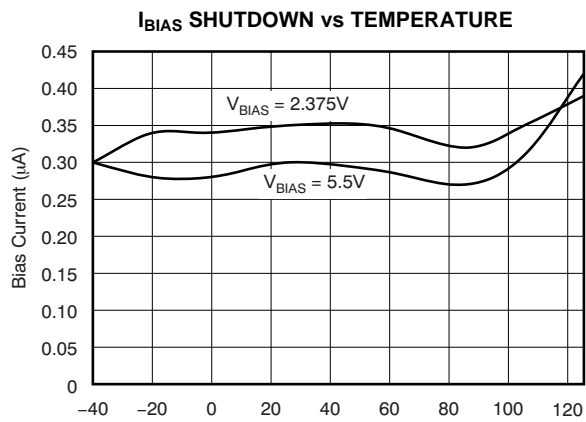

Figure 23.

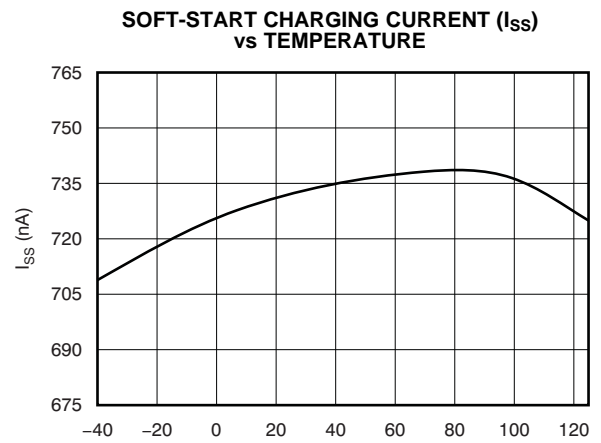

Figure 24.

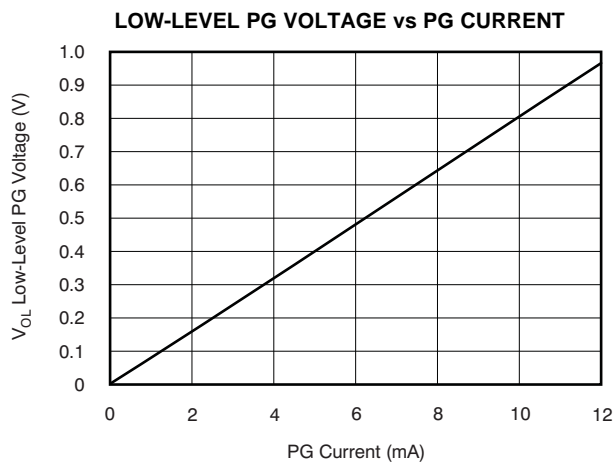

Figure 25.

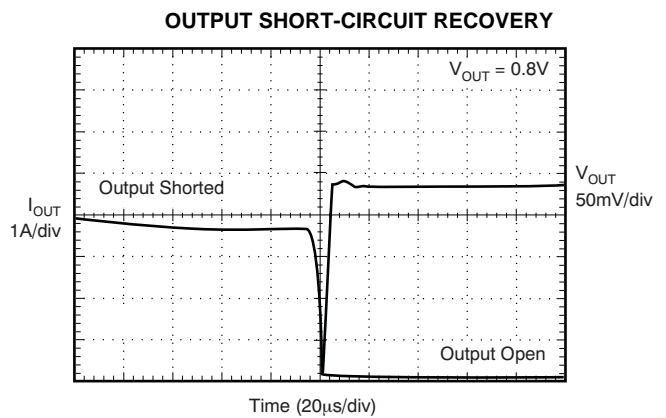

Figure 26.

APPLICATION INFORMATION

The TPS74401 belongs to a family of new generation ultra-low dropout regulators that feature soft-start and tracking capabilities. These regulators use a low current bias input to power all internal control circuitry, allowing the NMOS pass transistor to regulate very low input and output voltages.

The use of an NMOS-pass FET offers several critical advantages for many applications. Unlike a PMOS topology device, the output capacitor has little effect on loop stability. This architecture allows the TPS74401 to be stable with any or even no output capacitor. Transient response is also superior to PMOS topologies, particularly for low V_{IN} applications.

The TPS74401 features a programmable, voltage-controlled soft-start circuit that provides a smooth, monotonic start-up and limits startup inrush currents that may be caused by large capacitive loads. A power-good (PG) output is available to allow supply monitoring and sequencing of other supplies. An enable (EN) pin with hysteresis and deglitch allows slow-ramping signals to be used for sequencing the device. The low V_{IN} and V_{OUT} capability allows for inexpensive, easy-to-design, and efficient linear regulation between the multiple supply voltages often present in processor intensive systems.

Figure 27 illustrates a typical application circuit for the TPS74401 adjustable input device.

R_1 and R_2 can be calculated for any output voltage using the formula shown in Figure 27. Refer to Table 1 for sample resistor values of common output voltages. In order to achieve the maximum accuracy specifications, R_2 should be $\leq 4.99\text{k}\Omega$.

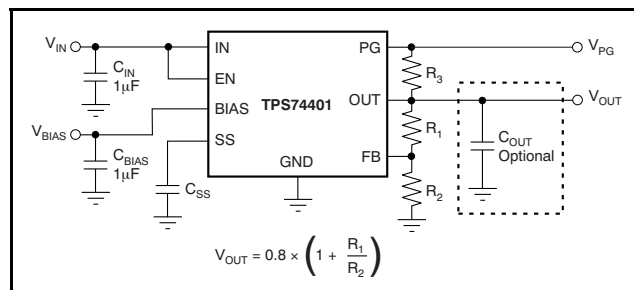

Figure 27. Typical Application Circuit for the TPS74401 (Adjustable)

INPUT, OUTPUT, AND BIAS CAPACITOR REQUIREMENTS

The device does not require any output capacitor for stability. If an output capacitor is needed, the device is designed to be stable for all available types and values of output capacitance. The device is also stable with multiple capacitors in parallel, of any type or value.

The capacitance required on the IN and BIAS pins strongly depends on the input supply source impedance. To counteract any inductance in the input, the minimum recommended capacitor for V_{IN} and V_{BIAS} is $1\mu\text{F}$. If V_{IN} and V_{BIAS} are connected to the same supply, the recommended minimum capacitor for V_{BIAS} is $4.7\mu\text{F}$. Good quality, low ESR capacitors should be used on the input; ceramic X5R and X7R capacitors are preferred. These capacitors should be placed as close the pins as possible for optimum performance.

TRANSIENT RESPONSE

The TPS74401 was designed to have transient response within 5% for most applications without any output capacitor. In some cases, the transient response may be limited by the transient response of the input supply. This limitation is especially true in applications where the difference between the input and output is less than 300mV. In this case, adding additional input capacitance improves the transient response much more than just adding additional output capacitance. With a solid input supply, adding additional output capacitance reduces undershoot and overshoot during a transient at the expense of a slightly longer V_{OUT} recovery time. Refer to Figure 16 in the Typical Characteristics section. Since the TPS74401 is stable without an output capacitor, many applications may allow for little or no capacitance at the LDO output. For these applications, local bypass capacitance for the device under power may be sufficient to meet the transient requirements of the application. This design reduces the total solution cost by avoiding the need to use expensive high-value capacitors at the LDO output.

DROPOUT VOLTAGE

The TPS74401 offers industry-leading dropout performance, making it well-suited for high-current low V_{IN} /low V_{OUT} applications. The extremely low dropout of the TPS74401 allows the device to be used in place of a DC/DC converter and still achieve good efficiencies. This efficiency allows users to rethink the power architecture for their applications to achieve the smallest, simplest, and lowest cost solution.

There are two different specifications for dropout voltage with the TPS74401. The first specification (see [Figure 28](#)) is referred to as V_{IN} Dropout and is for users that wish to apply an external bias voltage to achieve low dropout. This specification assumes that V_{BIAS} is at least 1.62V above V_{OUT} , which is the case for V_{BIAS} when powered by a 3.3V rail with 5% tolerance and with $V_{OUT} = 1.5V$. If V_{BIAS} is higher than $3.3V \times 0.95$ or V_{OUT} is less than 1.5V, V_{IN} dropout is less than specified.

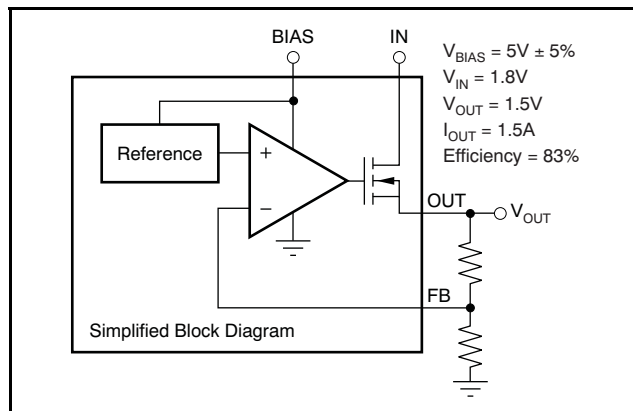

Figure 28. Typical Application of the TPS74401 Using an Auxiliary Bias Rail

The second specification (see [Figure 29](#)) is referred to as V_{BIAS} Dropout and is for users that wish to tie IN and BIAS together. This option allows the device to be used in applications where an auxiliary bias voltage is not available or low dropout is not required. Dropout is limited by BIAS in these applications because V_{BIAS} provides the gate drive to the pass FET and therefore must be 1.4V above V_{OUT} .

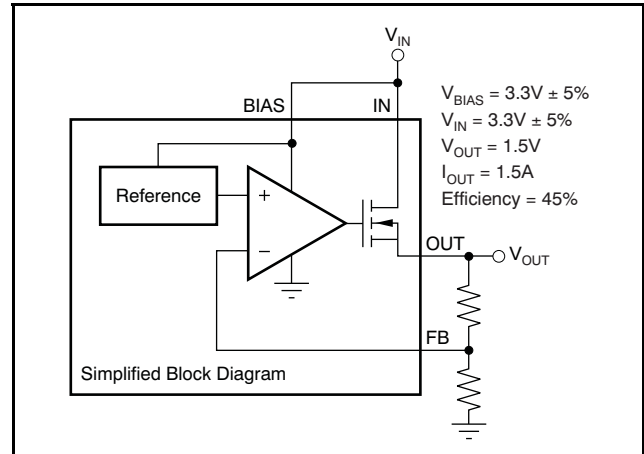

Figure 29. Typical Application of the TPS74401 Without an Auxiliary Bias

PROGRAMMABLE SOFT-START

The TPS74401 features a programmable, monotonic, voltage-controlled soft-start that is set with an external capacitor (C_{SS}). This feature is important for many applications because it eliminates power-up initialization problems when powering FPGAs, DSPs, or other processors. The controlled voltage ramp of the output also reduces peak inrush current during start-up, minimizing start-up transients to the input power bus.

To achieve a linear and monotonic soft-start, the TPS74401 error amplifier tracks the voltage ramp of the external soft-start capacitor until the voltage exceeds the internal reference. The soft-start ramp time depends on the soft-start charging current (I_{SS}), the soft-start capacitance (C_{SS}), and the internal reference voltage (V_{REF}), and can be calculated using [Equation 1](#):

$$t_{SS} = \frac{(V_{REF} \times C_{SS})}{I_{SS}} \quad (1)$$

If large output capacitors are used, the device current limit (I_{CL}) and the output capacitor may set the start-up time. In this case, the start-up time is given by [Equation 2](#):

$$t_{SSCL} = \frac{(V_{OUT(NOM)} \times C_{OUT})}{I_{CL(MIN)}} \quad (2)$$

$V_{OUT(NOM)}$ is the nominal set output voltage as set by the user, C_{OUT} is the output capacitance, and $I_{CL(MIN)}$ is the minimum current limit for the device. In applications where monotonic startup is required, the soft-start time given by [Equation 1](#) should be set to be greater than [Equation 2](#).

The maximum recommended soft-start capacitor is 0.015 μ F. Larger soft-start capacitors can be used and will not damage the device; however, the soft-start capacitor discharge circuit may not be able to fully discharge the soft-start capacitor when re-enabled. Soft-start capacitors larger than 0.015 μ F could be a problem in applications where the user needs to rapidly pulse the enable pin and still requires the device to soft-start from ground. C_{SS} must be low-leakage; X7R, X5R, or C0G dielectric materials are preferred. Refer to [Table 2](#) for suggested soft-start capacitor values.

SEQUENCING REQUIREMENTS

The device can have V_{IN} , V_{BIAS} , and V_{EN} sequenced in any order without causing damage to the device. However, for the soft-start function to work as intended, certain sequencing rules must be applied. Enabling the device after V_{IN} and V_{BIAS} are present is preferred, and can be accomplished using a digital output from a processor or supply supervisor. An analog signal from an external RC circuit, as shown in [Figure 30](#), can also be used as long as the delay time is long enough for V_{IN} and V_{BIAS} to be present.

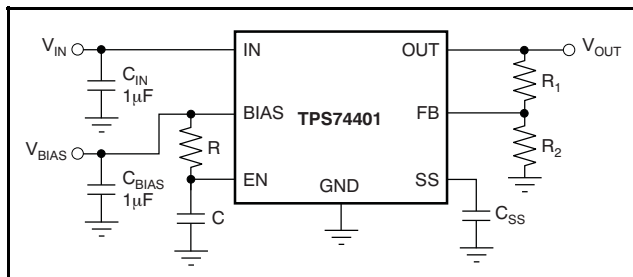

Figure 30. Soft-Start Delay Using an RC Circuit on Enable

If a signal is not available to enable the device after V_{IN} and V_{BIAS} , simply connecting V_{EN} to V_{IN} is acceptable for most applications as long as V_{IN} is greater than 1.1V and the ramp rate of V_{IN} and V_{BIAS} is faster than the set soft-start ramp rate. If the ramp rate of the input sources is slower than the set soft-start time, the output will track the slower supply minus the dropout voltage until it reaches the set output voltage. If V_{EN} is connected to V_{BIAS} , the device will soft-start as programmed provided that V_{IN} is present before V_{BIAS} . If V_{BIAS} and V_{EN} are present before V_{IN} is applied and the set soft-start time has expired then V_{OUT} will track V_{IN} .

OUTPUT NOISE

The TPS74401 provides low output noise when a soft-start capacitor is used. When the device reaches the end of the soft-start cycle, the soft-start capacitor serves as a filter for the internal reference. By using a 0.001 μ F soft-start capacitor, the output noise is

reduced by half and is typically 19 μ V_{RMS} for a 1.2V output (100Hz to 100kHz). Because most of the output noise is generated by the internal reference, the noise is a function of the set output voltage. The RMS noise with a 0.001 μ F soft-start capacitor is given in [Equation 3](#).

$$V_N(\mu\text{V}_{\text{RMS}}) = 16 \left(\frac{\mu\text{V}_{\text{RMS}}}{V} \right) \times V_{\text{OUT}}(V) \quad (3)$$

The low output noise of the TPS74401 makes it a good choice for powering transceivers, PLLs, or other noise-sensitive circuitry.

ENABLE/SHUTDOWN

The enable (EN) pin is active high and is compatible with standard digital signaling levels. V_{EN} below 0.4V turns the regulator off, while V_{EN} above 1.1V turns the regulator on. Unlike many regulators, the enable circuitry has hysteresis and deglitching for use with relatively slow-ramping analog signals. This configuration allows the TPS74401 to be enabled by connecting the output of another supply to the EN pin. The enable circuitry typically has 50mV of hysteresis and a deglitch circuit to help avoid on-off cycling because of small glitches in the V_{EN} signal.

The enable threshold is typically 0.8V and varies with temperature and process variations. Temperature variation is approximately $-1\text{mV}/^\circ\text{C}$; therefore, process variation accounts for most of the variation in the enable threshold. If precise turn-on timing is required, a fast rise-time signal should be used to enable the TPS74401.

If not used, V_{EN} can be connected to either V_{IN} or V_{BIAS} . If V_{EN} is connected to V_{IN} , it should be connected as close as possible to the largest capacitance on the input to prevent voltage droops on that line from triggering the enable circuit.

POWER-GOOD (QFN Package Only)

The power-good (PG) pin is an open-drain output and can be connected to any 5.5V or lower rail through an external pull-up resistor. This pin requires at least 1.1V on V_{BIAS} in order to have a valid output. The PG output is high-impedance when V_{OUT} is greater than $V_{IT} + V_{HYS}$. If V_{OUT} drops below V_{IT} or if V_{BIAS} drops below 1.9V, the open-drain output turns on and pulls the PG output low. The PG pin also asserts when the device is disabled. The pull-up resistor for PG should be in the range of 10k Ω to 1M Ω . PG is only provided on the QFN package. If output voltage monitoring is not needed, the PG pin can be left floating.

INTERNAL CURRENT LIMIT

The TPS74401 features a factory-trimmed, accurate current limit that is flat over temperature and supply voltage. The current limit allows the device to supply surges of up to 3.5A and maintain regulation. The current limit responds in about 10 μ s to reduce the current during a short-circuit fault. Recovery from a short-circuit condition is well-controlled and results in very little output overshoot when the load is removed. See [Figure 26](#) in the [Typical Characteristics](#) section for short-circuit recovery performance.

The internal current limit protection circuitry of the TPS74401 is designed to protect against overload conditions. It is not intended to allow operation above the rated current of the device. Continuously running the TPS74401 above the rated current degrades device reliability.

THERMAL PROTECTION

Thermal protection disables the output when the junction temperature rises to approximately +155°C, allowing the device to cool. When the junction temperature cools to approximately +140°C, the output circuitry is enabled. Depending on power dissipation, thermal resistance, and ambient temperature the thermal protection circuit may cycle on and off. This cycling limits the dissipation of the regulator, protecting it from damage as a result of overheating.

Activation of the thermal protection circuit indicates excessive power dissipation or inadequate heatsinking. For reliable operation, junction temperature should be limited to +125°C maximum. To estimate the margin of safety in a complete design (including heatsink), increase the ambient temperature until thermal protection is triggered; use worst-case loads and signal conditions. For good reliability, thermal protection should trigger at least +30°C above the maximum expected ambient condition of the application. This condition produces a worst-case junction temperature of +125°C at the highest expected ambient temperature and worst-case load.

The internal protection circuitry of the TPS74401 is designed to protect against overload conditions. It is not intended to replace proper heatsinking. Continuously running the TPS74401 into thermal shutdown degrades device reliability.

LAYOUT RECOMMENDATIONS AND POWER DISSIPATION

An optimal layout can greatly improve transient performance, PSRR, and noise. To minimize the voltage droop on the input of the device during load transients, the capacitance on IN and BIAS should be connected as close as possible to the device. This capacitance also minimizes the effects of parasitic inductance and resistance of the input source and can therefore improve stability. To achieve optimal transient performance and accuracy, the top side of R₁ in [Figure 27](#) should be connected as close as possible to the load. If BIAS is connected to IN, it is recommended to connect BIAS as close to the sense point of the input supply as possible. This connection minimizes the voltage droop on BIAS during transient conditions and can improve the turn-on response.

Knowing the device power dissipation and proper sizing of the thermal plane that is connected to the tab or pad is critical to avoiding thermal shutdown and ensuring reliable operation. Power dissipation of the device depends on input voltage and load conditions, and can be calculated using [Equation 4](#):

$$P_D = (V_{IN} - V_{OUT}) \times I_{OUT} \quad (4)$$

Power dissipation can be minimized and greater efficiency can be achieved by using the lowest possible input voltage necessary to achieve the required output voltage regulation.

On both the QFN (RGW) and DPAK (KTW) packages, the primary conduction path for heat is through the exposed pad or tab to the printed circuit board (PCB). The pad or tab can be connected to ground or be left floating; however, it should be attached to an appropriate amount of copper PCB area to ensure the device does not overheat. The maximum junction-to-ambient thermal resistance depends on the maximum ambient temperature, maximum device junction temperature, and power dissipation of the device, and can be calculated using [Equation 5](#):

$$R_{\theta JA} = \frac{(+125^{\circ}\text{C} - T_A)}{P_D} \quad (5)$$

Knowing the maximum R _{θ JA} and system air flow, the minimum amount of PCB copper area needed for appropriate heatsinking can be calculated using [Figure 31](#) through [Figure 35](#).

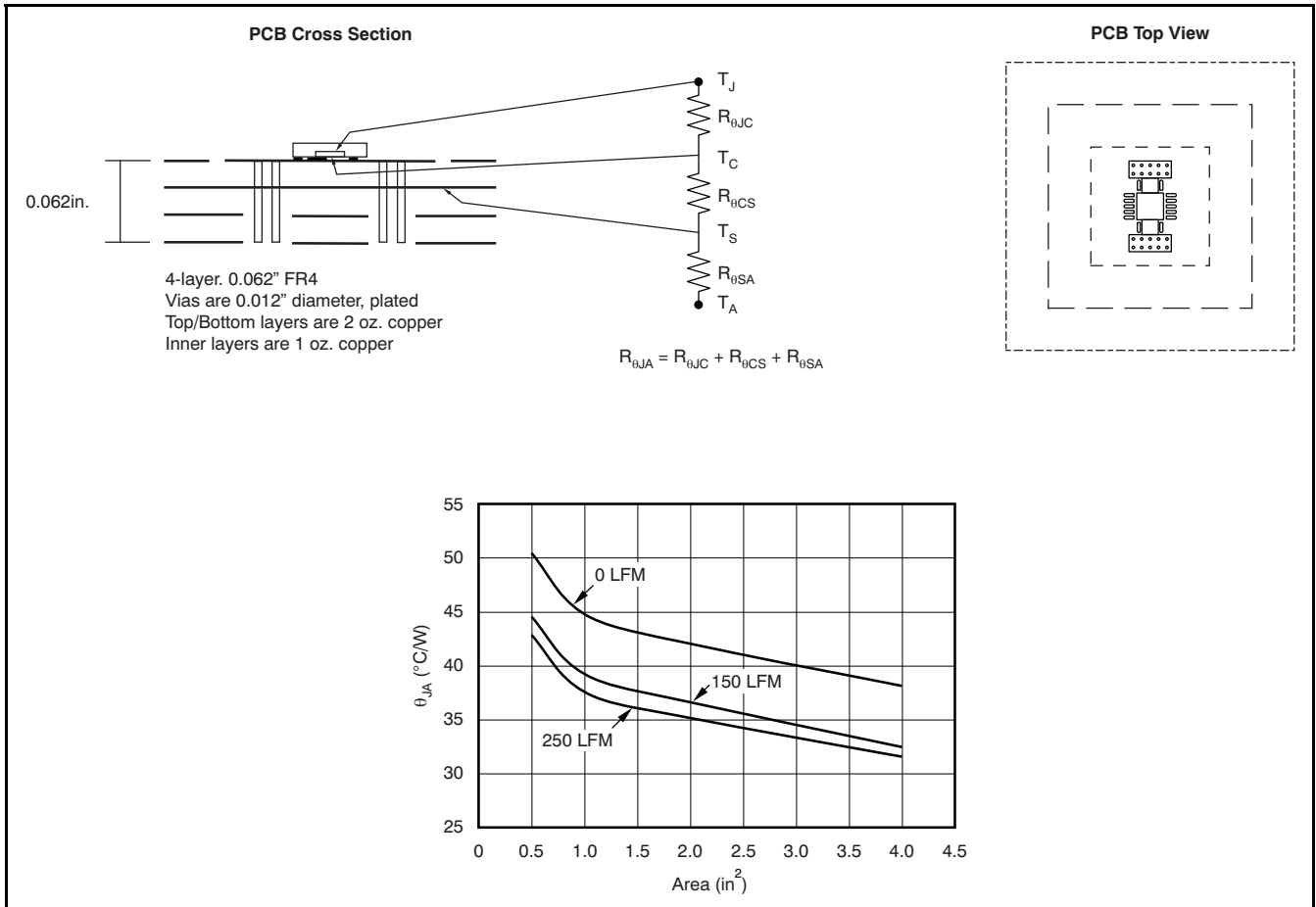

Figure 31. PCB Layout and Corresponding $R_{\theta JA}$ Data, No Vias Under Thermal Pad

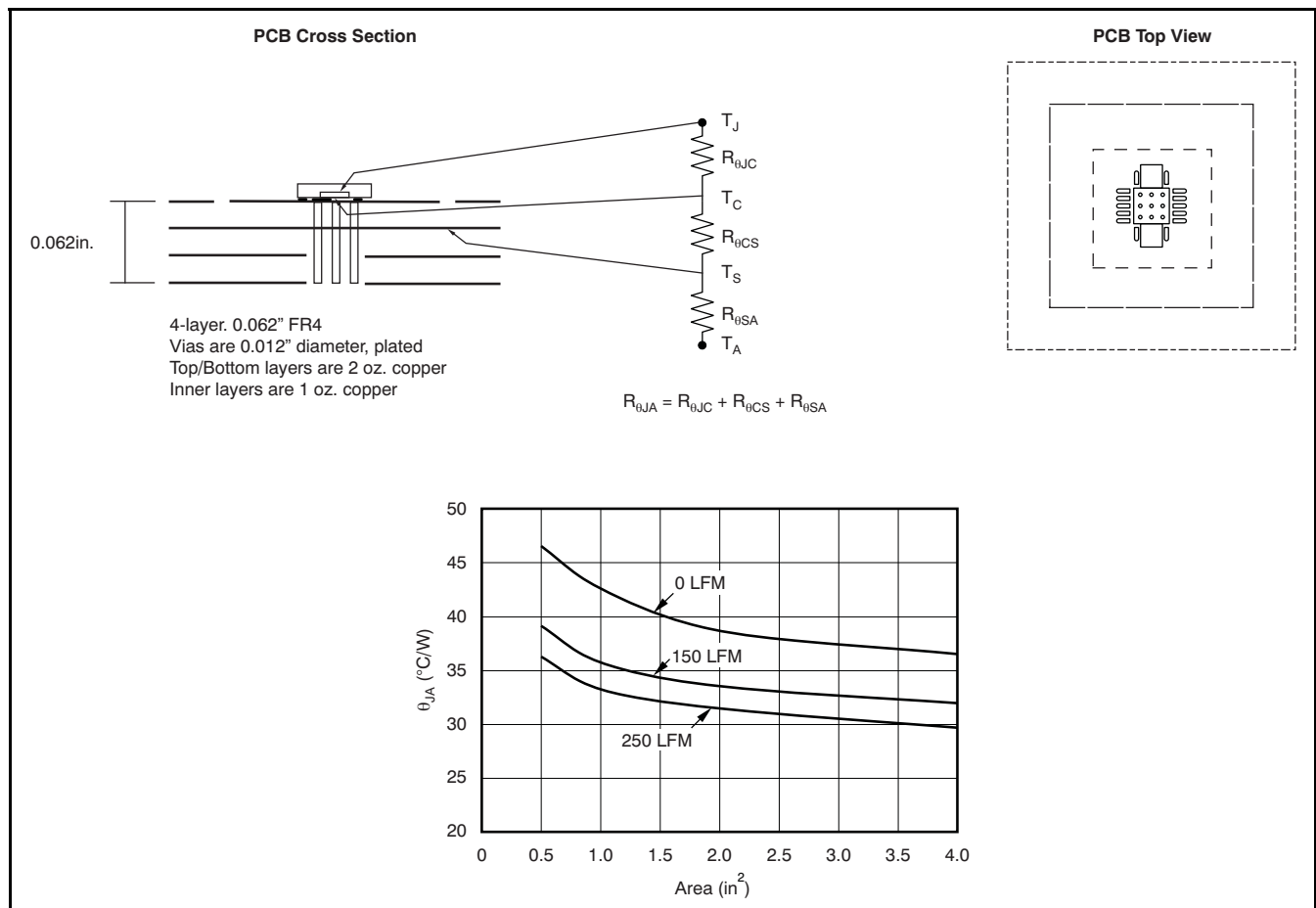

Figure 32. PCB Layout and Corresponding $R_{\theta JA}$ Data, Vias Under Thermal Pad

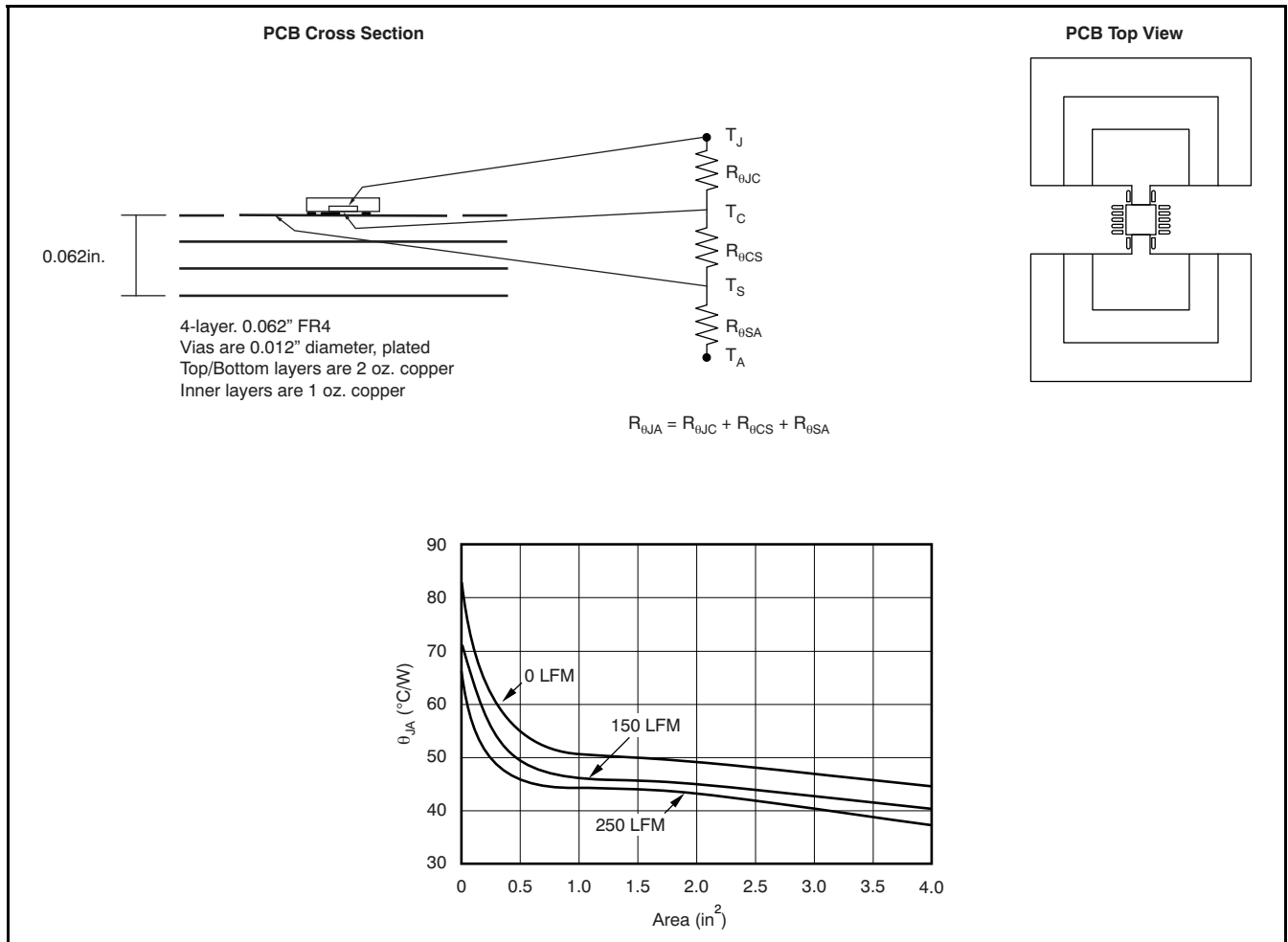

Figure 33. PCB Layout and Corresponding $R_{\theta JA}$ Data, Top Layer Only

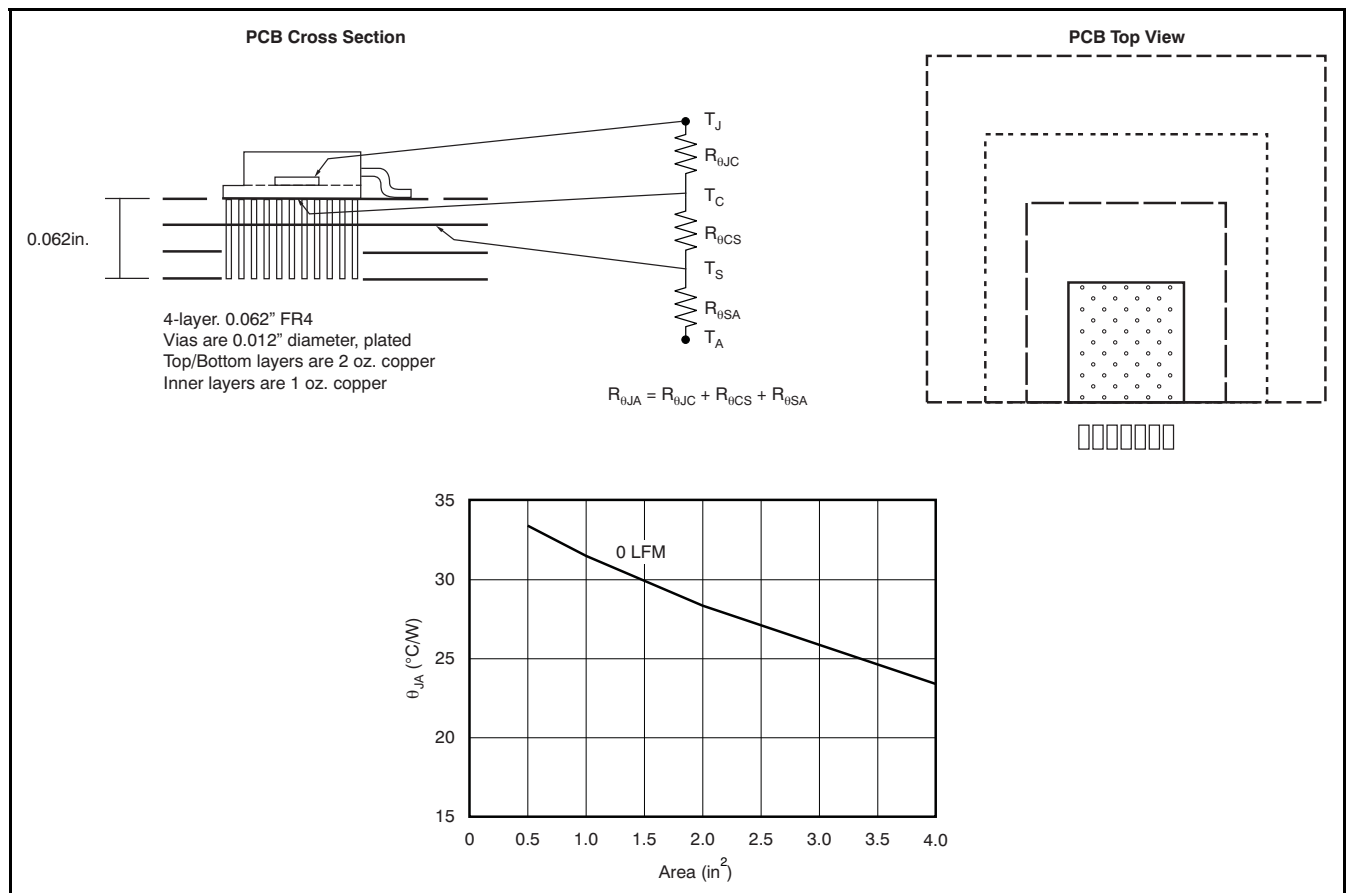

Figure 34. PCB Layout and Corresponding $R_{\theta JA}$, Buried Thermal Plane

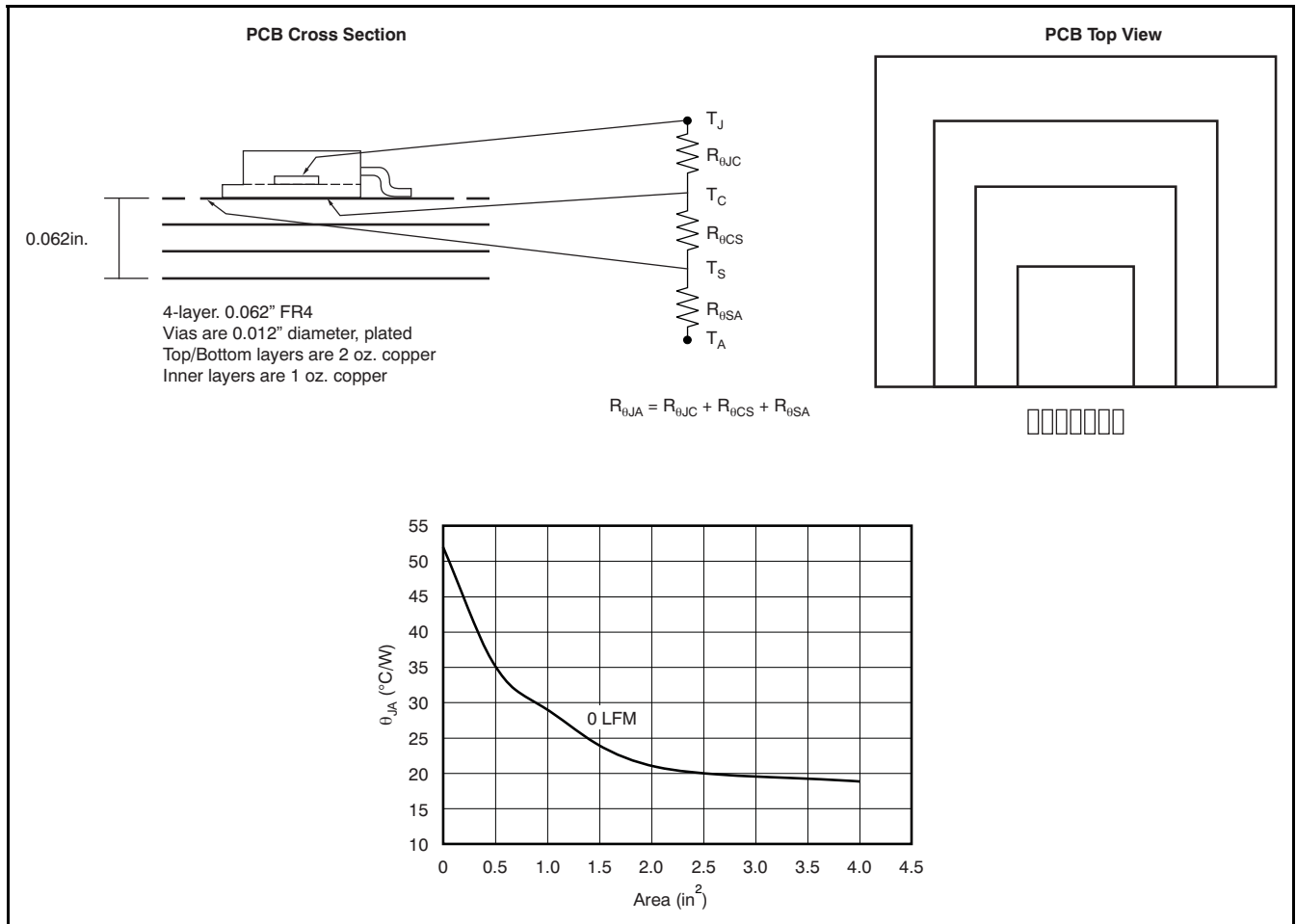

Figure 35. PCB Layout and Corresponding $R_{\theta JA}$, Top Layer Thermal Plane

PACKAGING INFORMATION

Orderable Device	Status ⁽¹⁾	Package Type	Package Drawing	Pins	Package Qty	Eco Plan ⁽²⁾	Lead/Ball Finish	MSL Peak Temp ⁽³⁾
TPS74401KTWR	PREVIEW	DDPAK	KTW	7	500	TBD	Call TI	Call TI
TPS74401KTWT	PREVIEW	DDPAK	KTW	7	50	TBD	Call TI	Call TI
TPS74401RGWR	ACTIVE	QFN	RGW	20	3000	Green (RoHS & no Sb/Br)	CU NIPDAU	Level-2-260C-1 YEAR
TPS74401RGWRG4	ACTIVE	QFN	RGW	20	3000	Green (RoHS & no Sb/Br)	CU NIPDAU	Level-2-260C-1 YEAR
TPS74401RGWT	ACTIVE	QFN	RGW	20	250	Green (RoHS & no Sb/Br)	CU NIPDAU	Level-2-260C-1 YEAR
TPS74401RGWTG4	ACTIVE	QFN	RGW	20	250	Green (RoHS & no Sb/Br)	CU NIPDAU	Level-2-260C-1 YEAR

⁽¹⁾ The marketing status values are defined as follows:

ACTIVE: Product device recommended for new designs.

LIFEBUY: TI has announced that the device will be discontinued, and a lifetime-buy period is in effect.

NRND: Not recommended for new designs. Device is in production to support existing customers, but TI does not recommend using this part in a new design.

PREVIEW: Device has been announced but is not in production. Samples may or may not be available.

OBSELETE: TI has discontinued the production of the device.

⁽²⁾ Eco Plan - The planned eco-friendly classification: Pb-Free (RoHS), Pb-Free (RoHS Exempt), or Green (RoHS & no Sb/Br) - please check <http://www.ti.com/productcontent> for the latest availability information and additional product content details.

TBD: The Pb-Free/Green conversion plan has not been defined.

Pb-Free (RoHS): TI's terms "Lead-Free" or "Pb-Free" mean semiconductor products that are compatible with the current RoHS requirements for all 6 substances, including the requirement that lead not exceed 0.1% by weight in homogeneous materials. Where designed to be soldered at high temperatures, TI Pb-Free products are suitable for use in specified lead-free processes.

Pb-Free (RoHS Exempt): This component has a RoHS exemption for either 1) lead-based flip-chip solder bumps used between the die and package, or 2) lead-based die adhesive used between the die and leadframe. The component is otherwise considered Pb-Free (RoHS compatible) as defined above.

Green (RoHS & no Sb/Br): TI defines "Green" to mean Pb-Free (RoHS compatible), and free of Bromine (Br) and Antimony (Sb) based flame retardants (Br or Sb do not exceed 0.1% by weight in homogeneous material)

⁽³⁾ MSL, Peak Temp. -- The Moisture Sensitivity Level rating according to the JEDEC industry standard classifications, and peak solder temperature.

Important Information and Disclaimer:The information provided on this page represents TI's knowledge and belief as of the date that it is provided. TI bases its knowledge and belief on information provided by third parties, and makes no representation or warranty as to the accuracy of such information. Efforts are underway to better integrate information from third parties. TI has taken and continues to take reasonable steps to provide representative and accurate information but may not have conducted destructive testing or chemical analysis on incoming materials and chemicals. TI and TI suppliers consider certain information to be proprietary, and thus CAS numbers and other limited information may not be available for release.

In no event shall TI's liability arising out of such information exceed the total purchase price of the TI part(s) at issue in this document sold by TI to Customer on an annual basis.

KTW (R-PSFM-G7)

PLASTIC FLANGE-MOUNT

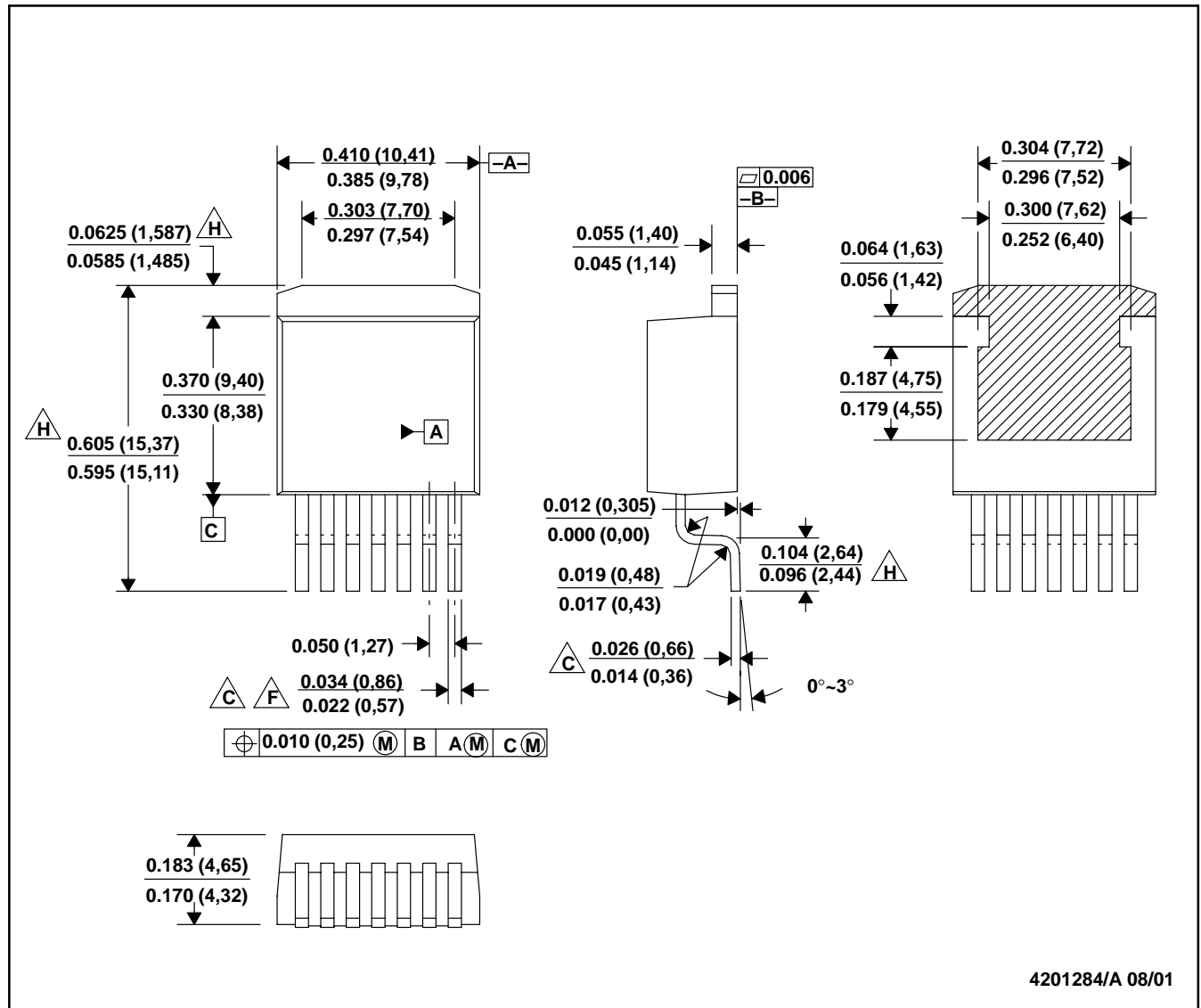

- NOTES: A. All linear dimensions are in inches (millimeters).
 B. This drawing is subject to change without notice.
 $\triangle C$. Lead width and height dimensions apply to the plated lead.
 D. Leads are not allowed above the Datum B.
 E. Stand-off height is measured from lead tip with reference to Datum B.
 $\triangle F$. Lead width dimension does not include dambar protrusion. Allowable dambar protrusion shall not cause the lead width to exceed the maximum dimension by more than 0.003".
 G. Cross-hatch indicates exposed metal surface.
 $\triangle H$. Falls within JEDEC MO-169 with the exception of the dimensions indicated.

IMPORTANT NOTICE

Texas Instruments Incorporated and its subsidiaries (TI) reserve the right to make corrections, modifications, enhancements, improvements, and other changes to its products and services at any time and to discontinue any product or service without notice. Customers should obtain the latest relevant information before placing orders and should verify that such information is current and complete. All products are sold subject to TI's terms and conditions of sale supplied at the time of order acknowledgment.

TI warrants performance of its hardware products to the specifications applicable at the time of sale in accordance with TI's standard warranty. Testing and other quality control techniques are used to the extent TI deems necessary to support this warranty. Except where mandated by government requirements, testing of all parameters of each product is not necessarily performed.

TI assumes no liability for applications assistance or customer product design. Customers are responsible for their products and applications using TI components. To minimize the risks associated with customer products and applications, customers should provide adequate design and operating safeguards.

TI does not warrant or represent that any license, either express or implied, is granted under any TI patent right, copyright, mask work right, or other TI intellectual property right relating to any combination, machine, or process in which TI products or services are used. Information published by TI regarding third-party products or services does not constitute a license from TI to use such products or services or a warranty or endorsement thereof. Use of such information may require a license from a third party under the patents or other intellectual property of the third party, or a license from TI under the patents or other intellectual property of TI.

Reproduction of information in TI data books or data sheets is permissible only if reproduction is without alteration and is accompanied by all associated warranties, conditions, limitations, and notices. Reproduction of this information with alteration is an unfair and deceptive business practice. TI is not responsible or liable for such altered documentation.

Resale of TI products or services with statements different from or beyond the parameters stated by TI for that product or service voids all express and any implied warranties for the associated TI product or service and is an unfair and deceptive business practice. TI is not responsible or liable for any such statements.

Following are URLs where you can obtain information on other Texas Instruments products and application solutions:

Products		Applications	
Amplifiers	amplifier.ti.com	Audio	www.ti.com/audio
Data Converters	dataconverter.ti.com	Automotive	www.ti.com/automotive
DSP	dsp.ti.com	Broadband	www.ti.com/broadband
Interface	interface.ti.com	Digital Control	www.ti.com/digitalcontrol
Logic	logic.ti.com	Military	www.ti.com/military
Power Mgmt	power.ti.com	Optical Networking	www.ti.com/opticalnetwork
Microcontrollers	microcontroller.ti.com	Security	www.ti.com/security
Low Power Wireless	www.ti.com/lpw	Telephony	www.ti.com/telephony
		Video & Imaging	www.ti.com/video
		Wireless	www.ti.com/wireless

Mailing Address: Texas Instruments
Post Office Box 655303 Dallas, Texas 75265