



N-Channel 20-V (D-S) 175° MOSFET

CHARACTERISTICS

- N-Channel Vertical DMOS
- Macro Model (Subcircuit Model)
- Level 3 MOS
- Apply for both Linear and Switching Application
- Accurate over the -55 to 125°C Temperature Range
- Model the Gate Charge, Transient, and Diode Reverse Recovery Characteristics

DESCRIPTION

The attached spice model describes the typical electrical characteristics of the n-channel vertical DMOS. The subcircuit model is extracted and optimized over the -55 to 125°C temperature ranges under the pulsed 0 to 10V gate drive. The saturated output impedance is best fit at the gate bias near the threshold voltage.

A novel gate-to-drain feedback capacitance network is used to model the gate charge characteristics while avoiding convergence difficulties of the switched C_{gd} model. All model parameter values are optimized to provide a best fit to the measured electrical data and are not intended as an exact physical interpretation of the device.

SUBCIRCUIT MODEL SCHEMATIC

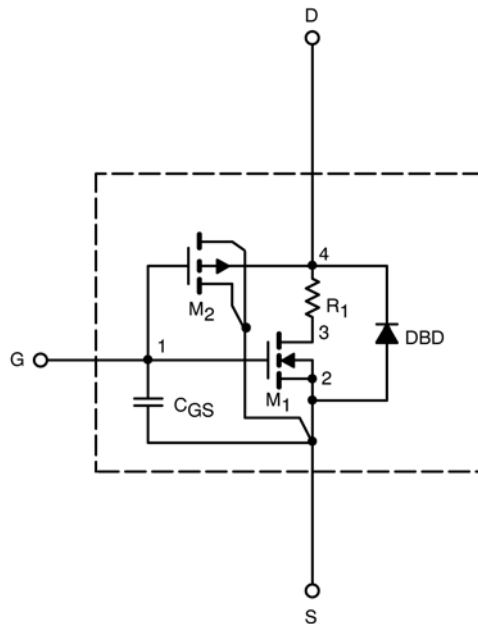

This document is intended as a SPICE modeling guideline and does not constitute a commercial product data sheet. Designers should refer to the appropriate data sheet of the same number for guaranteed specification limits.

SPICE Device Model SUD50N02-06P

Vishay Siliconix



SPECIFICATIONS (T _J = 25°C UNLESS OTHERWISE NOTED)					
Parameter	Symbol	Test Conditions	Simulated Data	Measured Data	Unit
Static					
Gate Threshold Voltage	V _{GS(th)}	V _{DS} = V _{GS} , I _D = 250 μA	1.4		V
On-State Drain Current ^b	I _{D(on)}	V _{DS} = 5 V, V _{GS} = 10 V	964		A
Drain-Source On-State Resistance ^b	r _{DS(on)}	V _{GS} = 10 V, I _D = 20 A	0.0041	0.0046	Ω
		V _{GS} = 10 V, I _D = 20 A, T _J = 125°C	0.0057		
		V _{GS} = 4.5 V, I _D = 20 A	0.0065	0.0073	
Forward Voltage ^b	V _{SD}	I _S = 50 A, V _{GS} = 0 V	0.91	1.2	V
Dynamic^a					
Input Capacitance	C _{iss}	V _{GS} = 0 V, V _{DS} = 25 V, f = 1 MHz	2418	2550	pF
Output Capacitance	C _{oss}		816	900	
Reverse Transfer Capacitance	C _{rss}		348	415	
Total Gate Charge ^c	Q _g	V _{DS} = 10 V, V _{GS} = 4.5 V, I _D = 50 A	20	19	nC
Gate-Source Charge ^c	Q _{gs}		7.5	7.5	
Gate-Drain Charge ^c	Q _{gd}		6	6	
Turn-On Delay Time ^c	t _{d(on)}	V _{DD} = 10 V, R _L = 0.20 Ω I _D ≅ 50 A, V _{GEN} = 10 V, R _G = 2.5 Ω	11	11	ns
Rise Time ^c	t _r		10	10	
Turn-Off Delay Time ^c	t _{d(off)}		9	24	
Fall Time ^c	t _f		9	9	
Source-Drain Reverse Recovery Time	t _{rr}	I _F = 50 A, di/dt = 100 A/μs	31	35	

Notes

- a. Guaranteed by design, not subject to production testing.
- b. Pulse test; pulse width ≤ 300 μs, duty cycle ≤ 2%.
- c. Independent of operating temperature.



SPICE Device Model SUD50N02-06P

Vishay Siliconix

COMPARISON OF MODEL WITH MEASURED DATA ($T_J=25^\circ\text{C}$ UNLESS OTHERWISE NOTED)

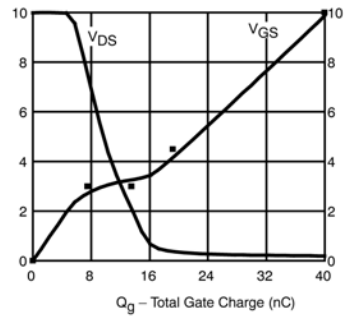
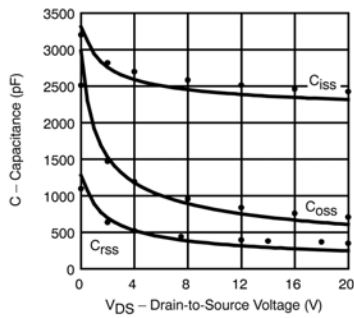
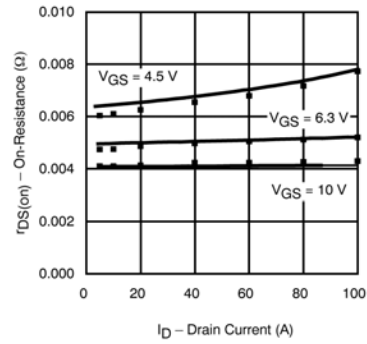
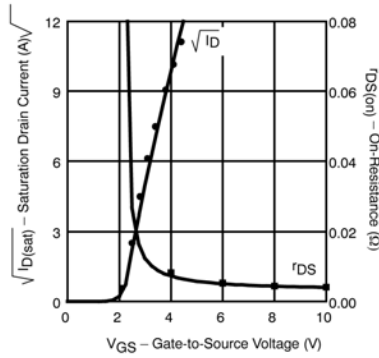
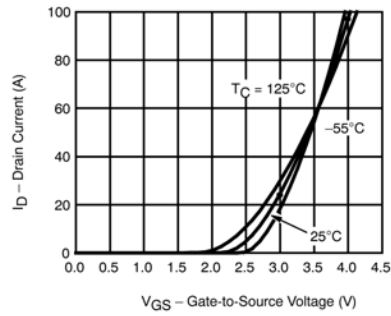
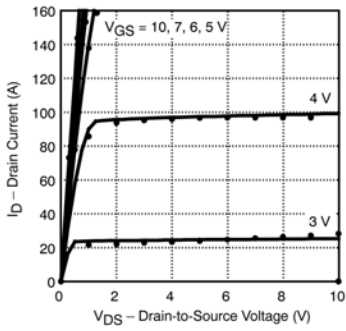

Note: Dots and squares represent measured data.