

General Purpose Transistors PNP Silicon

 Lead(Pb)-Free

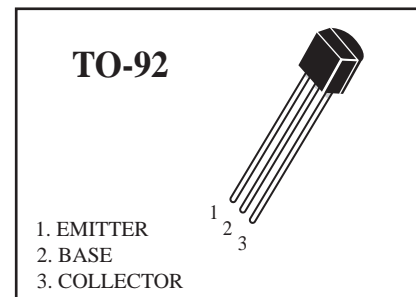
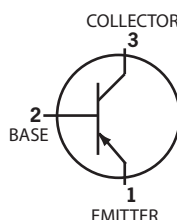

ABSOLUTE MAXIMUM RATINGS (Ta=25°C)

Rating	Symbol	2N4403	Unit
Collector-Emitter Voltage	V _{CEO}	-40	Vdc
Collector-Base Voltage	V _{CBO}	-40	Vdc
Emitter-Base Voltage	V _{EBO}	-5.0	Vdc
Collector Current	I _C	-600	mAdc
Total Device Dissipation T _A =25°C	P _D	-625	mW
Junction Temperature	T _j	150	°C
Storage Temperature	T _{stg}	-55 to +150	°C

DEVICE MARKING

2N4403=2N4403

ELECTRICAL CHARACTERISTICS

Characteristics	Symbol	Min	Max	Unit
Collector-Emitter Breakdown Voltage ⁽¹⁾ (I _C = -1.0 mAdc, I _B =0)	V _{(BR)CEO}	-40	-	Vdc
Collector-Base Breakdown Voltage (I _C = -0.1 mAdc, I _E =0)	V _{(BR)CBO}	-40	-	Vdc
Emitter-Base Breakdown Voltage (I _E = -0.1 mAdc, I _C =0)	V _{(BR)EBO}	-5.0	-	Vdc
Base Cutoff Current (V _{CB} = -35 Vdc, I _E =0)	I _{CBO}	-	-0.1	uAdc
Collect Cutoff Current (V _{CE} = -35 Vdc, I _B =0)	I _{CEO}	-	-0.1	uAdc

1. Pulse Test: Pulse Width ≤ 300 us, Duty Cycle ≤ 2.0%

2N4403

 **WEITRON**

ELECTRICAL CHARACTERISTICS ($T_A=25^\circ\text{C}$ unless otherwise noted) (Continued)

Characteristics	Symbol	Min	Max	Unit
-----------------	--------	-----	-----	------

ON CHARACTERISTICS

DC Current Gain ($I_C = -0.1 \text{ mAdc}, V_{CE} = -1.0 \text{ Vdc}$) ($I_C = -1.0 \text{ mAdc}, V_{CE} = -1.0 \text{ Vdc}$) ($I_C = -10 \text{ mAdc}, V_{CE} = -1.0 \text{ Vdc}$) ($I_C = -150 \text{ mAdc}, V_{CE} = -2.0 \text{ Vdc}$) ⁽¹⁾ ($I_C = -500 \text{ mAdc}, V_{CE} = -2.0 \text{ Vdc}$) ⁽¹⁾	h_{FE}	30 60 100 100 20	- - - 300 -	-
Collector-Emitter Saturation Voltage (1) ($I_C = -150 \text{ mAdc}, I_B = -15 \text{ mAdc}$) ($I_C = -500 \text{ mAdc}, I_B = -50 \text{ mAdc}$)	$V_{CE(sat)}$	- -	-0.4 -0.75	Vdc
Base-Emitter Saturation Voltage (1) ($I_C = -150 \text{ mAdc}, I_B = -15 \text{ mAdc}$) ($I_C = -500 \text{ mAdc}, I_B = -50 \text{ mAdc}$)	$V_{BE(sat)}$	-0.75 -	-0.95 -1.3	Vdc

SMALL-SIGNAL CHARACTERISTICS

Current-Gain-Bandwidth Product ($I_C = -20 \text{ mAdc}, V_{CE} = -10 \text{ Vdc}, f = 100 \text{ MHz}$)	f_T	200	-	MHz
Collector-Base Capacitance ($I_E = 0, V_{CB} = -10 \text{ Vdc}, f = 1.0 \text{ MHz}$)	C_{cb}	-	8.5	pF
Emitter-Base Capacitance ($I_C = 0, V_{EB} = -0.5 \text{ Vdc}, f = 1.0 \text{ MHz}$)	C_{eb}	-	30	pF
Input Impedance ($I_C = -1.0 \text{ mAdc}, V_{CE} = -10 \text{ Vdc}, f = 1.0 \text{ kHz}$)	h_{ie}	1.5k	15k	ohms
Voltage Feedback Ratio ($I_C = -1.0 \text{ mAdc}, V_{CE} = -10 \text{ Vdc}, f = 1.0 \text{ kHz}$)	h_{re}	0.1	8.0	$\times 10^{-4}$
Small-Signal Current Gain ($I_C = -1.0 \text{ mAdc}, V_{CE} = -10 \text{ Vdc}, f = 1.0 \text{ kHz}$)	h_{fe}	60	500	-
Output Admittance ($I_C = -1.0 \text{ mAdc}, V_{CE} = -10 \text{ Vdc}, f = 1.0 \text{ kHz}$)	h_{oe}	1.0	100	umhos

SWITCHING CHARACTERISTICS

Delay Time	$(V_{CC} = -30 \text{ Vdc}, V_{BE} = +2.0 \text{ Adc}, I_C = -150 \text{ mAdc}, I_{B1} = -15 \text{ mAdc})$	t_d	-	15	ns
Rise Time		t_r	-	20	
Storage Time	$(V_{CC} = -30 \text{ Vdc}, I_C = -150 \text{ mAdc}, I_{B1} = -15 \text{ mAdc}, I_{B2} = -15 \text{ mAdc})$	t_s	-	225	
Fall Time		t_f	-	30	

1. Pulse Test : Pulse Width $\leq 300\mu\text{s}$, Duty Cycle $\leq 2\%$

WEITRON

<http://www.weitron.com.tw>

SWITCHING TIME EQUIVALENT TEST CIRCUIT

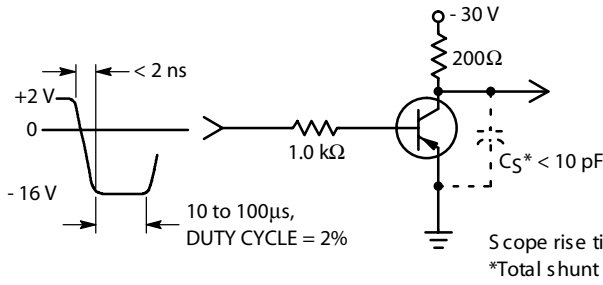

FIG 1. Turn-On Time

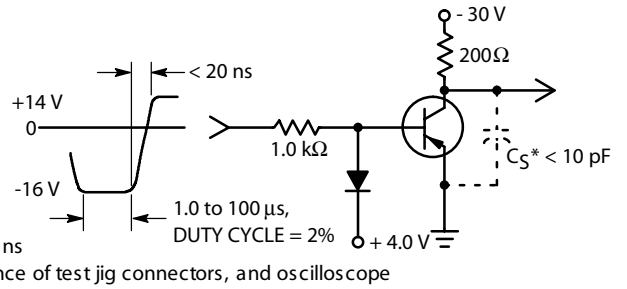

FIG 2. Turn-Off Time

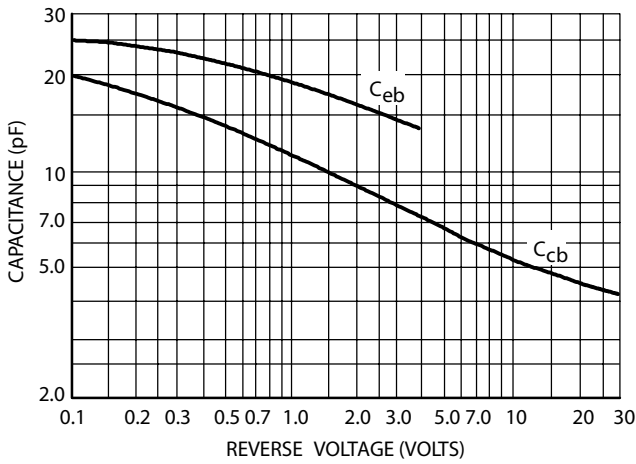

FIG 3. Capacitances

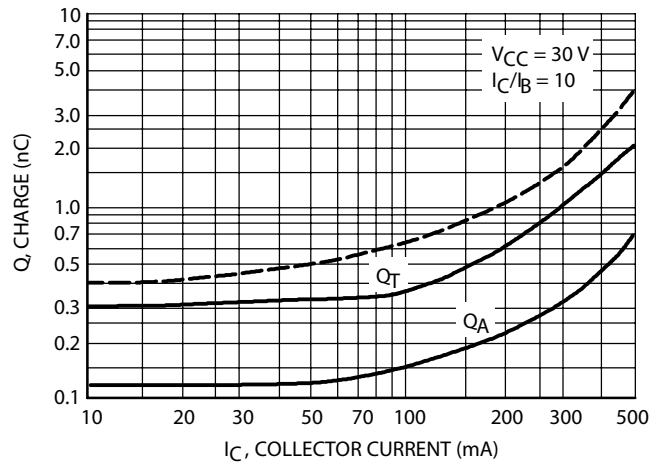

FIG 4. Charge Data

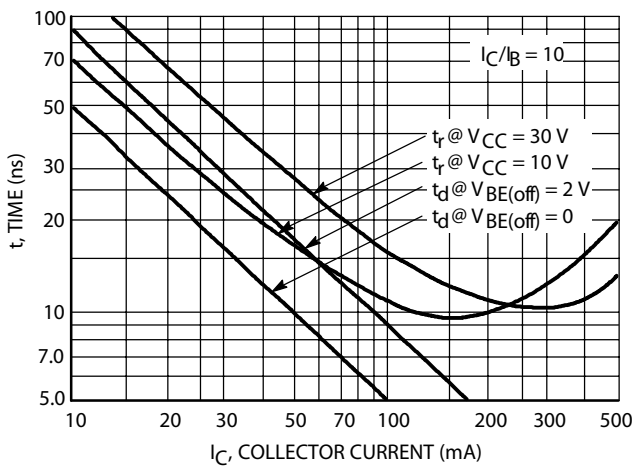

FIG5. Turn-On Time

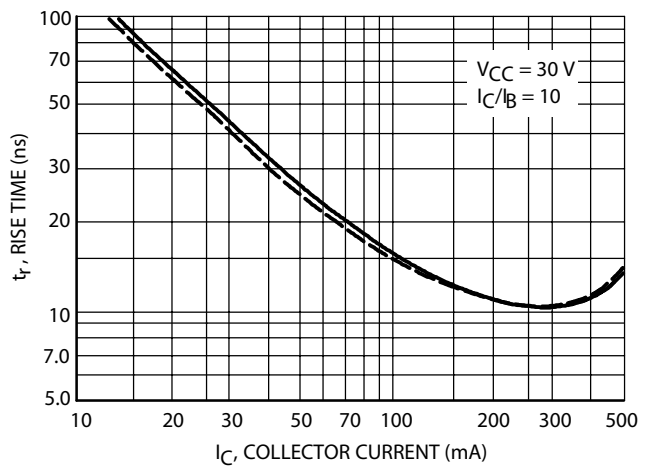

FIG 6. Rise Time

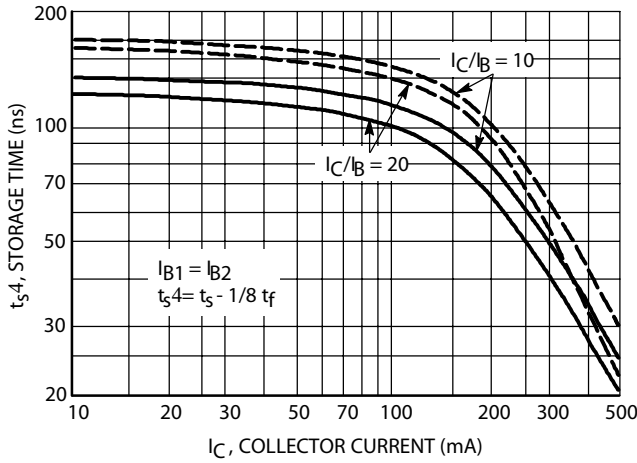

FIG. 7 Storage Time

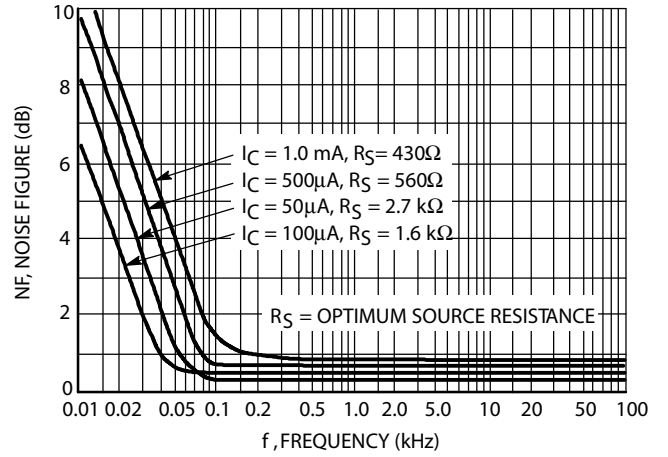

FIG. 8 Frequency Effects

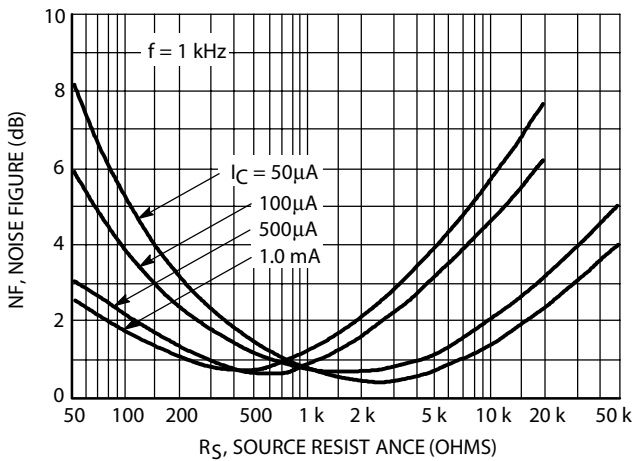

FIG. 9 Source Resistance Effects

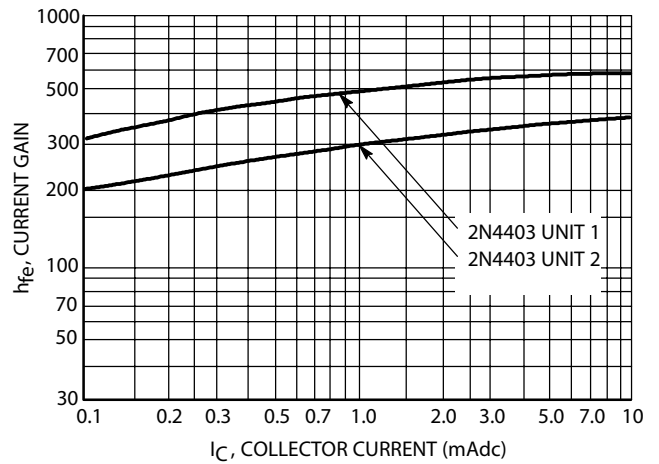

FIG. 10 Current Gain

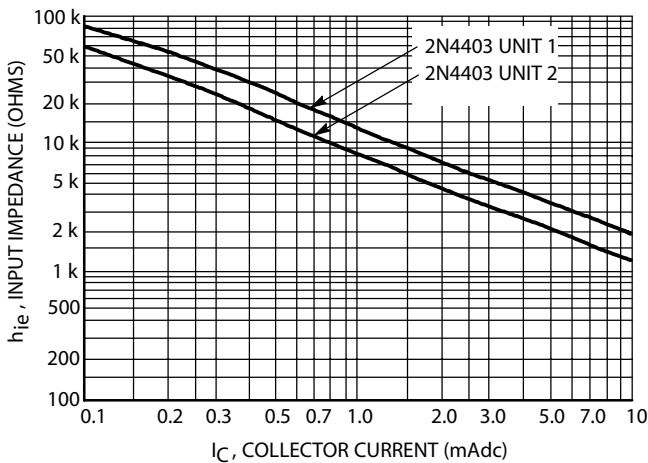

FIG. 11 Input Impedance

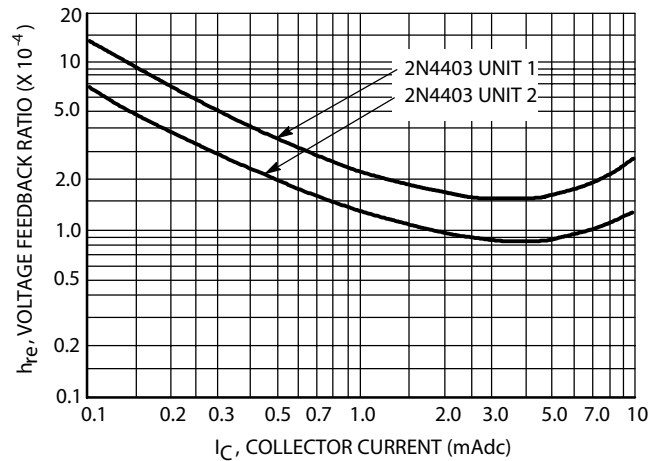

FIG. 12 Voltage Feedback Ratio

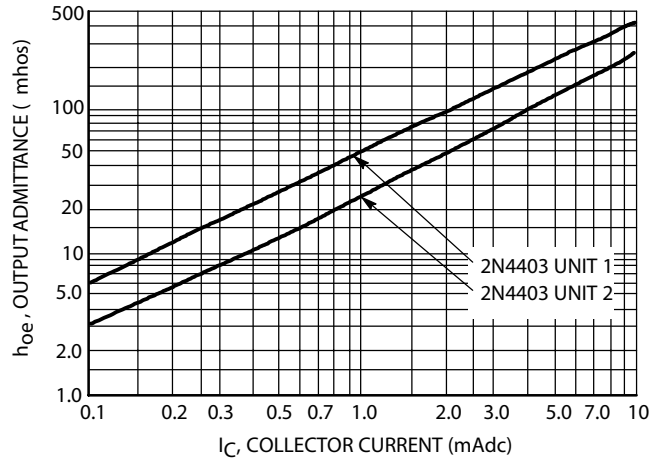

FIG. 13 Output Admittance

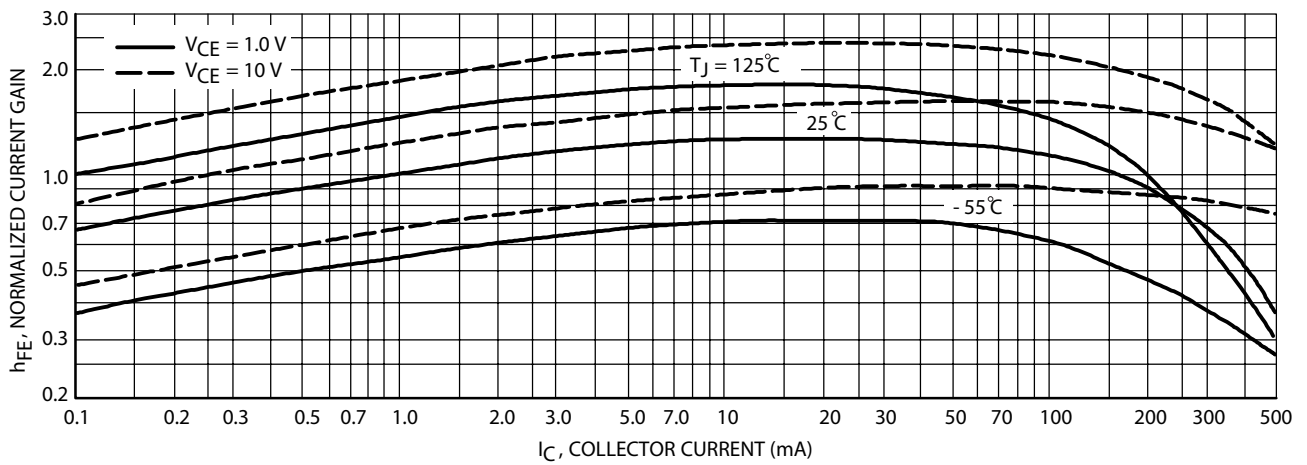

FIG. 14 DC Current Gain

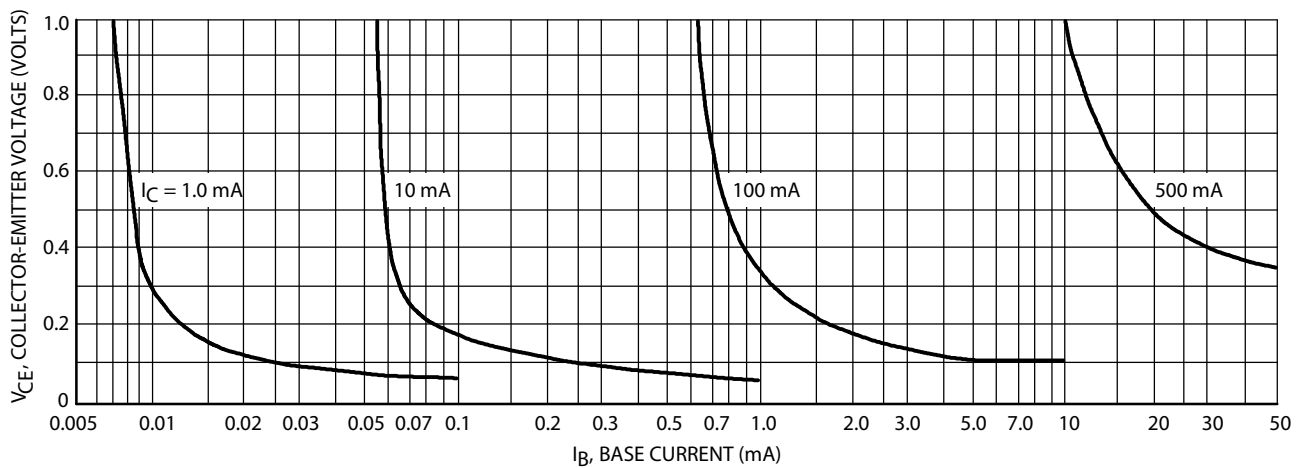

FIG. 15 Collector Saturation Region

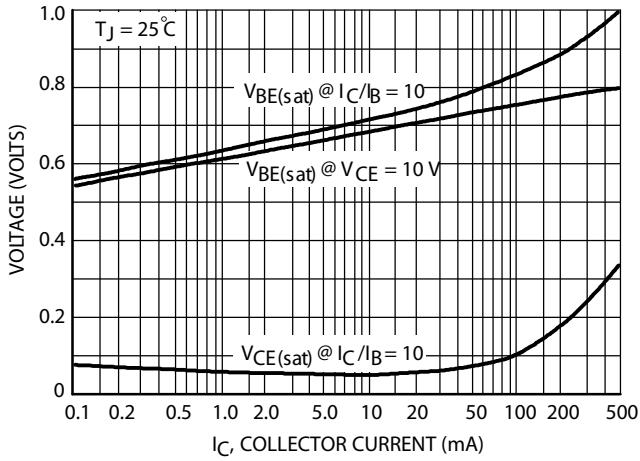

FIG. 16 "On" Voltages

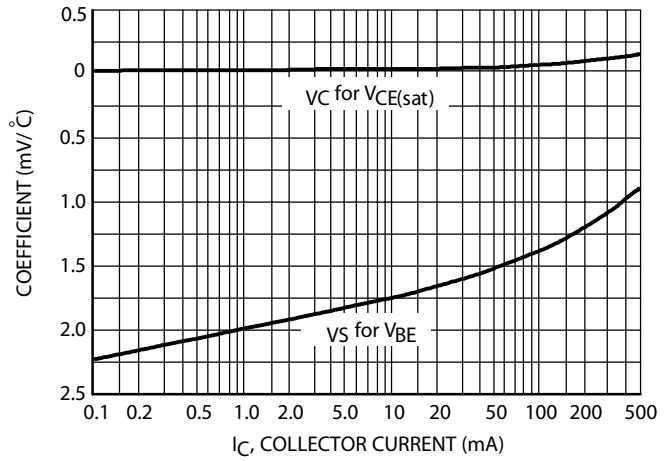
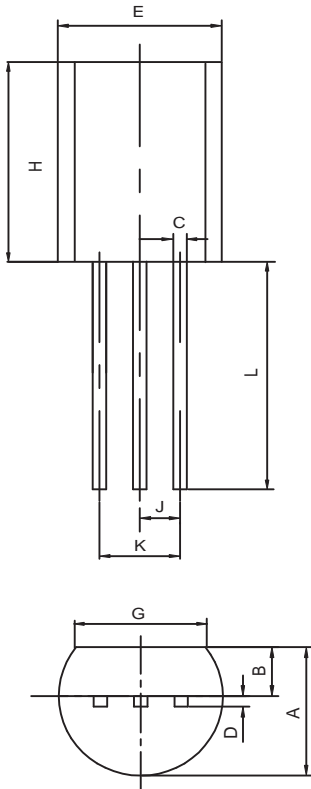

FIG. 17 Temperature Coefficients

TO-92 Outline Dimensions

unit:mm



TO-92		
Dim	Min	Max
A	3.30	3.70
B	1.10	1.40
C	0.38	0.55
D	0.36	0.51
E	4.40	4.70
G	3.43	-
H	4.30	4.70
J	1.270TYP	
K	2.44	2.64
L	14.10	14.50