



STPS20150CT/CG/CR/CFP

HIGH VOLTAGE POWER SCHOTTKY RECTIFIER

MAIN PRODUCT CHARACTERISTICS

$I_{F(AV)}$	2 x 10 A
V_{RRM}	150 V
T_j	175°C
$V_F(max)$	0.75 V

FEATURES AND BENEFITS

- HIGH JUNCTION TEMPERATURE CAPABILITY
- GOOD TRADE OFF BETWEEN LEAKAGE CURRENT AND FORWARD VOLTAGE DROP
- LOW LEAKAGE CURRENT
- AVALANCHE CAPABILITY SPECIFIED

DESCRIPTION

Dual center tap schottky rectifier designed for high frequency Switched Mode Power Supplies.

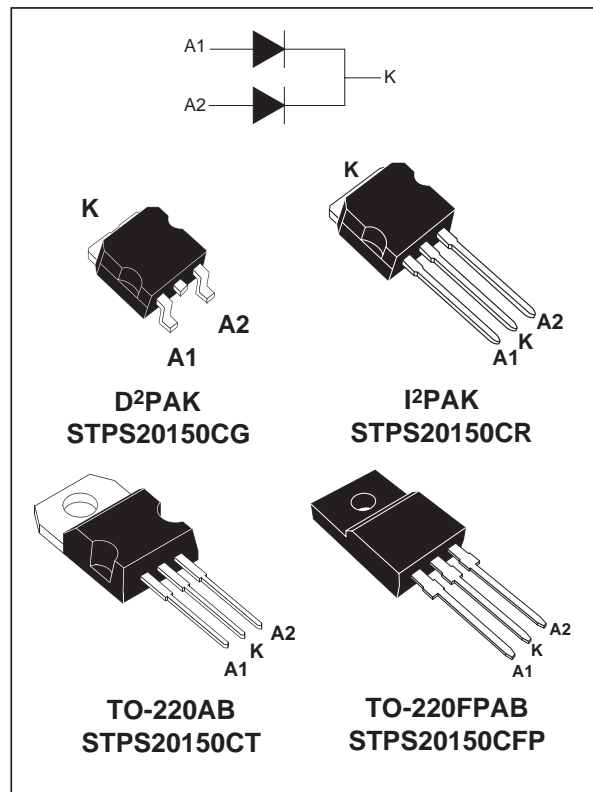

ABSOLUTE RATINGS (limiting values, per diode)

Symbol	Parameter			Value	Unit	
V_{RRM}	Repetitive peak reverse voltage			150	V	
$I_{F(RMS)}$	RMS forward current			30	A	
$I_{F(AV)}$	Average forward current $\delta = 0.5$	TO-220AB D ² PAK / I ² PAK	$T_c = 155^\circ\text{C}$	Per diode	10	A
		TO-220FPAB	$T_c = 135^\circ\text{C}$	Per device	20	
I_{FSM}	Surge non repetitive forward current		$t_p = 10\text{ ms}$ sinusoidal	180	A	
P_{ARM}	Repetitive peak avalanche power		$t_p = 1\mu\text{s}$ $T_j = 25^\circ\text{C}$	6700	W	
T_{stg}	Storage temperature range			- 65 to + 175	°C	
T_j	Maximum operating junction temperature			175	°C	
dV/dt	Critical rate of rise of reverse voltage			10000	V/ μs	

THERMAL RESISTANCES

Symbol	Parameter			Value	Unit
R _{th(j-c)}	Junction to case	TO-220AB / D ² PAK / I ² PAK	Per diode	2.2	°C/W
		TO-220FPAB		4.5	
		TO-220AB / D ² PAK / I ² PAK	Total	1.3	
		TO-220FPAB		3.5	
R _{th(c)}		TO-220AB / D ² PAK / I ² PAK	Coupling	0.3	
		TO-220FPAB		2.5	

When the diodes 1 and 2 are used simultaneously :
 $\Delta T_j(\text{diode 1}) = P(\text{diode1}) \times R_{th(j-c)}(\text{Per diode}) + P(\text{diode 2}) \times R_{th(c)}$

STATIC ELECTRICAL CHARACTERISTICS (per diode)

Symbol	Parameter	Tests conditions		Min.	Typ.	Max.	Unit
I _R *	Reverse leakage current	T _j = 25°C	V _R = V _{RRM}			5.0	μA
		T _j = 125°C				5.0	mA
V _F **	Forward voltage drop	T _j = 25°C	I _F = 10 A			0.92	V
		T _j = 125°C	I _F = 10 A		0.69	0.75	
		T _j = 25°C	I _F = 20 A			1	
		T _j = 125°C	I _F = 20 A		0.79	0.86	

Pulse test : * tp = 5 ms, δ < 2%
 ** tp = 380 μs, δ < 2%

To evaluate the conduction losses use the following equation:
 $P = 0.64 \times I_{F(AV)} + 0.011 I_{F(RMS)}^2$

Fig. 1: Average forward power dissipation versus average forward current (per diode).

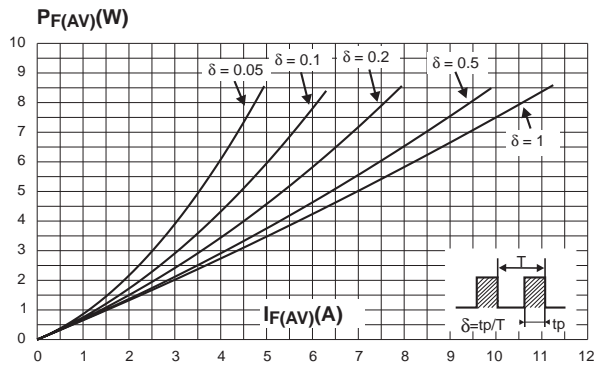

Fig. 2: Average forward current versus ambient temperature ($\delta = 0.5$, per diode).

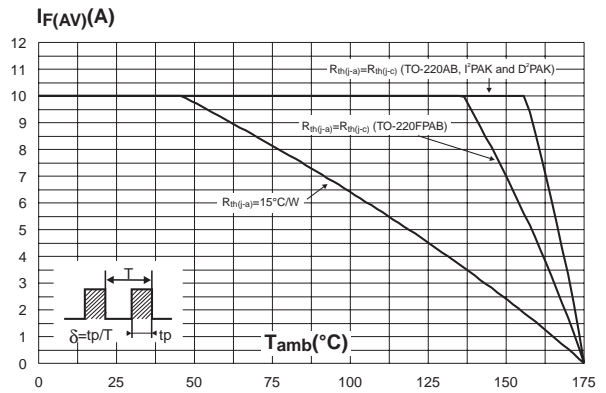

Fig. 3: Normalized avalanche power derating versus pulse duration.

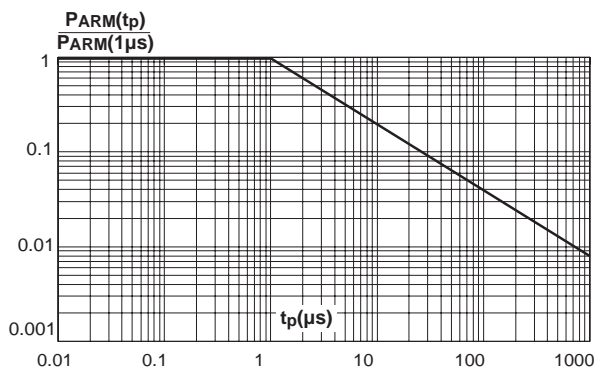

Fig. 4: Normalized avalanche power derating versus junction temperature.

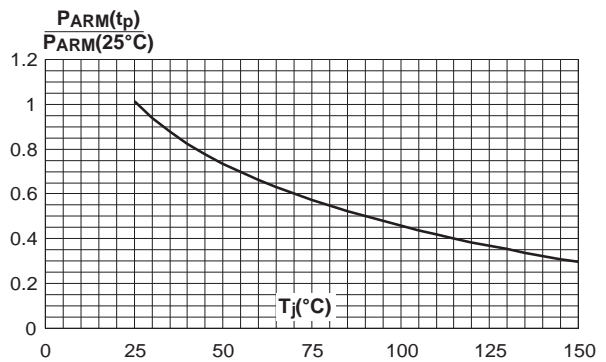

Fig. 5-1: Non repetitive surge peak forward current versus overload duration (maximum values, per diode). TO-220AB, I²PAK and D²PAK

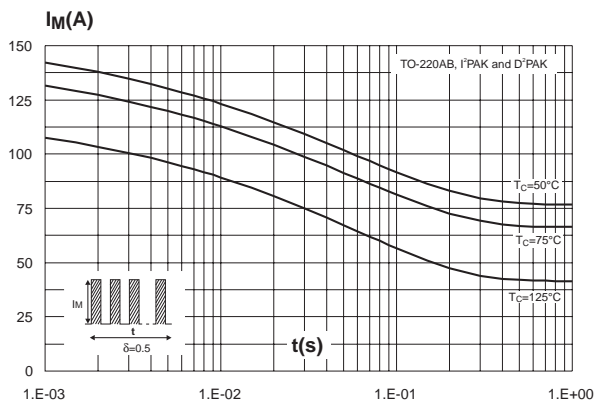

Fig. 5-2: Non repetitive surge peak forward current versus overload duration (maximum values, per diode). TO-220FPAB

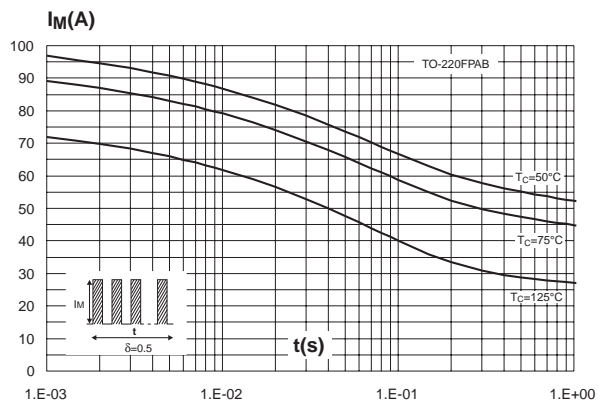

Fig. 6-1: Relative variation of thermal impedance junction to case versus pulse duration. TO-220AB, I²PAK and D²PAK

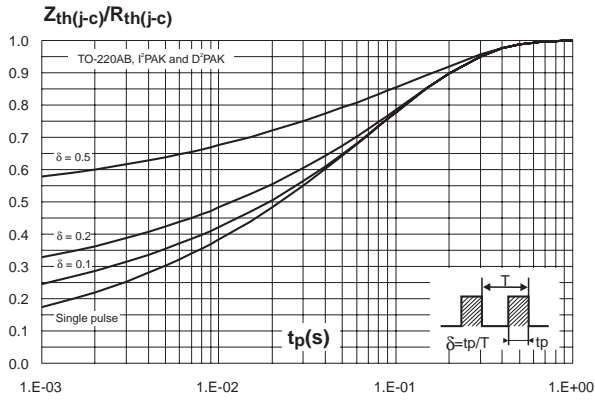

Fig. 6-2: Relative variation of thermal impedance junction to case versus pulse duration. TO-220FPAB

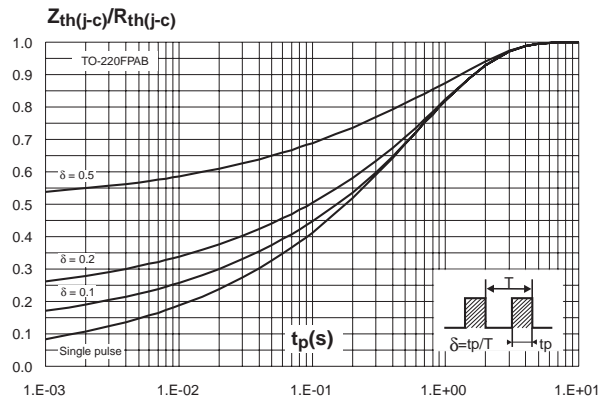

Fig. 7: Reverse leakage current versus reverse voltage applied (typical values, per diode).

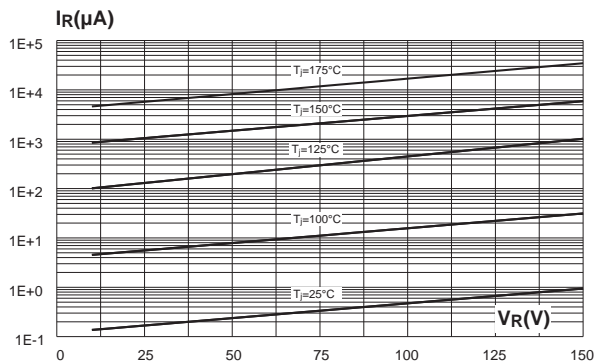

Fig. 8: Junction capacitance versus reverse voltage applied (typical values, per diode).

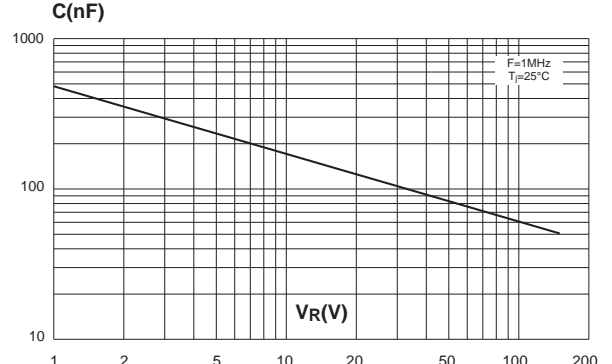

Fig. 8: Forward voltage drop versus forward current (per diode).

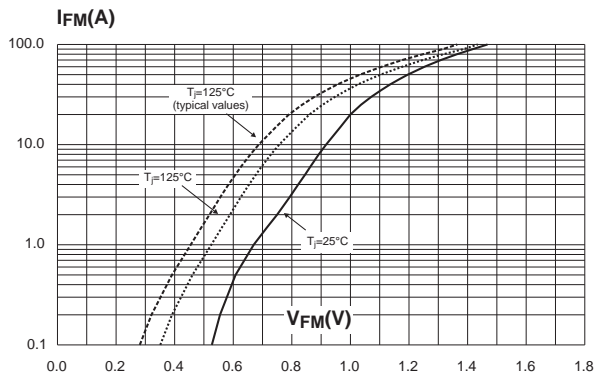
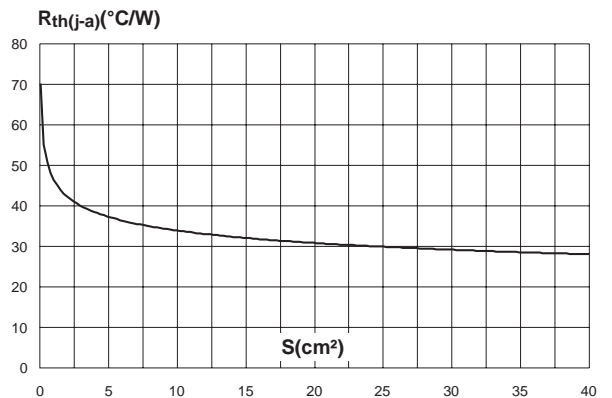
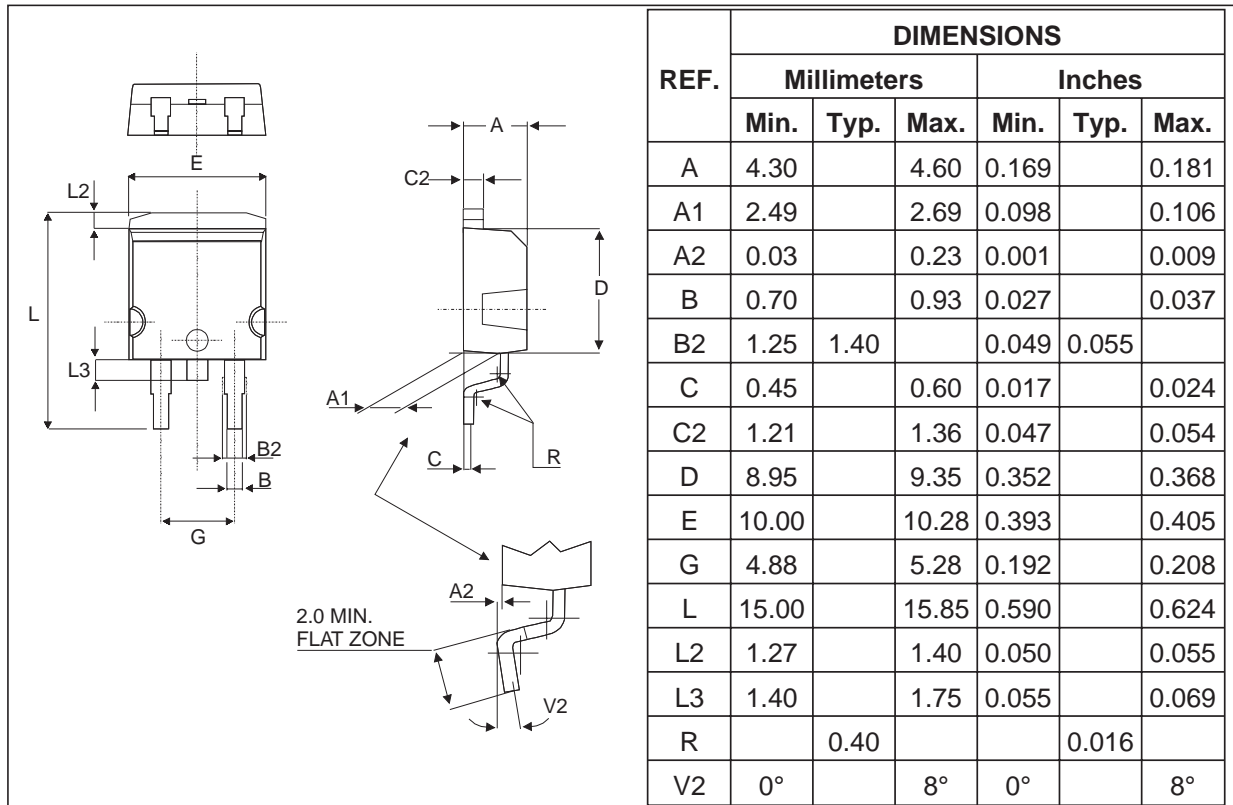

Fig. 9: Thermal resistance junction to ambient versus copper surface under tab (Epoxy printed circuit board, $Cu = 35\mu m$) (STPS20150CG only).



PACKAGE MECHANICAL DATA
D²PAK



FOOT PRINT DIMENSIONS (in millimeters)

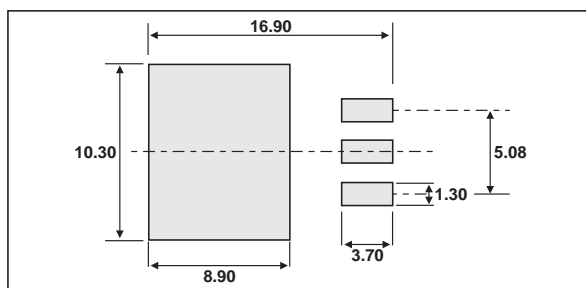

STPS20150CT/CG/CR/CFP

PACKAGE MECHANICAL DATA
TO-220AB

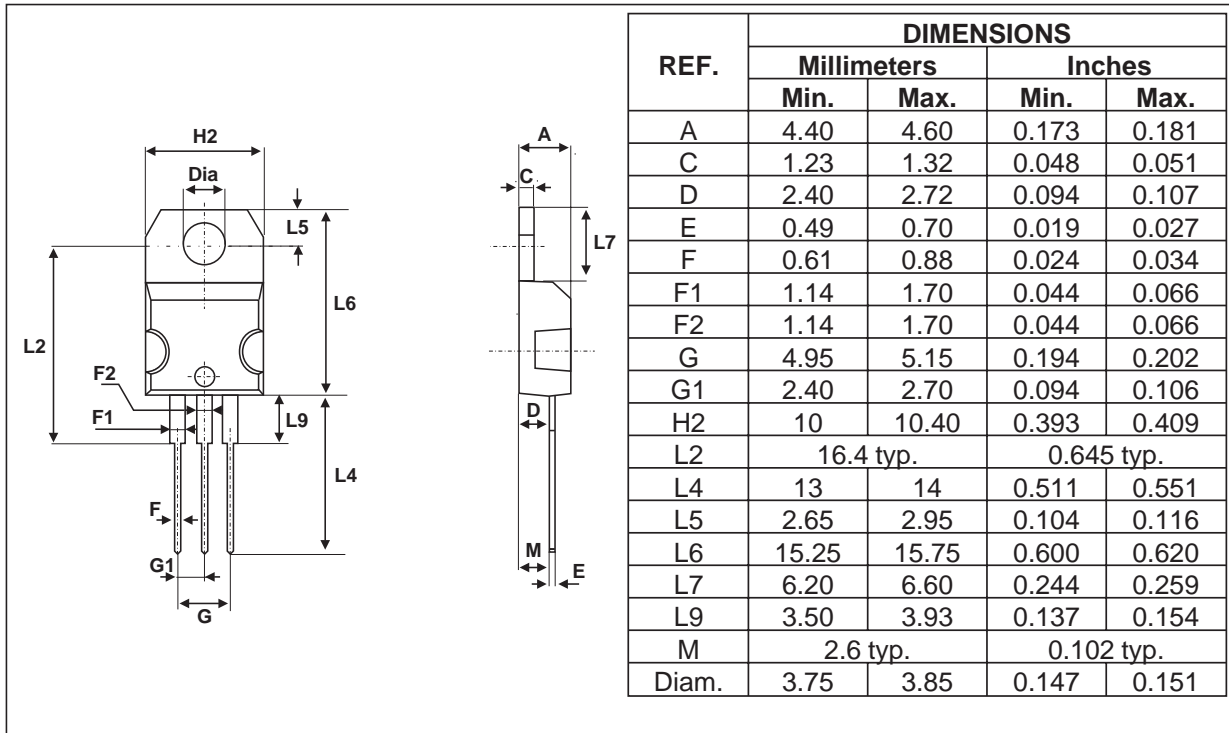

PACKAGE MECHANICAL DATA
I²PAK

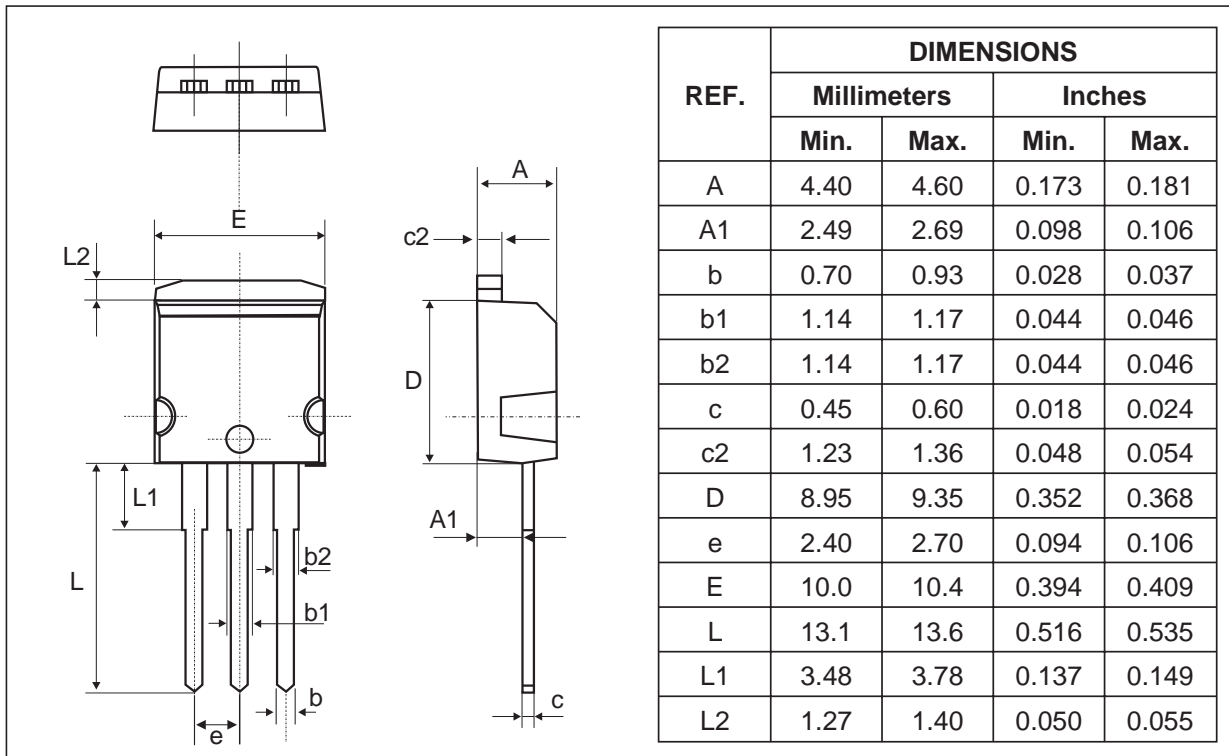

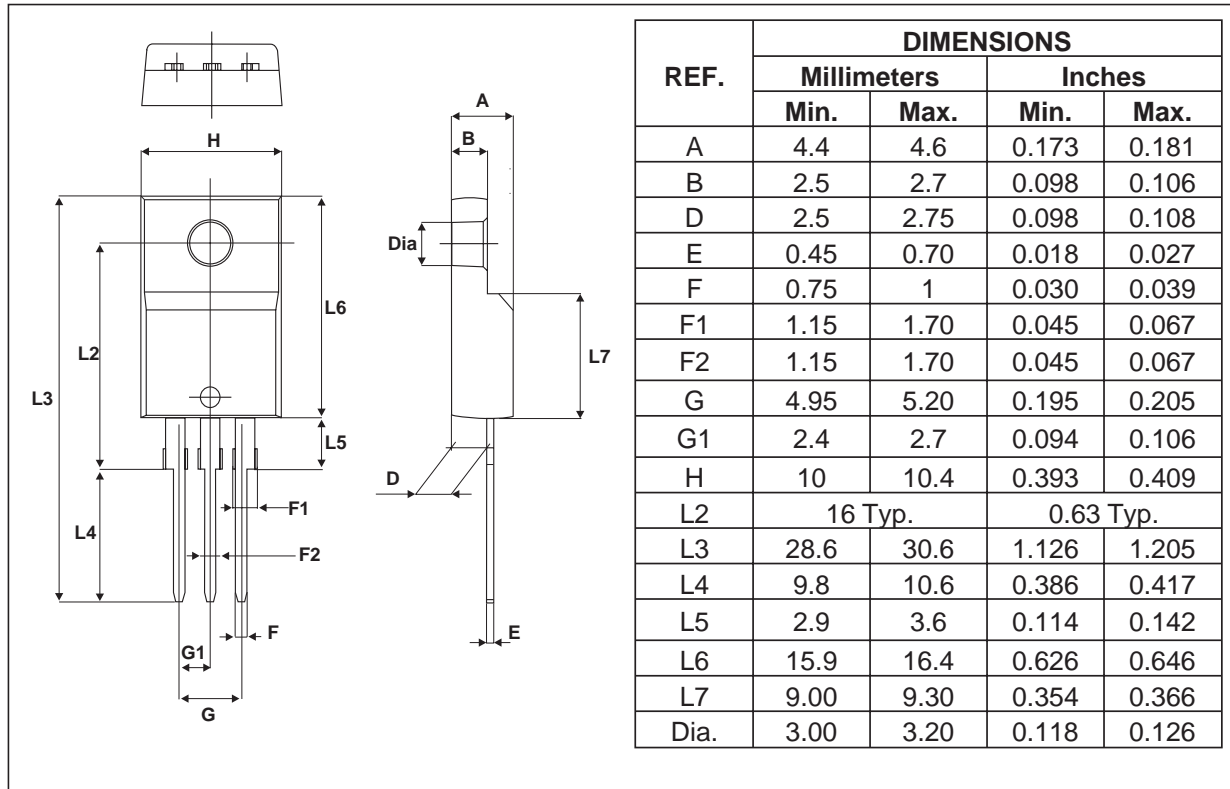
PACKAGE MECHANICAL DATA
 TO-220FPAB

OTHER INFORMATION

Ordering type	Marking	Package	Weight	Base qty	Delivery mode
STPS20150CT	STPS20150CT	TO-220AB	2.20 g	50	Tube
STPS20150CG	STPS20150CG	D ² PAK	1.48 g	50	Tube
STPS20150CG-TR	STPS20150CG	D ² PAK	1.48 g	1000	Tape & Reel
STPS20150CR	STPS20150CR	I ² PAK	1.49 g	50	Tube
STPS20150CFP	STPS20150CFP	TO-220FPAB	2.0 g	50	Tube

■ EPOXY MEETS UL94,V0

Information furnished is believed to be accurate and reliable. However, STMicroelectronics assumes no responsibility for the consequences of use of such information nor for any infringement of patents or other rights of third parties which may result from its use. No license is granted by implication or otherwise under any patent or patent rights of STMicroelectronics. Specifications mentioned in this publication are subject to change without notice. This publication supersedes and replaces all information previously supplied. STMicroelectronics products are not authorized for use as critical components in life support devices or systems without express written approval of STMicroelectronics.

The ST logo is a registered trademark of STMicroelectronics

© 2003 STMicroelectronics - Printed in Italy - All rights reserved.

STMicroelectronics GROUP OF COMPANIES

Australia - Brazil - Canada - China - Finland - France - Germany
 Hong Kong - India - Israel - Italy - Japan - Malaysia - Malta - Morocco - Singapore
 Spain - Sweden - Switzerland - United Kingdom - United States.



<http://www.st.com>