

# DTA114EET1 Series

Preferred Devices

## Bias Resistor Transistors

### PNP Silicon Surface Mount Transistors with Monolithic Bias Resistor Network

This new series of digital transistors is designed to replace a single device and its external resistor bias network. The Bias Resistor Transistor (BRT) contains a single transistor with a monolithic bias network consisting of two resistors; a series base resistor and a base-emitter resistor. The BRT eliminates these individual components by integrating them into a single device. The use of a BRT can reduce both system cost and board space. The device is housed in the SC-75/SOT-416 package which is designed for low power surface mount applications.

#### Features

- Pb-Free Packages are Available\*
- Simplifies Circuit Design
- Reduces Board Space
- Reduces Component Count
- The SC-75/SOT-416 package can be soldered using wave or reflow. The modified gull-winged leads absorb thermal stress during soldering eliminating the possibility of damage to the die.
- Available in 8 mm, 7 inch/3000 Unit Tape & Reel

#### MAXIMUM RATINGS ( $T_A = 25^\circ\text{C}$ unless otherwise noted)

Rating	Symbol	Value	Unit
Collector-Base Voltage	$V_{CBO}$	50	Vdc
Collector-Emitter Voltage	$V_{CEO}$	50	Vdc
Collector Current	$I_C$	100	mAdc

Maximum ratings are those values beyond which device damage can occur. Maximum ratings applied to the device are individual stress limit values (not normal operating conditions) and are not valid simultaneously. If these limits are exceeded, device functional operation is not implied, damage may occur and reliability may be affected.

#### THERMAL CHARACTERISTICS

Rating	Symbol	Value	Unit
Total Device Dissipation, FR-4 Board (Note 1) @ $T_A = 25^\circ\text{C}$ Derate above $25^\circ\text{C}$	$P_D$	200 1.6	mW mW/ $^\circ\text{C}$
Thermal Resistance, Junction-to-Ambient (Note 1)	$R_{\theta JA}$	600	$^\circ\text{C}/\text{W}$
Total Device Dissipation, FR-4 Board (Note 2) @ $T_A = 25^\circ\text{C}$ Derate above $25^\circ\text{C}$	$P_D$	300 2.4	mW mW/ $^\circ\text{C}$
Thermal Resistance, Junction-to-Ambient (Note 2)	$R_{\theta JA}$	400	$^\circ\text{C}/\text{W}$
Junction and Storage Temperature Range	$T_J, T_{stg}$	-55 to +150	$^\circ\text{C}$

1. FR-4 @ Minimum Pad.
2. FR-4 @  $1.0 \times 1.0$  Inch Pad.



ON Semiconductor®

<http://onsemi.com>

## PNP SILICON BIAS RESISTOR TRANSISTORS

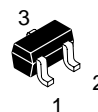
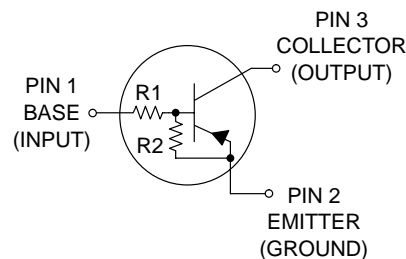

#### MARKING DIAGRAM

SC-75/SOT-416  
CASE 463  
STYLE 1

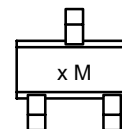

x = Specific Device Code  
M = Date Code

#### ORDERING INFORMATION

See detailed ordering and shipping information in the package dimensions section on page 2 of this data sheet.

\*For additional information on our Pb-Free strategy and soldering details, please download the ON Semiconductor Soldering and Mounting Techniques Reference Manual, SOLDERRM/D.

Preferred devices are recommended choices for future use and best overall value.

## DTA114EET1 Series

### ORDERING INFORMATION AND RESISTOR VALUES

Device	Marking	R1 (K)	R2 (K)	Package	Shipping†
DTA114EET1	6A	10	10	SC-75	3000 Tape & Reel
DTA124EET1	6B	22	22	SC-75	3000 Tape & Reel
DTA144EET1	6C	47	47	SC-75	3000 Tape & Reel
DTA114YET1	6D	10	47	SC-75	3000 Tape & Reel
DTA114TET1	6E	10	∞	SC-75	3000 Tape & Reel
DTA143TET1	6F	4.7	∞	SC-75	3000 Tape & Reel
DTA123EET1	6H	2.2	2.2	SC-75	3000 Tape & Reel
DTA123EET1G	6H	2.2	2.2	SC-75 (Pb-Free)	3000 Tape & Reel
DTA143EE	6J	4.7	4.7	SC-75	3000 Tape & Reel
DTA143EET1	6J	4.7	4.7	SC-75	3000 Tape & Reel
DTA143EET1G	6J	4.7	4.7	SC-75 (Pb-Free)	3000 Tape & Reel
DTA143ZET1	6K	4.7	47	SC-75	3000 Tape & Reel
DTA124XET1	6L	22	47	SC-75	3000 Tape & Reel
DTA124XET1G	6L	22	47	SC-75 (Pb-Free)	3000 Tape & Reel
DTA123JET1	6M	2.2	47	SC-75	3000 Tape & Reel
DTA115EET1	6N	100	100	SC-75	3000 Tape & Reel
DTA144WET1	6P	47	22	SC-75	3000 Tape & Reel

†For information on tape and reel specifications, including part orientation and tape sizes, please refer to our Tape and Reel Packaging Specifications Brochure, BRD8011/D.

### ELECTRICAL CHARACTERISTICS ( $T_A = 25^\circ\text{C}$ unless otherwise noted)

Characteristic	Symbol	Min	Typ	Max	Unit
<b>OFF CHARACTERISTICS</b>					
Collector-Base Cutoff Current ( $V_{CB} = 50\text{ V}$ , $I_E = 0$ )	$I_{CBO}$	–	–	100	nAdc
Collector-Emitter Cutoff Current ( $V_{CE} = 50\text{ V}$ , $I_B = 0$ )	$I_{CEO}$	–	–	500	nAdc
Emitter-Base Cutoff Current ( $V_{EB} = 6.0\text{ V}$ , $I_C = 0$ )	$I_{EBO}$	–	–	0.5	mAdc
DTA114EET1		–	–	0.2	
DTA124EET1		–	–	0.1	
DTA144EET1		–	–	0.2	
DTA114YET1		–	–	0.9	
DTA114TET1		–	–	1.9	
DTA143TET1		–	–	2.3	
DTA123EET1		–	–	1.5	
DTA143EET1		–	–	0.18	
DTA143ZET1		–	–	0.13	
DTA124XET1		–	–	0.2	
DTA123JET1		–	–	0.05	
DTA115EET1		–	–	0.13	
DTA144WET1		–	–		
Collector-Base Breakdown Voltage ( $I_C = 10\ \mu\text{A}$ , $I_E = 0$ )	$V_{(BR)CBO}$	50	–	–	Vdc
Collector-Emitter Breakdown Voltage (Note 3) ( $I_C = 2.0\text{ mA}$ , $I_B = 0$ )	$V_{(BR)CEO}$	50	–	–	Vdc

3. Pulse Test: Pulse Width < 300  $\mu\text{s}$ , Duty Cycle < 2.0%

## DTA114EET1 Series

### ELECTRICAL CHARACTERISTICS ( $T_A = 25^\circ\text{C}$ unless otherwise noted) (Continued)

Characteristic	Symbol	Min	Typ	Max	Unit	
<b>ON CHARACTERISTICS</b> (Note 4)						
DC Current Gain ( $V_{CE} = 10\text{ V}$ , $I_C = 5.0\text{ mA}$ )	DTA114EET1 DTA124EET1 DTA144EET1 DTA114YET1 DTA114TET1 DTA143TET1 DTA123EET1 DTA143EET1 DTA143ZET1 DTA124XET1 DTA123JET1 DTA115EET1 DTA144WET1	$h_{FE}$	35 60 80 80 160 160 8.0 15 80 80 80 80 80	60 100 140 140 250 250 15 27 140 130 140 150 140	– – – – – – – – – – – – –	– – – – – – – – – – – – –
Collector–Emitter Saturation Voltage ( $I_C = 10\text{ mA}$ , $I_E = 0.3\text{ mA}$ ) ( $I_C = 10\text{ mA}$ , $I_B = 5\text{ mA}$ ) ( $I_C = 10\text{ mA}$ , $I_B = 1\text{ mA}$ )	DTA123EET1 DTA114TET1/DTA143TET1 DTA143ZET1/DTA124XET1 DTA143EET1	$V_{CE(sat)}$	–	–	0.25	Vdc
Output Voltage (on) ( $V_{CC} = 5.0\text{ V}$ , $V_B = 2.5\text{ V}$ , $R_L = 1.0\text{ k}\Omega$ )  ( $V_{CC} = 5.0\text{ V}$ , $V_B = 3.5\text{ V}$ , $R_L = 1.0\text{ k}\Omega$ ) ( $V_{CC} = 5.0\text{ V}$ , $V_B = 5.5\text{ V}$ , $R_L = 1.0\text{ k}\Omega$ ) ( $V_{CC} = 5.0\text{ V}$ , $V_B = 4.0\text{ V}$ , $R_L = 1.0\text{ k}\Omega$ )	DTA114EET1 DTA124EET1 DTA114YET1 DTA114TET1 DTA143TET1 DTA123EET1 DTA143EET1 DTA143ZET1 DTA124XET1 DTA123JET1 DTA144EET1 DTA115EET1 DTA144WET1	$V_{OL}$	– – – – – – – – – – – – –	– – – – – – – – – – – – –	0.2 0.2 0.2 0.2 0.2 0.2 0.2 0.2 0.2 0.2 0.2 0.2 0.2	Vdc
Output Voltage (off) ( $V_{CC} = 5.0\text{ V}$ , $V_B = 0.5\text{ V}$ , $R_L = 1.0\text{ k}\Omega$ ) ( $V_{CC} = 5.0\text{ V}$ , $V_B = 0.25\text{ V}$ , $R_L = 1.0\text{ k}\Omega$ )	DTA114TET1 DTA143TET1 DTA123EET1 DTA143EET1	$V_{OH}$	4.9	–	–	Vdc
Input Resistor	DTA114EET1 DTA124EET1 DTA144EET1 DTA114YET1 DTA114TET1 DTA143TET1 DTA123EET1 DTA143EET1 DTA143ZET1 DTA124XET1 DTA123JET1 DTA115EET1 DTA144WET1	$R_1$	7.0 15.4 32.9 7.0 7.0 3.3 1.5 3.3 3.3 15.4 1.54 70 32.9	10 22 47 10 10 4.7 2.2 4.7 4.7 22 2.2 100 47	13 28.6 61.1 13 13 6.1 2.9 6.1 6.1 28.6 2.86 130 61.1	k $\Omega$
Resistor Ratio	DTA114EET1/DTA124EET1 DTA144EET1/DTA115EET1 DTA114YET1 DTA114TET1/DTA143TET1 DTA123EET1/DTA143EET1 DTA143ZET1 DTA124XET1 DTA123JET1 DTA144WET1	$R_1/R_2$	0.8 0.17 – 0.8 0.055 0.38 0.038 1.7	1.0 0.21 – 1.0 0.1 0.47 0.047 2.1	1.2 0.25 – 1.2 0.185 0.56 0.056 2.6	–

4. Pulse Test: Pulse Width < 300  $\mu\text{s}$ , Duty Cycle < 2.0%

# DTA114EET1 Series

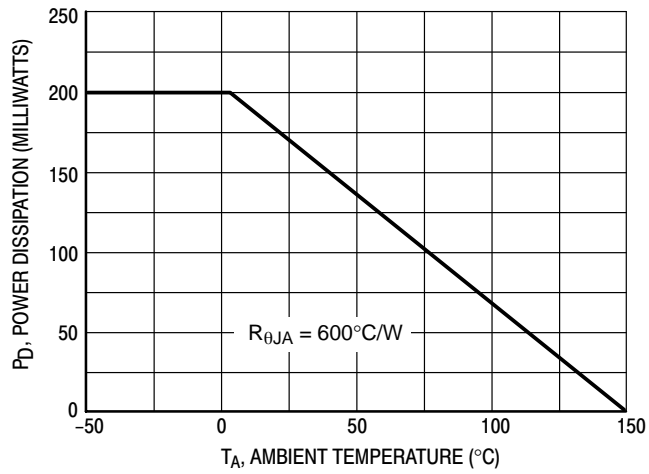

Figure 1. Derating Curve

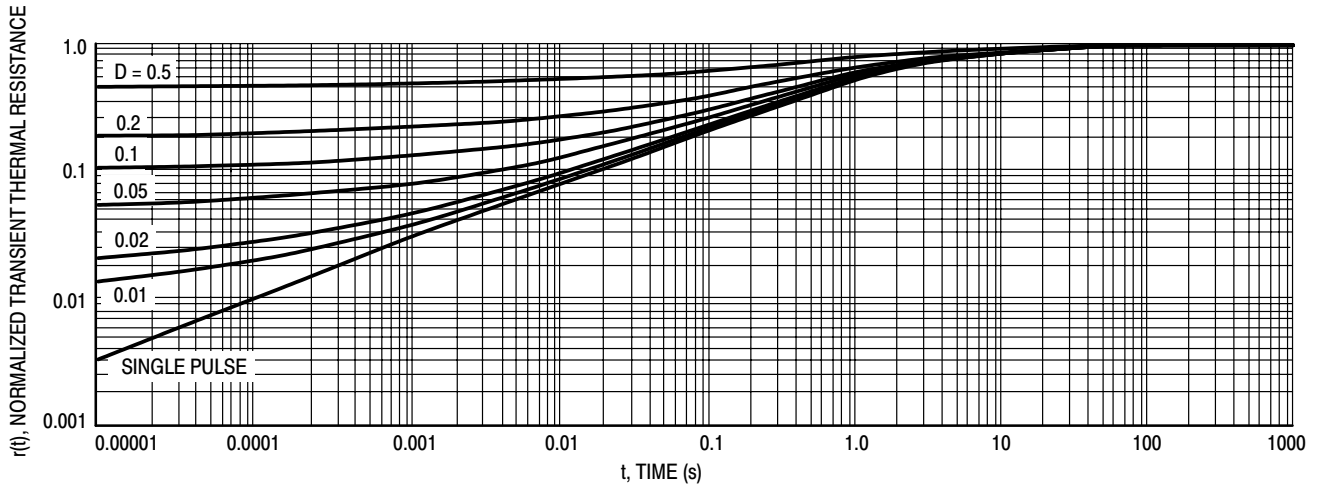

Figure 2. Normalized Thermal Response

# DTA114EET1 Series

## TYPICAL ELECTRICAL CHARACTERISTICS – DTA114EET1

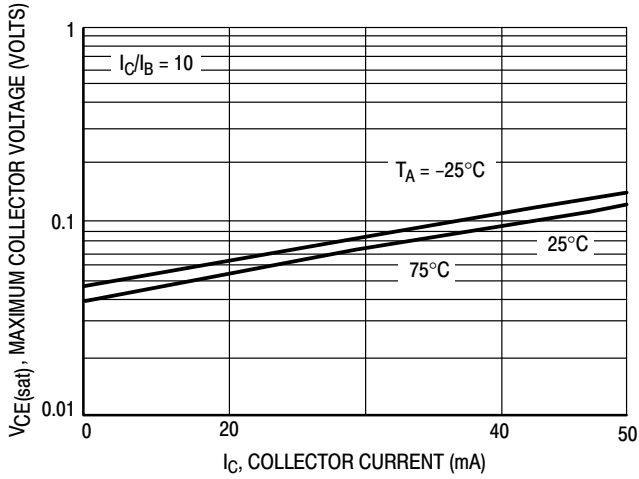

Figure 3.  $V_{CE(sat)}$  versus  $I_C$

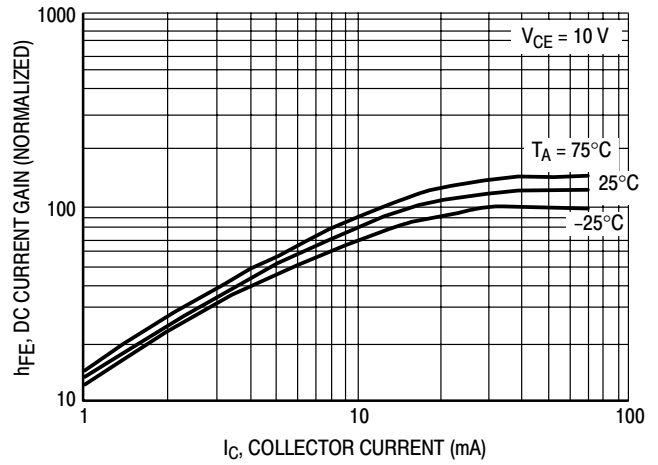

Figure 4. DC Current Gain

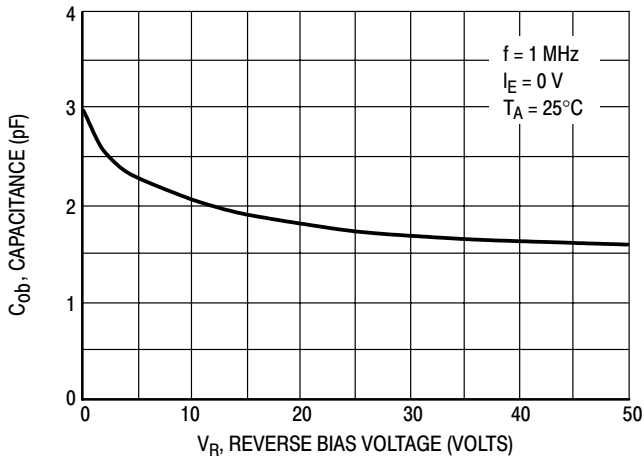

Figure 5. Output Capacitance

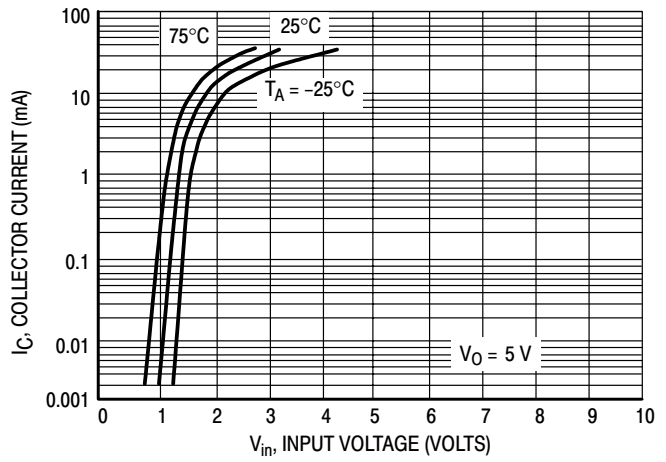

Figure 6. Output Current versus Input Voltage

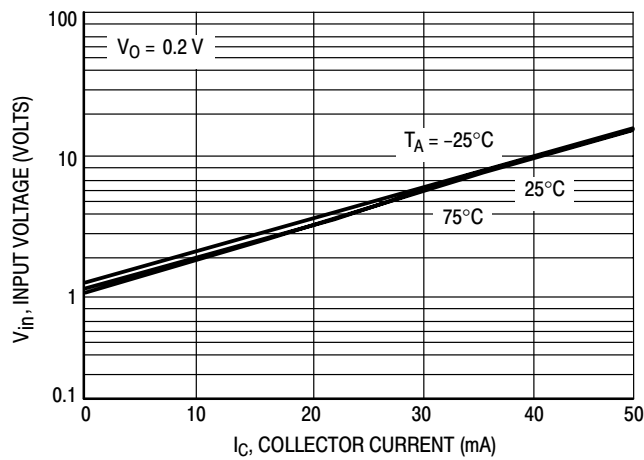

Figure 7. Input Voltage versus Output Current

# DTA114EET1 Series

## TYPICAL ELECTRICAL CHARACTERISTICS – DTA124EET1

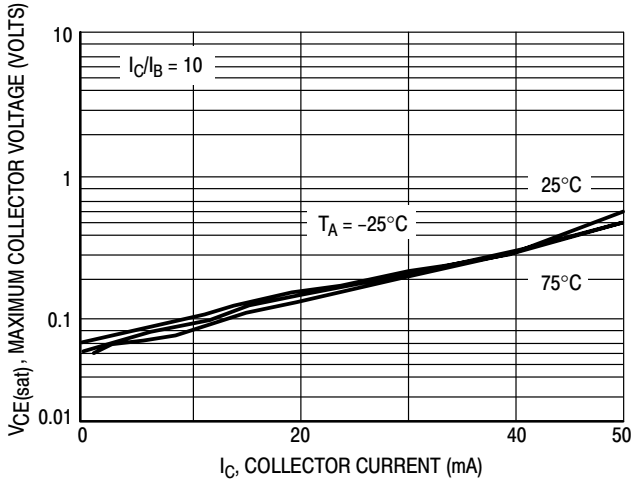

Figure 8.  $V_{CE(sat)}$  versus  $I_C$

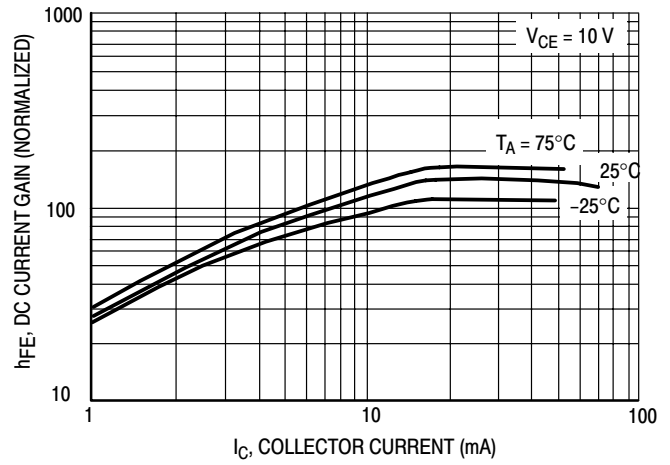

Figure 9. DC Current Gain

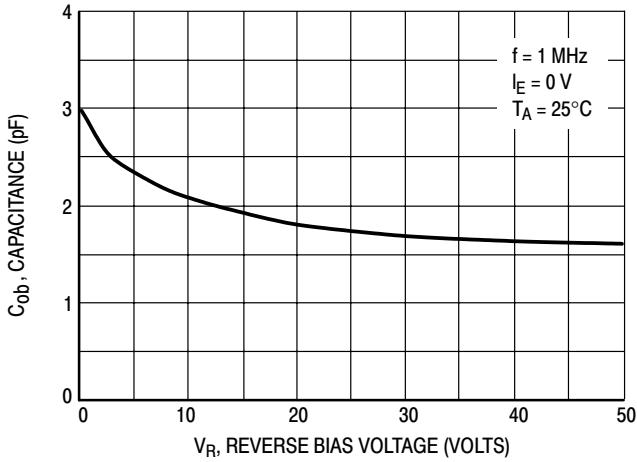

Figure 10. Output Capacitance

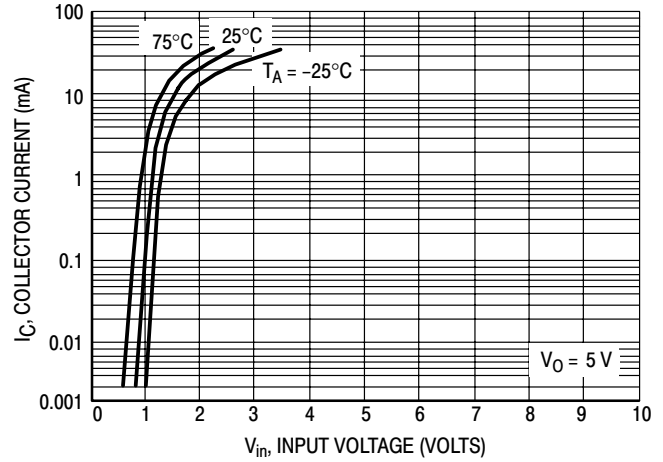

Figure 11. Output Current versus Input Voltage

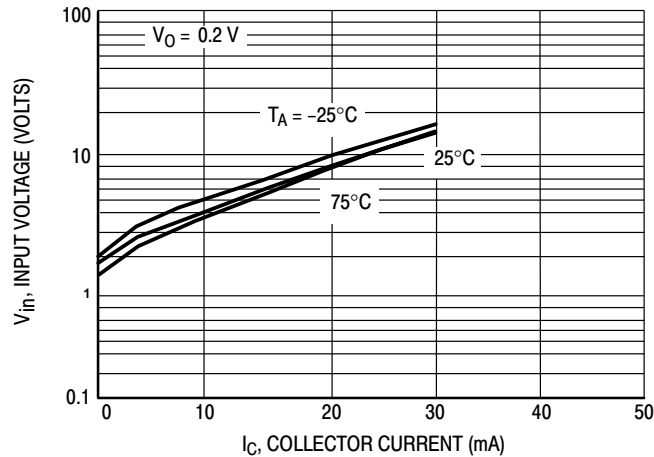

Figure 12. Input Voltage versus Output Current

# DTA114EET1 Series

## TYPICAL ELECTRICAL CHARACTERISTICS – DTA144EET1

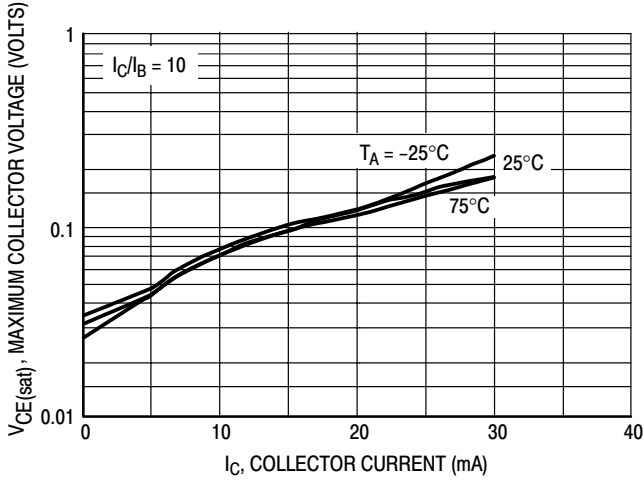

Figure 13.  $V_{CE(sat)}$  versus  $I_C$

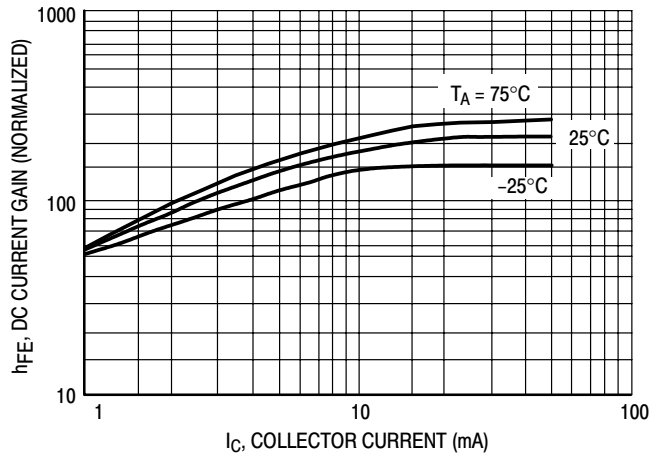

Figure 14. DC Current Gain

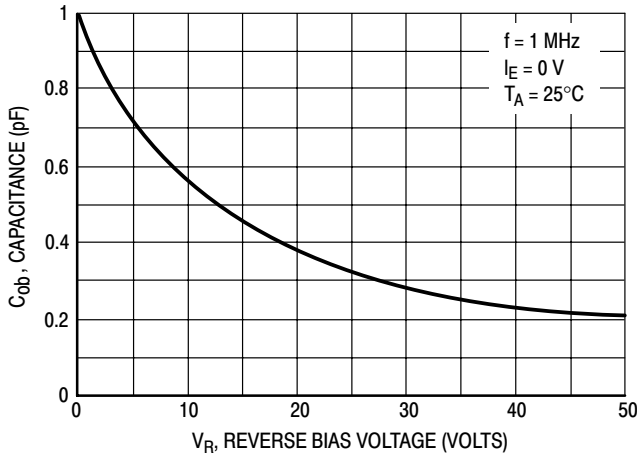

Figure 15. Output Capacitance

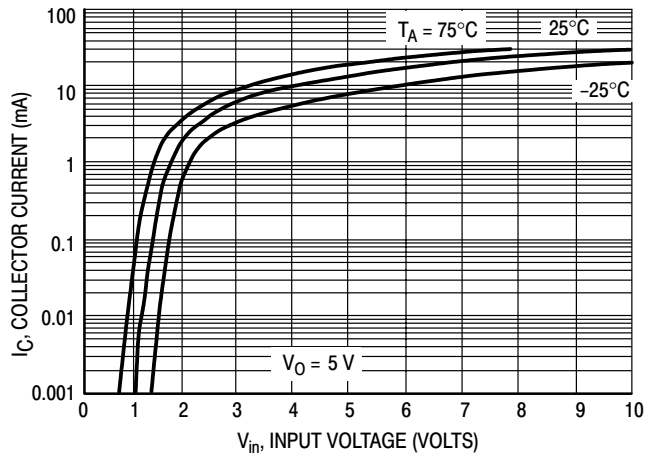

Figure 16. Output Current versus Input Voltage

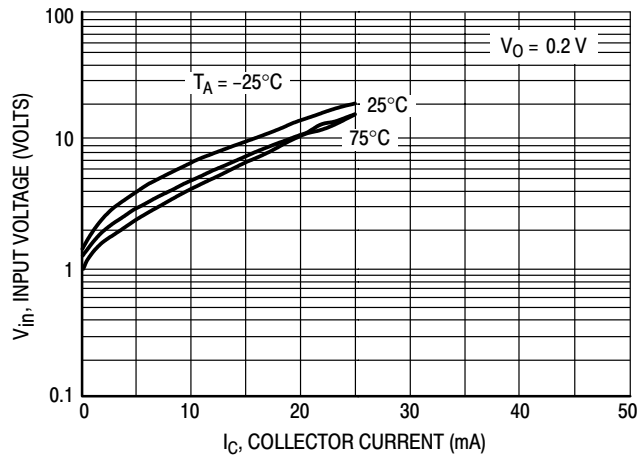

Figure 17. Input Voltage versus Output Current

TYPICAL ELECTRICAL CHARACTERISTICS – DTA114YET1

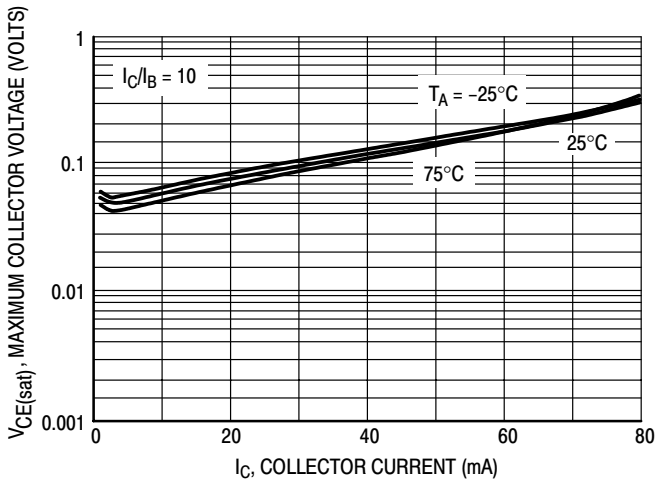

Figure 18.  $V_{CE(sat)}$  versus  $I_C$

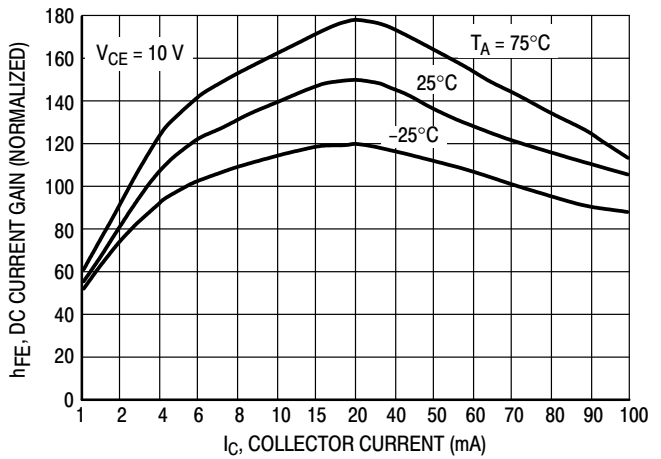

Figure 19. DC Current Gain

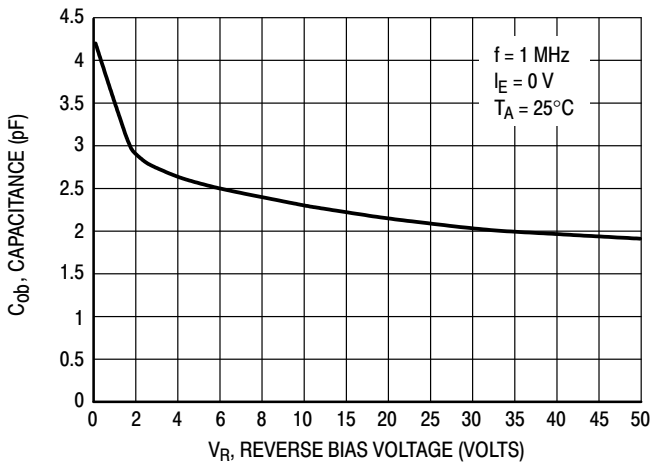

Figure 20. Output Capacitance

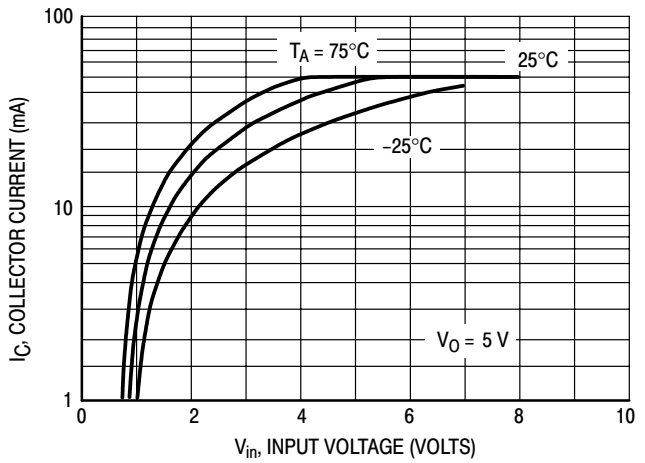

Figure 21. Output Current versus Input Voltage

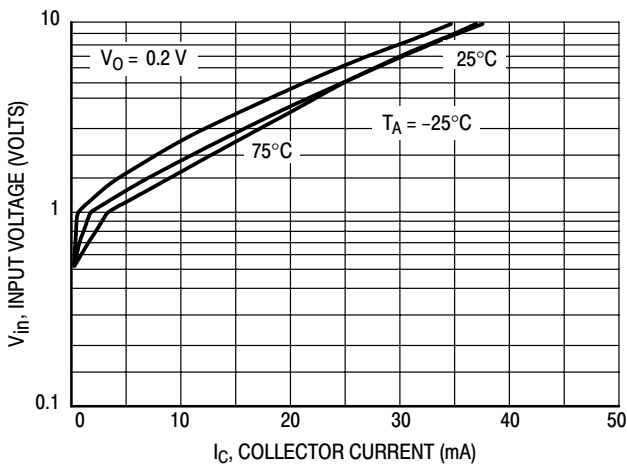

Figure 22. Input Voltage versus Output Current

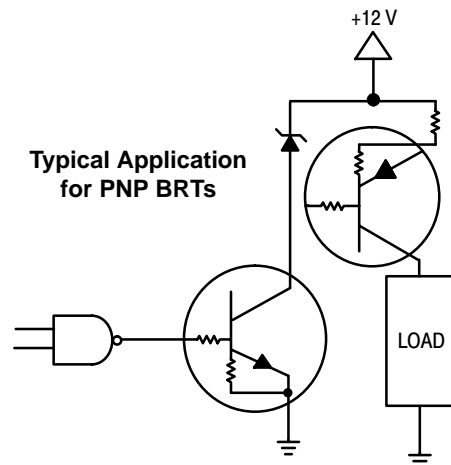
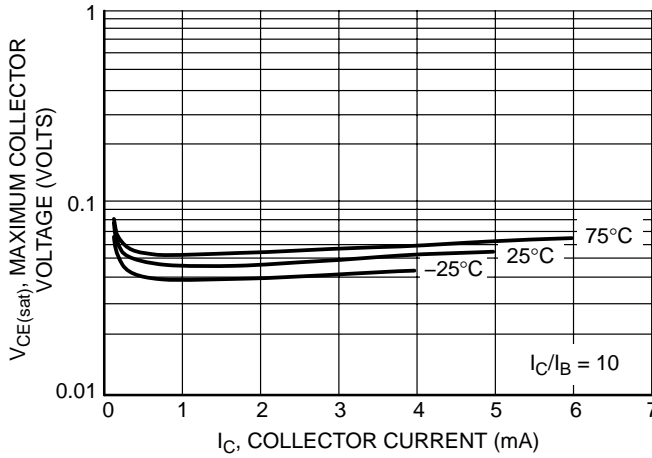

Figure 23. Inexpensive, Unregulated Current Source



# DTA114EET1 Series

## TYPICAL ELECTRICAL CHARACTERISTICS — DTA115EET1



**Figure 24. Maximum Collector Voltage versus Collector Current**

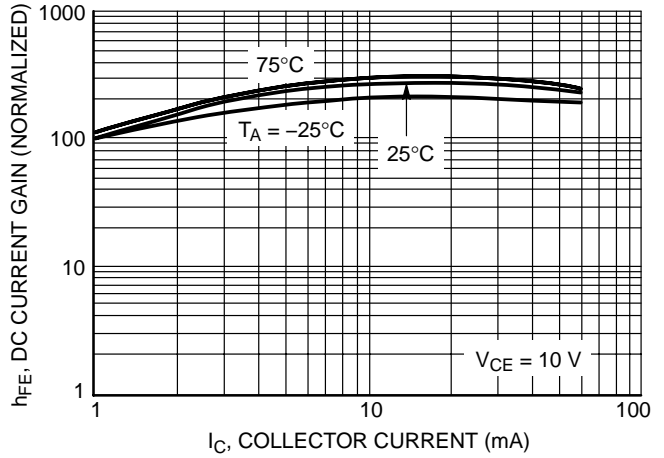

**Figure 25. DC Current Gain**

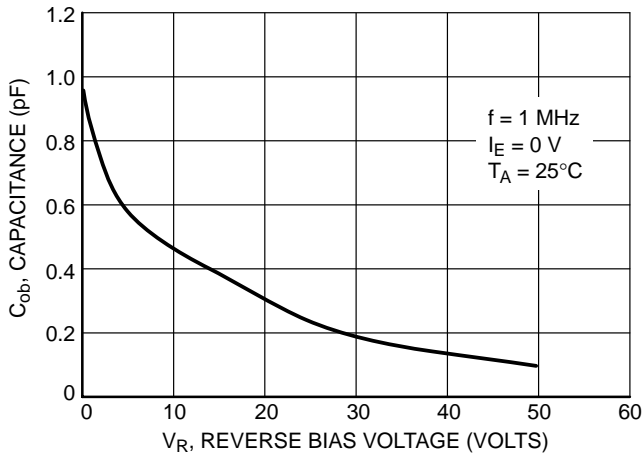

**Figure 26. Output Capacitance**

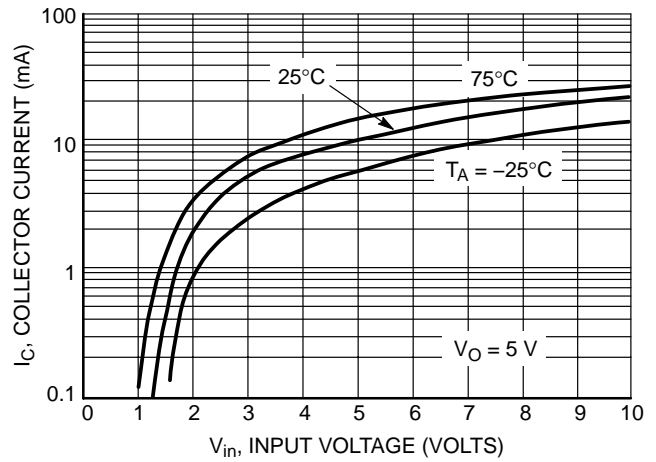

**Figure 27. Output Current versus Input Voltage**

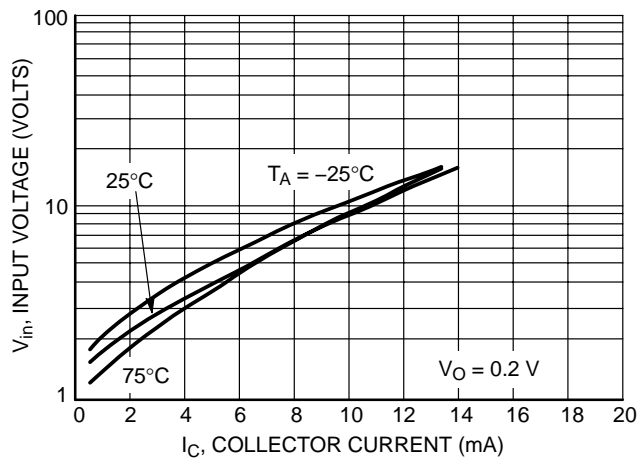

**Figure 28. Input Voltage versus Output Current**

# DTA114EET1 Series

## TYPICAL ELECTRICAL CHARACTERISTICS — DTA144WET1

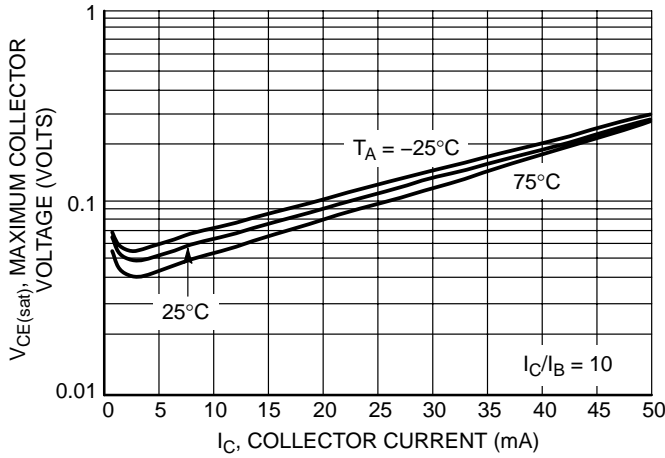

**Figure 29. Maximum Collector Voltage versus Collector Current**

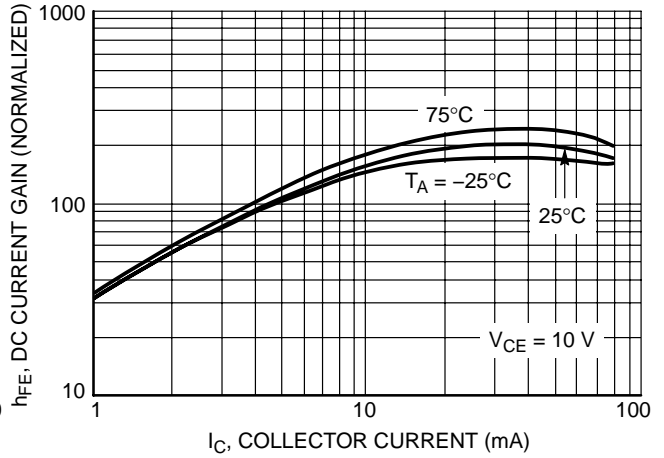

**Figure 30. DC Current Gain**

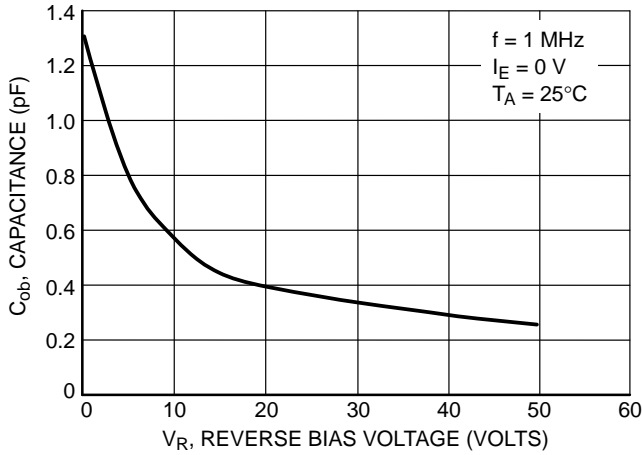

**Figure 31. Output Capacitance**

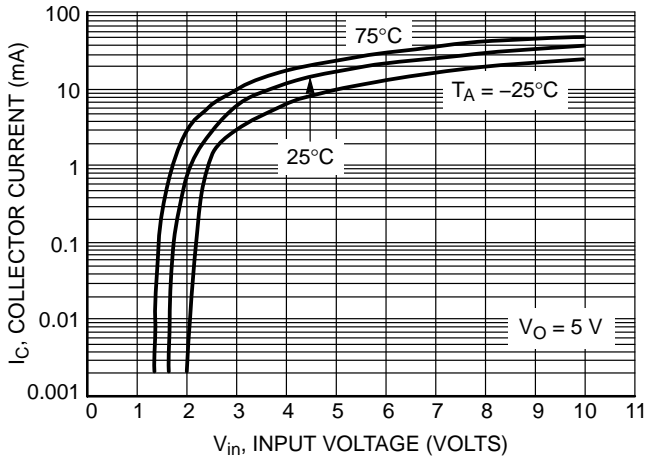

**Figure 32. Output Current versus Input Voltage**

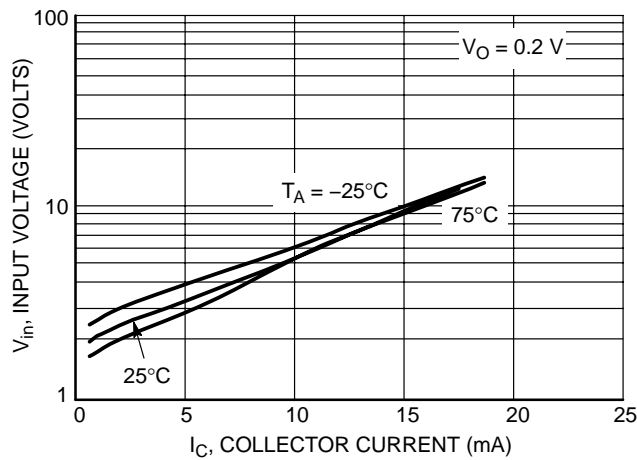
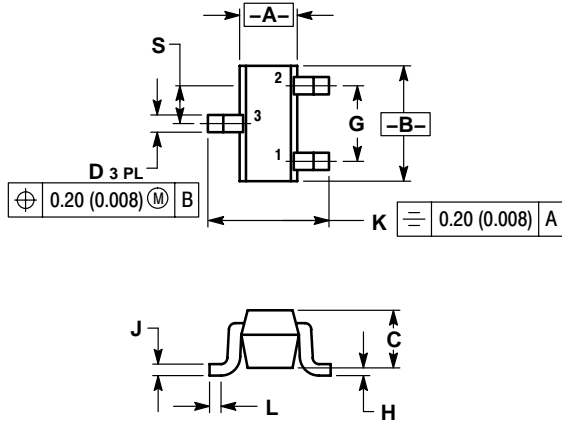

**Figure 33. Input Voltage versus Output Current**

# DTA114EET1 Series

## PACKAGE DIMENSIONS

SC-75/SOT-416  
CASE 463-01  
ISSUE C



NOTES:

1. DIMENSIONING AND TOLERANCING PER ANSI Y14.5M, 1982.
2. CONTROLLING DIMENSION: MILLIMETER.

DIM	MILLIMETERS		INCHES	
	MIN	MAX	MIN	MAX
A	0.70	0.90	0.028	0.035
B	1.40	1.80	0.055	0.071
C	0.60	0.90	0.024	0.035
D	0.15	0.30	0.006	0.012
G	1.00 BSC		0.039 BSC	
H	---	0.10	---	0.004
J	0.10	0.25	0.004	0.010
K	1.45	1.75	0.057	0.069
L	0.10	0.20	0.004	0.008
S	0.50 BSC		0.020 BSC	

STYLE 1:

- PIN 1. BASE
- EMITTER
- COLLECTOR

### SOLDERING FOOTPRINT\*

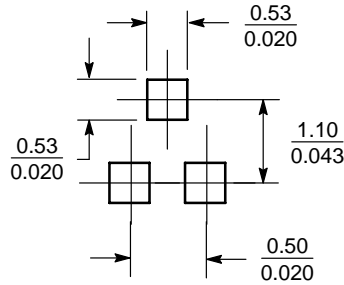

SCALE 10:1  $\left(\frac{\text{mm}}{\text{inches}}\right)$

\*For additional information on our Pb-Free strategy and soldering details, please download the ON Semiconductor Soldering and Mounting Techniques Reference Manual, SOLDERRM/D.

# DTA114EET1 Series

**ON Semiconductor** and  are registered trademarks of Semiconductor Components Industries, LLC (SCILLC). SCILLC reserves the right to make changes without further notice to any products herein. SCILLC makes no warranty, representation or guarantee regarding the suitability of its products for any particular purpose, nor does SCILLC assume any liability arising out of the application or use of any product or circuit, and specifically disclaims any and all liability, including without limitation special, consequential or incidental damages. "Typical" parameters which may be provided in SCILLC data sheets and/or specifications can and do vary in different applications and actual performance may vary over time. All operating parameters, including "Typicals" must be validated for each customer application by customer's technical experts. SCILLC does not convey any license under its patent rights nor the rights of others. SCILLC products are not designed, intended, or authorized for use as components in systems intended for surgical implant into the body, or other applications intended to support or sustain life, or for any other application in which the failure of the SCILLC product could create a situation where personal injury or death may occur. Should Buyer purchase or use SCILLC products for any such unintended or unauthorized application, Buyer shall indemnify and hold SCILLC and its officers, employees, subsidiaries, affiliates, and distributors harmless against all claims, costs, damages, and expenses, and reasonable attorney fees arising out of, directly or indirectly, any claim of personal injury or death associated with such unintended or unauthorized use, even if such claim alleges that SCILLC was negligent regarding the design or manufacture of the part. SCILLC is an Equal Opportunity/Affirmative Action Employer. This literature is subject to all applicable copyright laws and is not for resale in any manner.

## PUBLICATION ORDERING INFORMATION

### LITERATURE FULFILLMENT:

Literature Distribution Center for ON Semiconductor  
P.O. Box 61312, Phoenix, Arizona 85082-1312 USA  
**Phone:** 480-829-7710 or 800-344-3860 Toll Free USA/Canada  
**Fax:** 480-829-7709 or 800-344-3867 Toll Free USA/Canada  
**Email:** [orderlit@onsemi.com](mailto:orderlit@onsemi.com)

**N. American Technical Support:** 800-282-9855 Toll Free  
USA/Canada

**Japan:** ON Semiconductor, Japan Customer Focus Center  
2-9-1 Kamimeguro, Meguro-ku, Tokyo, Japan 153-0051  
**Phone:** 81-3-5773-3850

**ON Semiconductor Website:** <http://onsemi.com>

**Order Literature:** <http://www.onsemi.com/litorder>

For additional information, please contact your  
local Sales Representative.