

PHOTOCOUPLER

PS2532-1,-2,-4,PS2532L-1,-2,-4

HIGH COLLECTOR TO EMITTER VOLTAGE HIGH ISOLATION VOLTAGE MULTI PHOTOCOUPLER SERIES

-NEPOC™ Series-

DESCRIPTION

The PS2532-1, -2, -4 and PS2532L-1, -2, -4 are optically coupled isolators containing a GaAs light emitting diode and an NPN silicon darlington connected phototransistor.

The PS2532-1, -2, -4 are in a plastic DIP (Dual In-line Package) and the PS2532L-1, -2, -4 are lead bending type (Gull-wing) for surface mount.

★ FEATURES

- High collector to emitter voltage ($V_{CEO} = 300 \text{ V}$)
- High Isolation voltage $BV = 5\,000 \text{ Vr.m.s.}$: standard products
 $BV = 3\,750 \text{ Vr.m.s.}$: VDE0884 approved products (Option)
- High current transfer ratio ($CTR = 4\,000 \%$ TYP.)
- High-speed switching ($t_r, t_f = 100 \mu\text{s}$ TYP.)
- Ordering number of taping product: PS2532L-1-E3, E4, F3, F4, PS2532L-2-E3, E4
- UL approved: File No. E72422 (S)
- BSI approved: No. 8221/8222
- NEMKO approved: No. 98101708
- SEMKO approved: No. 9824187/01-02
- DEMKO approved: No. 307863
- FIMKO approved: No. F1 11397
- VDE0884 approved (Option)

APPLICATIONS

- Telephone, Exchange equipment
- FAX/MODEM

The information in this document is subject to change without notice.

★ PACKAGE DIMENSIONS (in millimeters)

DIP type

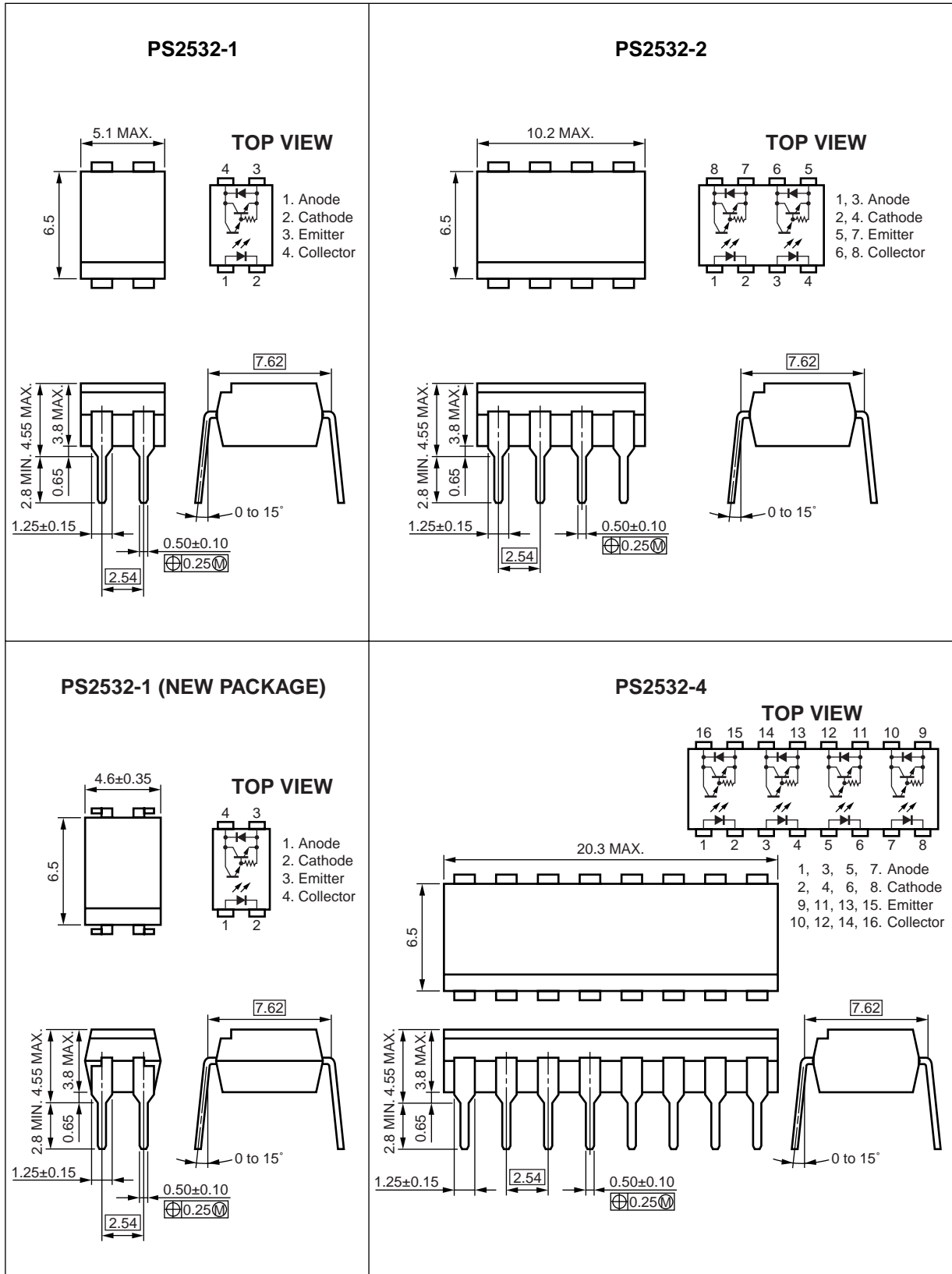

Lead bending type

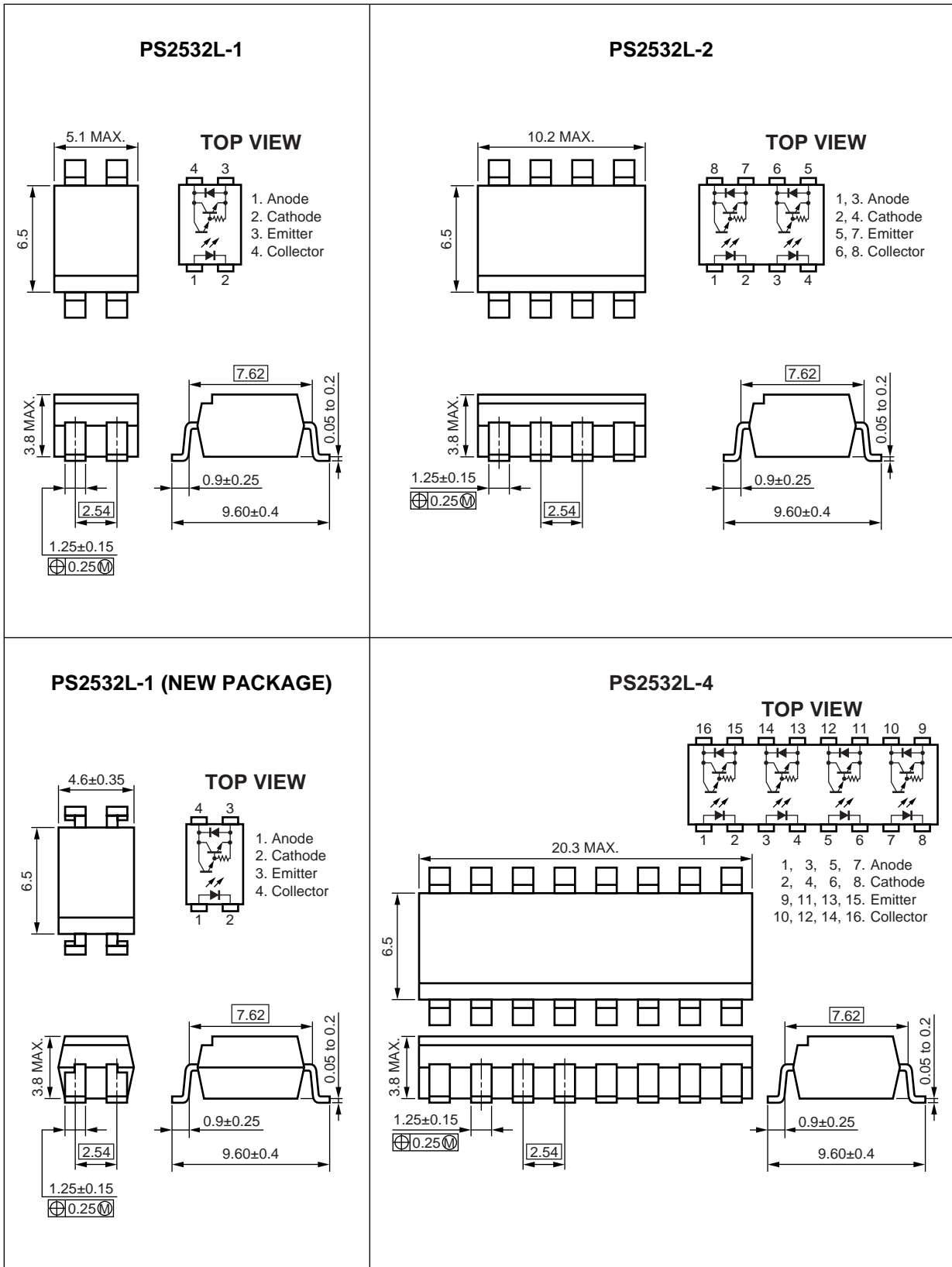

Lead bending type for long distance

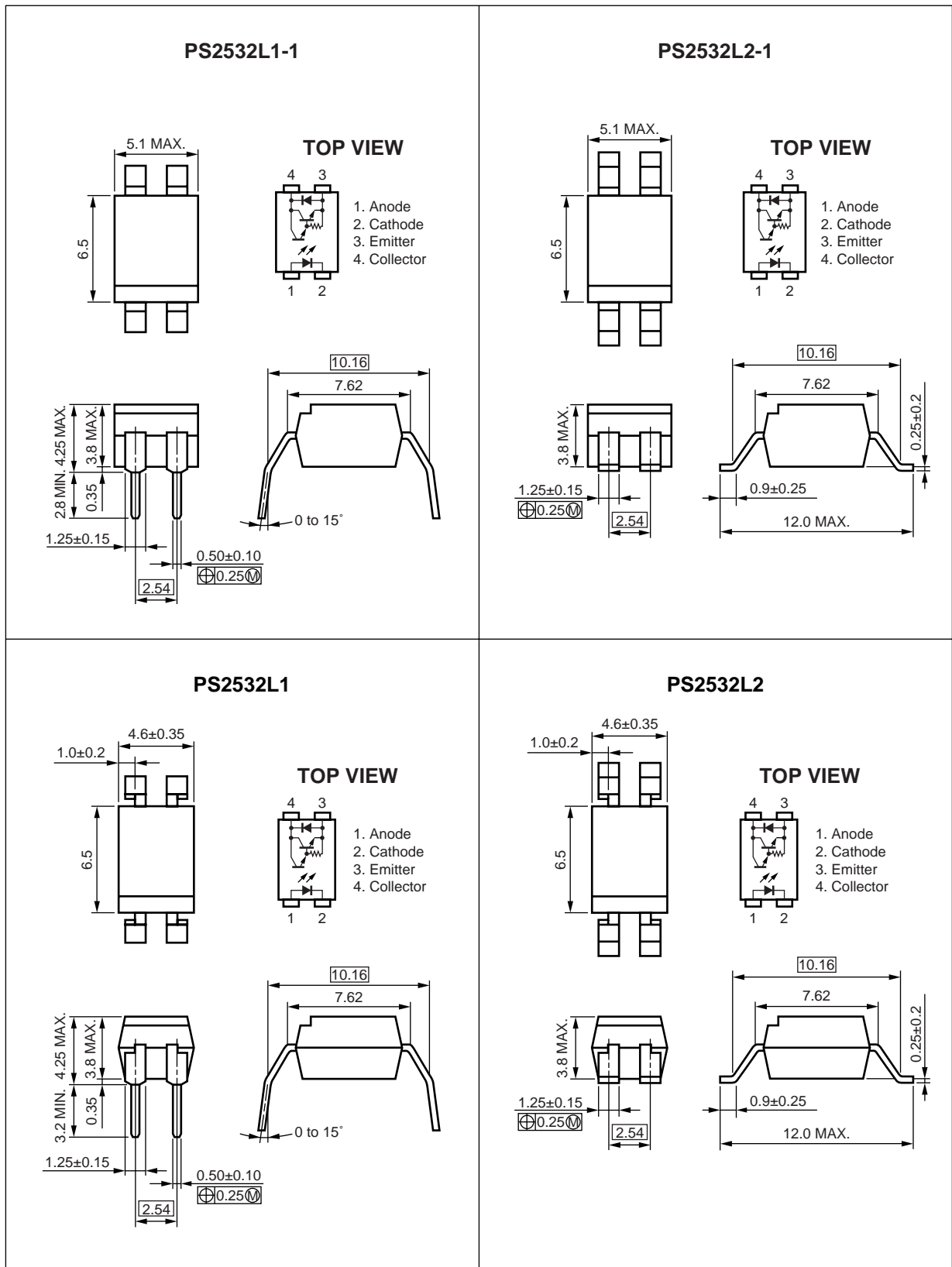

★ **ORDERING INFORMATION**

Part Number	Package	Safety Standard Approval	Application Part Number ^{*1}
PS2532-1 PS2532L-1 PS2532L1-1 PS2532L2-1	4-pin DIP 4-pin DIP (lead bending surface mount) 4-pin DIP (for long distance) 4-pin DIP (for long distance surface mount)	Standard products (UL, BSI, NEMKO, SEMKO, DEMKO, FIMKO approved)	PS2532-1
PS2532-2 PS2532L-2	8-pin DIP 8-pin DIP (lead bending surface mount)		PS2532-2
PS2532-4 PS2532L-4	16-pin DIP 16-pin DIP (lead bending surface mount)		PS2532-4
PS2532-1-V PS2532L-1-V PS2532L1-1-V PS2532L2-1-V	4-pin DIP 4-pin DIP (lead bending surface mount) 4-pin DIP (for long distance) 4-pin DIP (for long distance surface mount)	VDE0884 approved products (Option)	PS2532-1
PS2532-2-V PS2532L-2-V	8-pin DIP 8-pin DIP (lead bending surface mount)		PS2532-2
PS2532-4-V PS2532L-4-V	16-pin DIP 16-pin DIP (lead bending surface mount)		PS2532-4

*1 As applying to Safety Standard, following part number should be used.

ABSOLUTE MAXIMUM RATINGS (T_A = 25 °C, unless otherwise specified)

Parameter		Symbol	Ratings		Unit
			PS2532-1, PS2532L-1	PS2532-2, -4, PS2532L-2, -4	
Diode	Forward Current (DC)	I _F	80		mA
	Reverse Voltage	V _R	6		V
	Power Dissipation Derating	ΔP _D /°C	1.5	1.2	mW/°C
	Power Dissipation	P _D	150	120	mW/ch
	Peak Forward Current ^{*1}	I _{FP}	1		A
Transistor	Collector to Emitter Voltage	V _{CEO}	300		V
	Emitter to Collector Voltage	V _{ECO}	0.6		V
	Collector Current	I _C	150		mA/ch
	Power Dissipation Derating	ΔP _C /°C	3.0	2.4	mW/°C
	Power Dissipation	P _C	300	240	mW/ch
Isolation Voltage ^{*2}		BV	5 000 3 750 ^{*3}		Vr.m.s.
Operating Ambient Temperature		T _A	-55 to +100		°C
Storage Temperature		T _{stg}	-55 to +150		°C

*1 PW = 100 μs, Duty Cycle = 1 %

*2 AC voltage for 1 minute at T_A = 25 °C, RH = 60 % between input and output

*3 VDE0884 approved products (Option)

ELECTRICAL CHARACTERISTICS (T_A = 25 °C)

Parameter		Symbol	Conditions	MIN.	TYP.	MAX.	Unit
Diode	Forward Voltage	V _F	I _F = 10 mA		1.15	1.40	V
	Reverse Current	I _R	V _R = 5 V			5	μA
	Terminal Capacitance	C _t	V = 0 V, f = 1.0 MHz		30		pF
Transistor	Collector to Emitter Dark Current	I _{CEO}	V _{CE} = 300 V, I _F = 0 mA			400	nA
Coupled	Current Transfer Ratio (I _c /I _F)	CTR	I _F = 1 mA, V _{CE} = 2 V	1 500	4 000	6 500	%
	Collector Saturation Voltage	V _{CE(sat)}	I _F = 1 mA, I _c = 2 mA			1.0	V
	Isolation Resistance	R _{I-O}	V _{I-O} = 1.0 kV _{DC}	10 ¹¹			Ω
	Isolation Capacitance	C _{I-O}	V = 0 V, f = 1.0 MHz		0.6		pF
	Rise Time ^{*1}	t _r	V _{CC} = 5 V, I _c = 10 mA, R _L = 100 Ω		100		μs
	Fall Time ^{*1}	t _f			100		

*1 Test circuit for switching time

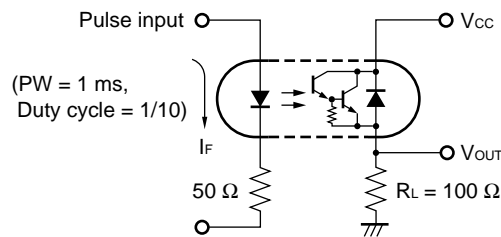

TYPICAL CHARACTERISTICS (T_A = 25 °C, unless otherwise specified)

DIODE POWER DISSIPATION vs. AMBIENT TEMPERATURE

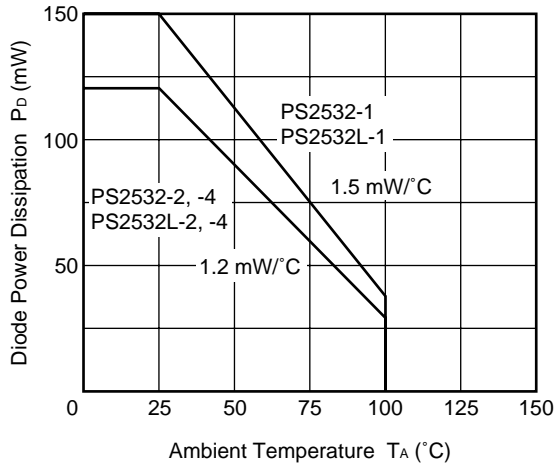

TRANSISTOR POWER DISSIPATION vs. AMBIENT TEMPERATURE

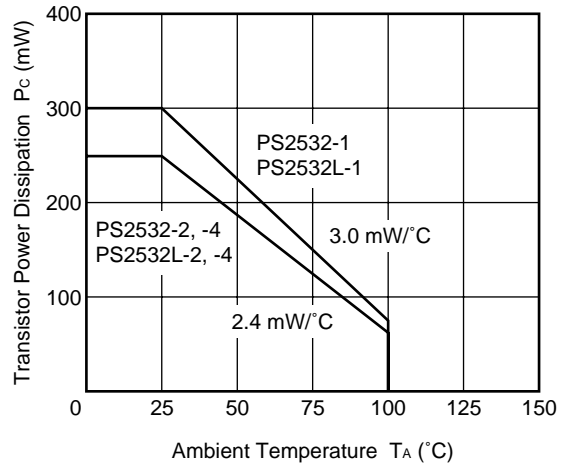

FORWARD CURRENT vs. FORWARD VOLTAGE

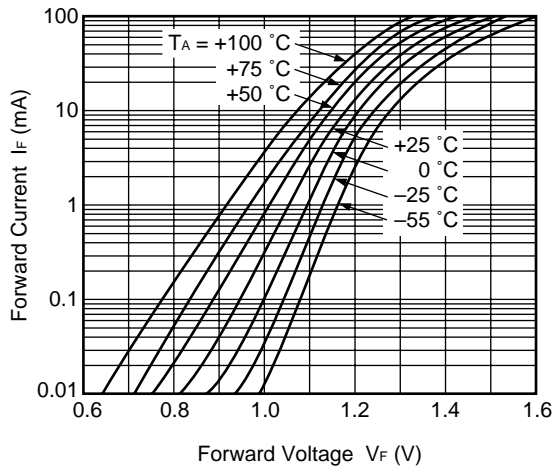

COLLECTOR CURRENT vs. COLLECTOR TO EMITTER VOLTAGE

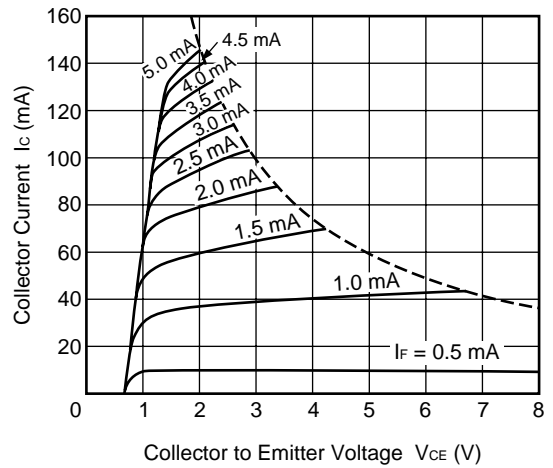

COLLECTOR TO EMITTER DARK CURRENT vs. AMBIENT TEMPERATURE

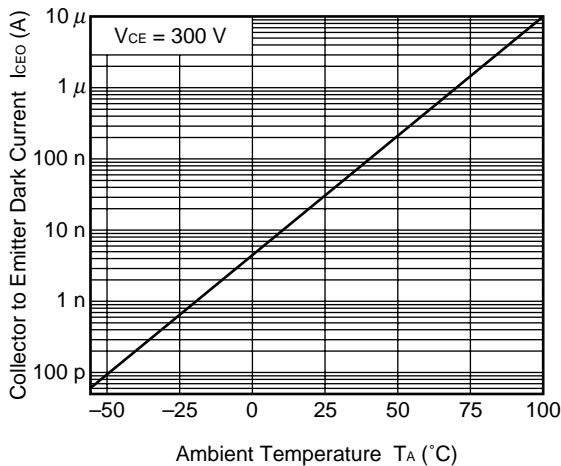

COLLECTOR CURRENT vs. COLLECTOR SATURATION VOLTAGE

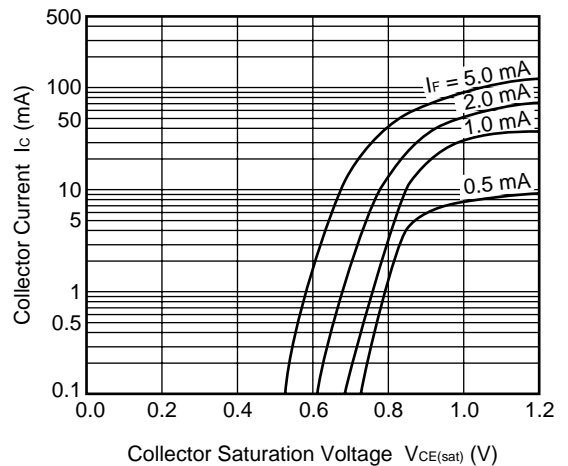

NORMALIZED CURRENT TRANSFER RATIO vs. AMBIENT TEMPERATURE

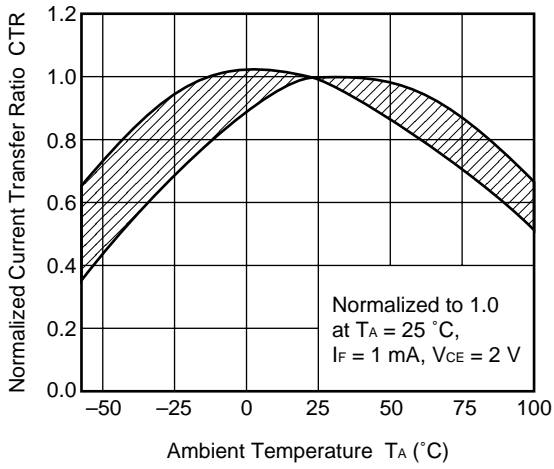

CURRENT TRANSFER RATIO vs. FORWARD CURRENT

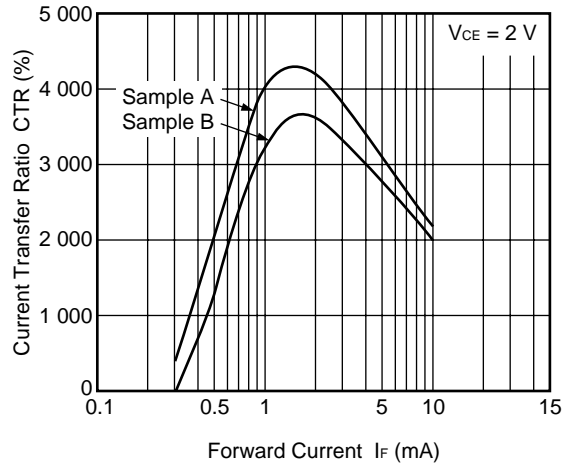

SWITCHING TIME vs. LOAD RESISTANCE

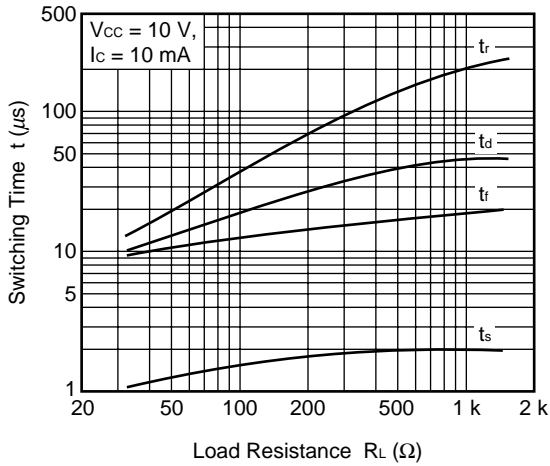

FREQUENCY RESPONSE

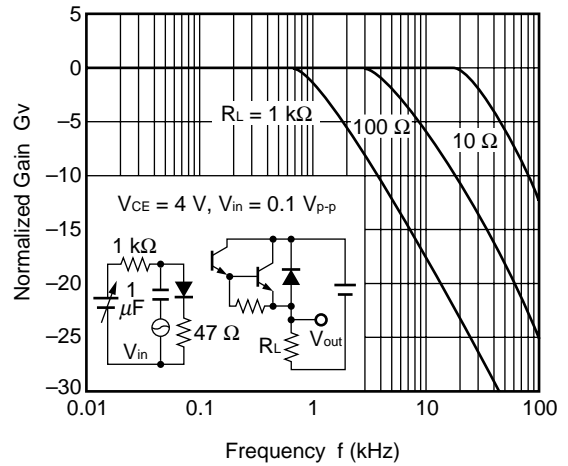

LONG TERM CTR DEGRADATION

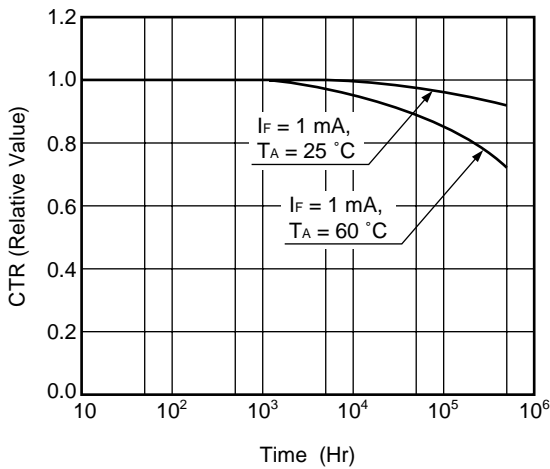

Remark The graphs indicate nominal characteristics.

TAPING SPECIFICATIONS (in millimeters)

Outline and Dimensions (Tape)

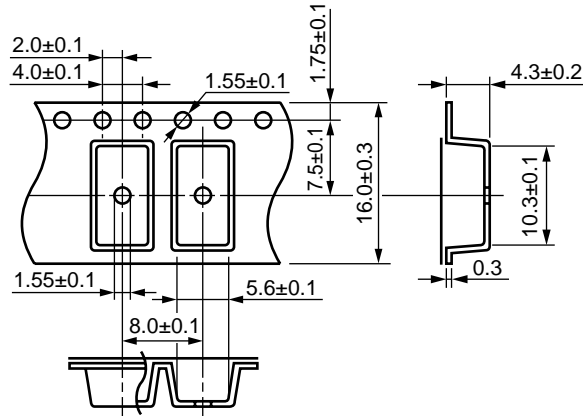

Tape Direction

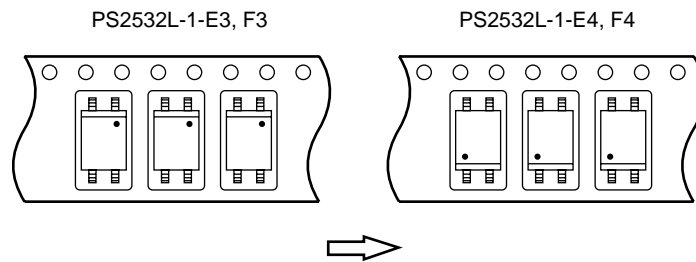

Outline and Dimensions (Reel)

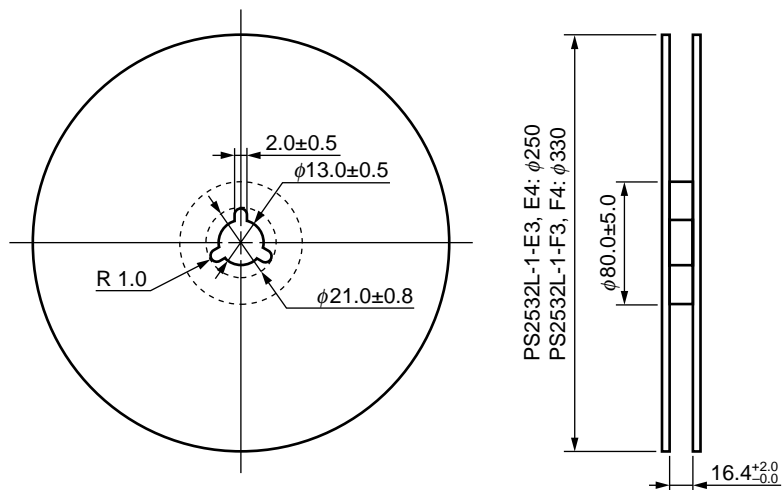

Packing: PS2532L-1-E3, E4 1 000 pcs/reel
 PS2532L-1-F3, F4 2 000 pcs/reel

Outline and Dimensions (Tape)

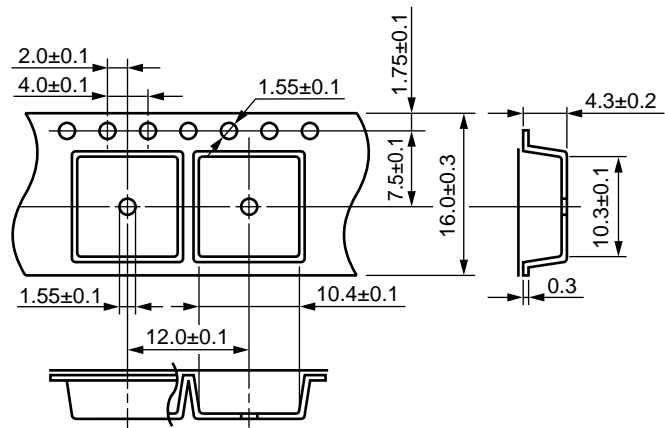

Tape Direction

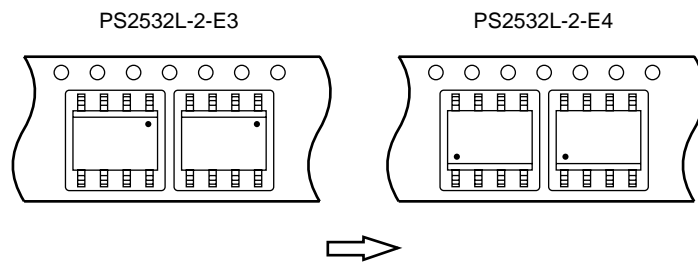

Outline and Dimensions (Reel)

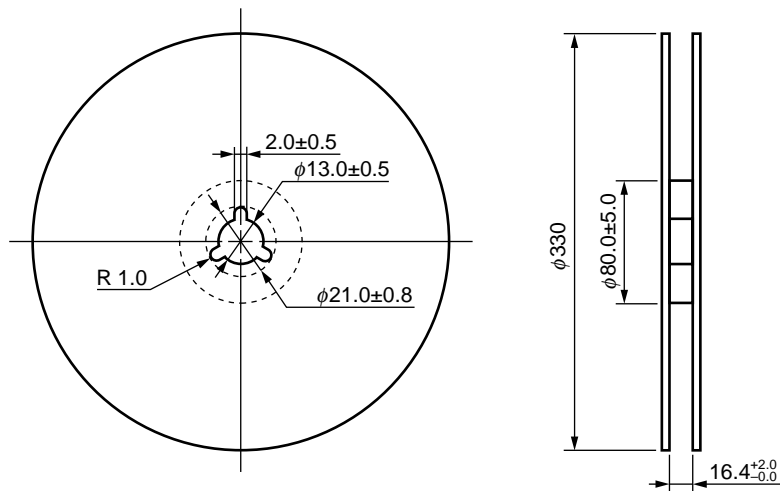

Packing: 1 000 pcs/reel

RECOMMENDED SOLDERING CONDITIONS

(1) Infrared reflow soldering

- Peak reflow temperature 235 °C (package surface temperature)
- Time of temperature higher than 210 °C 30 seconds or less
- Number of reflows Three
- Flux Rosin flux containing small amount of chlorine (The flux with a maximum chlorine content of 0.2 Wt % is recommended.)

Recommended Temperature Profile of Infrared Reflow

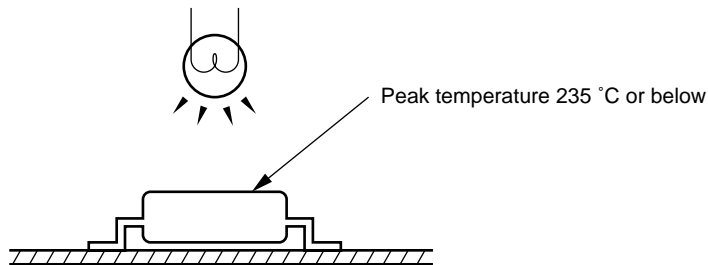
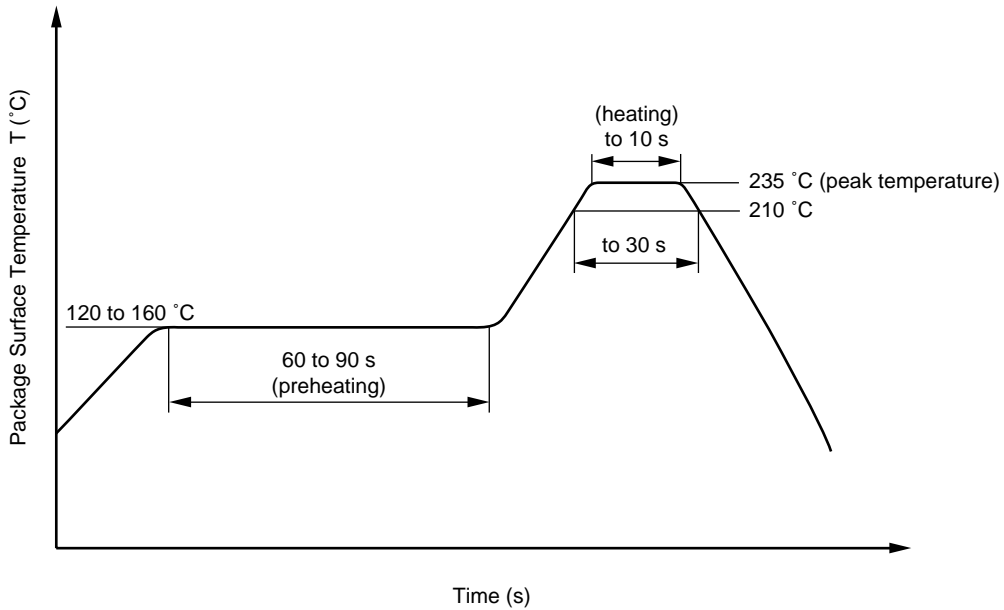

(2) Dip soldering

- Temperature 260 °C or below (molten solder temperature)
- Time 10 seconds or less
- Number of times One
- Flux Rosin flux containing small amount of chlorine (The flux with a maximum chlorine content of 0.2 Wt % is recommended.)

(3) Cautions

- Fluxes
Avoid removing the residual flux with freon-based and chlorine-based cleaning solvent.

SPECIFICATION OF VDE MARKS LICENSE DOCUMENT (VDE0884)

Parameter	Symbol	Speck	Unit
Application classification (DIN VDE 0109) for rated line voltages ≤ 300 Vr.m.s. for rated line voltages ≤ 600 Vr.m.s.		IV III	
Climatic test class (DIN IEC 68 Teil 1/09.80)		55/100/21	
Dielectric strength maximum operating isolation voltage Test voltage (partial discharge test, procedure a for type test and random test) $U_{pr} = 1.2 \times U_{IORM}, P_d < 5$ pC	U_{IORM} U_{pr}	890 1 068	V_{peak} V_{peak}
Test voltage (partial discharge test, procedure b for random test) $U_{pr} = 1.6 \times U_{IORM}, P_d < 5$ pC	U_{pr}	1 424	V_{peak}
Highest permissible overvoltage	U_{TR}	6 000	V_{peak}
Degree of pollution (DIN VDE 0109)		2	
Clearance distance		> 7.0	mm
Creepage distance		> 7.0	mm
Comparative tracking index (DIN IEC 112/VDE 0303 part 1)	CTI	175	
Material group (DIN VDE 0109)		III a	
Storage temperature range	T_{stg}	-55 to +150	°C
Operating temperature range	T_A	-55 to +100	°C
Isolation resistance, minimum value $V_{IO} = 500$ V dc at $T_A = 25$ °C $V_{IO} = 500$ V dc at T_A MAX. at least 100 °C	Ris MIN. Ris MIN.	10^{12} 10^{11}	Ω Ω
Safety maximum ratings (maximum permissible in case of fault, see thermal derating curve) Package temperature Current (input current $I_F, P_{si} = 0$) Power (output or total power dissipation) Isolation resistance $V_{IO} = 500$ V dc at $T_A = 175$ °C (T_{si})	T_{si} I_{si} P_{si} Ris MIN.	175 400 700 10^9	°C mA mW Ω

APPLICATION FOR TELEPHONE (EXAMPLE)

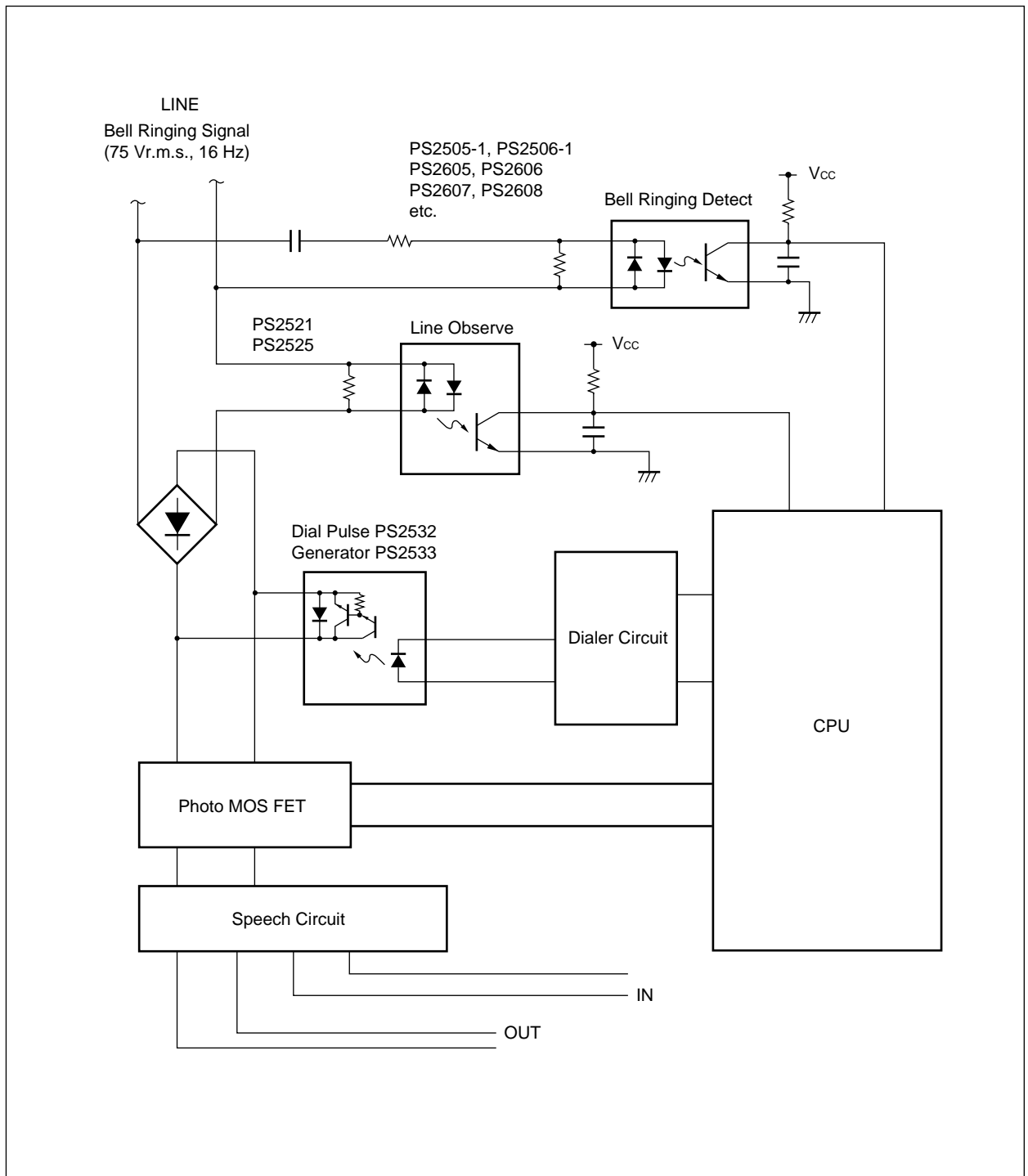

[MEMO]

CAUTION

Within this device there exists GaAs (Gallium Arsenide) material which is a harmful substance if ingested. Please do not under any circumstances break the hermetic seal.

NEPOC is a trademark of NEC Corporation.

No part of this document may be copied or reproduced in any form or by any means without the prior written consent of NEC Corporation. NEC Corporation assumes no responsibility for any errors which may appear in this document.

NEC Corporation does not assume any liability for infringement of patents, copyrights or other intellectual property rights of third parties by or arising from use of a device described herein or any other liability arising from use of such device. No license, either express, implied or otherwise, is granted under any patents, copyrights or other intellectual property rights of NEC Corporation or others.

While NEC Corporation has been making continuous effort to enhance the reliability of its semiconductor devices, the possibility of defects cannot be eliminated entirely. To minimize risks of damage or injury to persons or property arising from a defect in an NEC semiconductor device, customers must incorporate sufficient safety measures in its design, such as redundancy, fire-containment, and anti-failure features.

NEC devices are classified into the following three quality grades:

"Standard", "Special", and "Specific". The Specific quality grade applies only to devices developed based on a customer designated "quality assurance program" for a specific application. The recommended applications of a device depend on its quality grade, as indicated below. Customers must check the quality grade of each device before using it in a particular application.

Standard: Computers, office equipment, communications equipment, test and measurement equipment, audio and visual equipment, home electronic appliances, machine tools, personal electronic equipment and industrial robots

Special: Transportation equipment (automobiles, trains, ships, etc.), traffic control systems, anti-disaster systems, anti-crime systems, safety equipment and medical equipment (not specifically designed for life support)

Specific: Aircrafts, aerospace equipment, submersible repeaters, nuclear reactor control systems, life support systems or medical equipment for life support, etc.

The quality grade of NEC devices is "Standard" unless otherwise specified in NEC's Data Sheets or Data Books. If customers intend to use NEC devices for applications other than those specified for Standard quality grade, they should contact an NEC sales representative in advance.

Anti-radioactive design is not implemented in this product.