

PHOTOCOUPLER
PS2505-1,-2,-4, PS2505L-1,-2,-4**HIGH ISOLATION VOLTAGE
AC INPUT RESPONSE TYPE
MULTI PHOTOCOUPLER SERIES**

-NEPOC™ Series-

DESCRIPTION

The PS2505-1, -2, -4 and PS2505L-1, -2, -4 are optically coupled isolators containing GaAs light emitting diodes and an NPN silicon phototransistor.

The PS2505-1, -2, -4 are in a plastic DIP (Dual In-line Package) and the PS2505L-1, -2, -4 are lead bending type (Gull-wing) for surface mount.

FEATURES

- AC input response
- High isolation voltage ($BV = 5\,000\text{ Vr.m.s.}$)
- High collector to emitter voltage ($V_{CEO} = 80\text{ V}$)
- High-speed switching ($t_r = 3\ \mu\text{s TYP.}$, $t_f = 5\ \mu\text{s TYP.}$)
- Ordering number of taping product: PS2505L-1-E3, E4, F3, F4, PS2505L-2-E3, E4
- UL approved: File No. E72422 (S)

APPLICATIONS

- Power supply
- Telephone/FAX.
- FA/OA equipment
- Programmable logic controller

The information in this document is subject to change without notice.

★ PACKAGE DIMENSIONS (in millimeters)

DIP Type

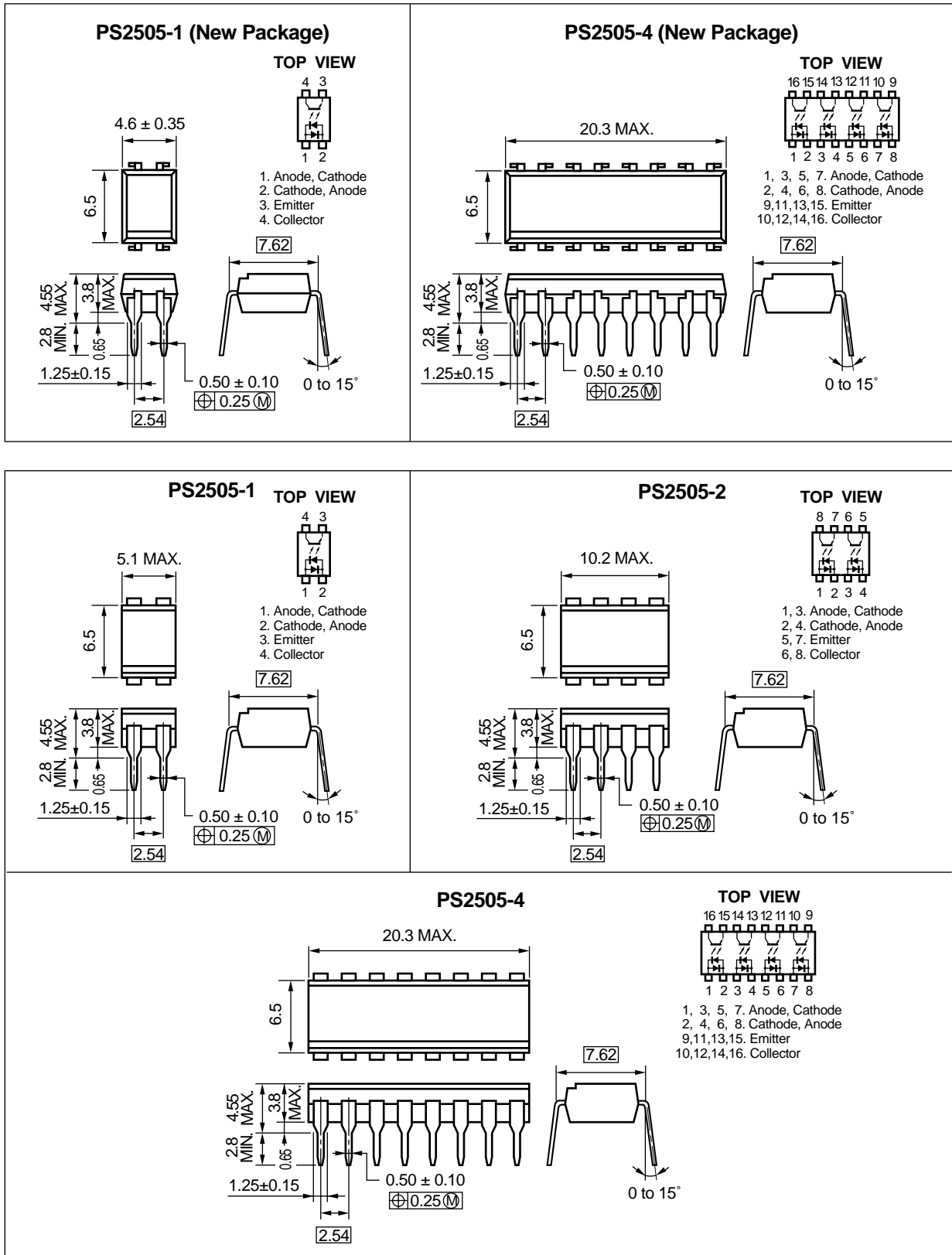

Caution New package 1-ch, 4-ch only

Lead Bending Type

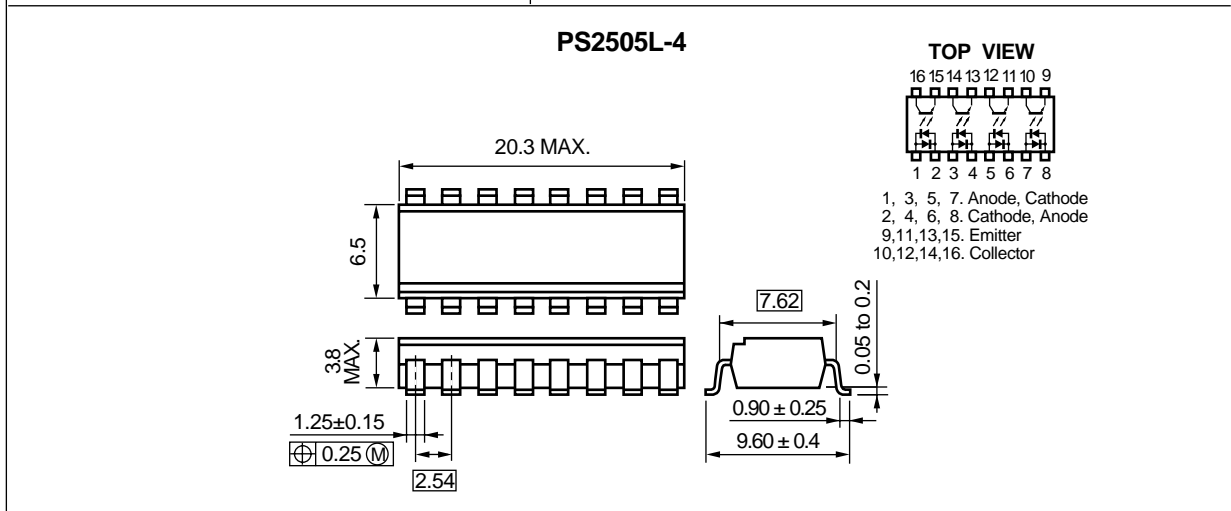
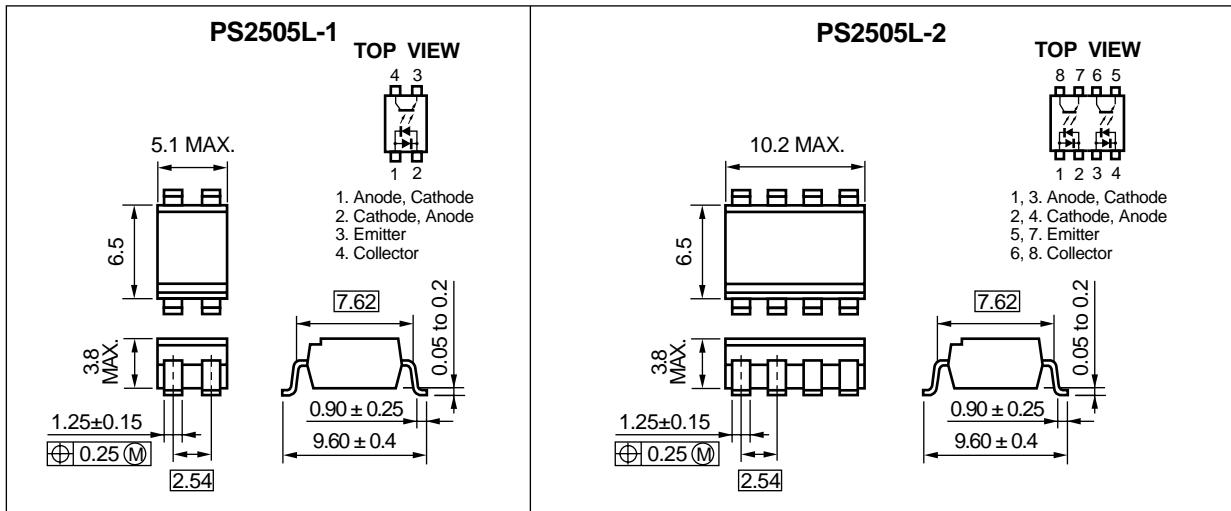
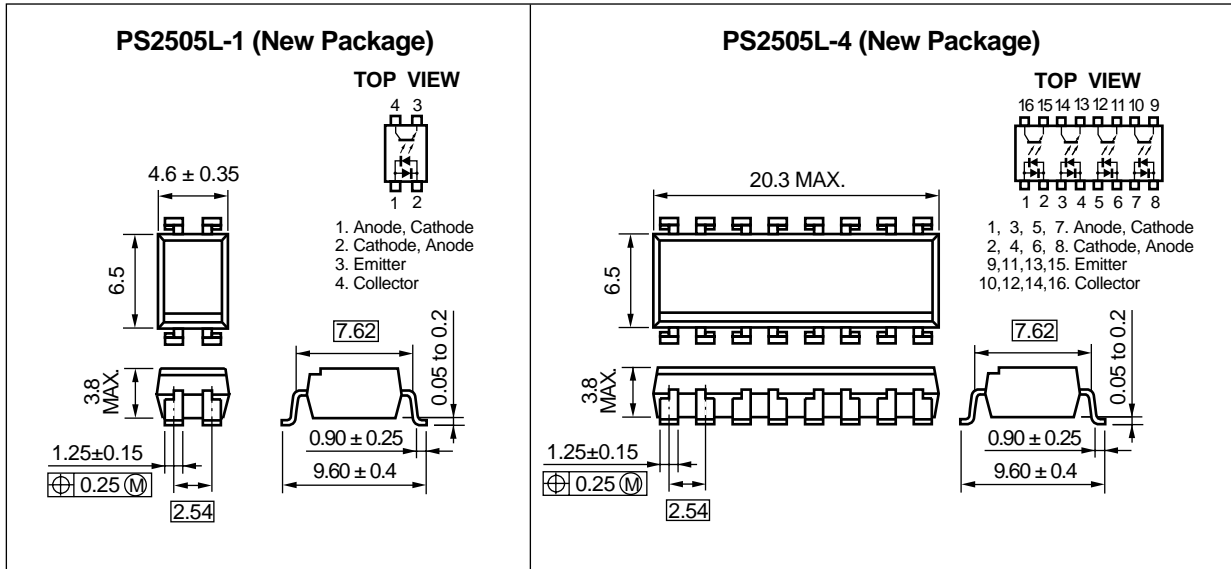

Caution New package 1-ch, 4-ch only

ABSOLUTE MAXIMUM RATINGS (T_A = 25 °C, unless otherwise specified)

Parameter	Symbol	Ratings		Unit	
		PS2505-1, PS2505L-1	PS2505-2,-4 PS2505L-2,-4		
Diode	Forward Current (DC)	I _F	±80		mA
	Power Dissipation Derating	ΔP _D /°C	1.5	1.2	mW/°C
	Power Dissipation	P _D	150	120	mW/ch
	Peak Forward Current ^{*1}	I _{FP}	±1		A
Transistor	Collector to Emitter Voltage	V _{CEO}	80		V
	Emitter to Collector Voltage	V _{ECO}	7		V
	Collector Current	I _C	50		mA/ch
	Power Dissipation Derating	ΔP _C /°C	1.5	1.2	mW/°C
	Power Dissipation	P _C	150	120	mW/ch
Isolation Voltage ^{*2}	BV	5 000		Vr.m.s.	
Operating Ambient Temperature	T _A	-55 to +100		°C	
Storage Temperature	T _{stg}	-55 to +150		°C	

*1 PW = 100 μs, Duty Cycle = 1 %

*2 AC voltage for 1 minute at T_A = 25 °C, RH = 60 % between input and output

ELECTRICAL CHARACTERISTICS (T_A = 25 °C)

Parameter	Symbol	Conditions	MIN.	TYP.	MAX.	Unit		
Diode	Forward Voltage	V _F	I _F = ±10 mA		1.17	1.4	V	
	Terminal Capacitance	C _t	V = 0 V, f = 1.0 MHz		100		pF	
Transistor	Collector to Emitter Dark Current	I _{CEO}	V _{CE} = 80 V, I _F = 0 mA			100	nA	
Coupled	Current Transfer Ratio (I _C /I _F)	CTR	I _F = ±5 mA, V _{CE} = 5 V		80	300	600	%
	CTR Ratio ^{*1}	CTR1/ CTR2	I _F = 5 mA, V _{CE} = 5 V		0.3	1.0	3.0	
	Collector Saturation Voltage	V _{CE(sat)}	I _F = ±10 mA, I _C = 2 mA				0.3	V
	Isolation Resistance	R _{I-o}	V _{I-o} = 1.0 kV _{DC}		10 ¹¹			Ω
	Isolation Capacitance	C _{I-o}	V = 0 V, f = 1.0 MHz			0.5		pF
	Rise Time ^{*2}	t _r	V _{CC} = 10 V, I _C = 2 mA, R _L = 100 Ω			3		μs
	Fall Time ^{*2}	t _f				5		

*1 CTR1 = I_{C1}/I_{F1}, CTR2 = I_{C2}/I_{F2}

*2 Test circuit for switching time

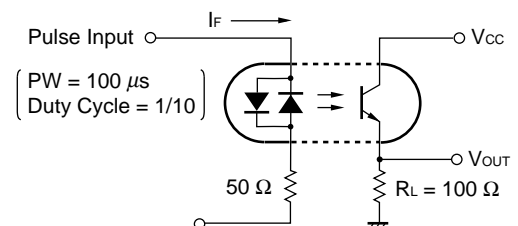
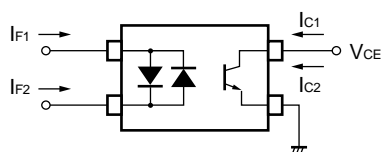

TYPICAL CHARACTERISTICS (T_A = 25 °C, unless otherwise specified)

DIODE POWER DISSIPATION vs. AMBIENT TEMPERATURE

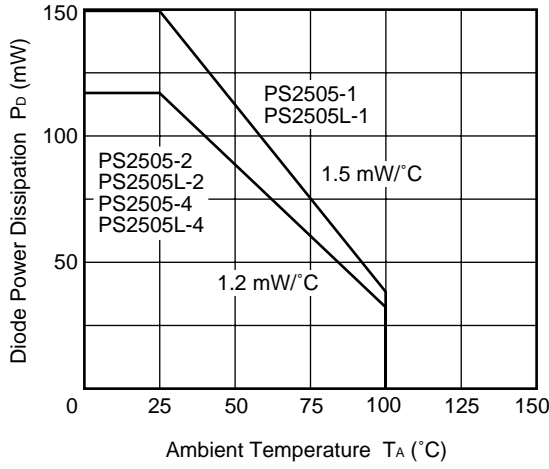

TRANSISTOR POWER DISSIPATION vs. AMBIENT TEMPERATURE

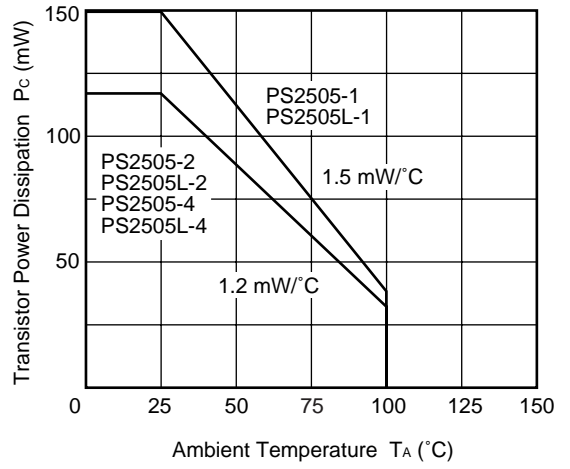

FORWARD CURRENT vs. FORWARD VOLTAGE

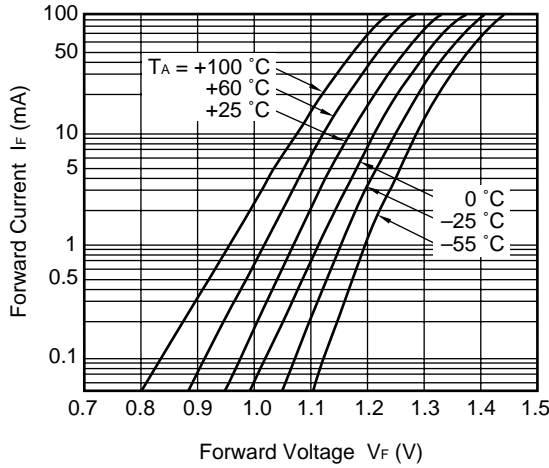

FORWARD CURRENT vs. FORWARD VOLTAGE

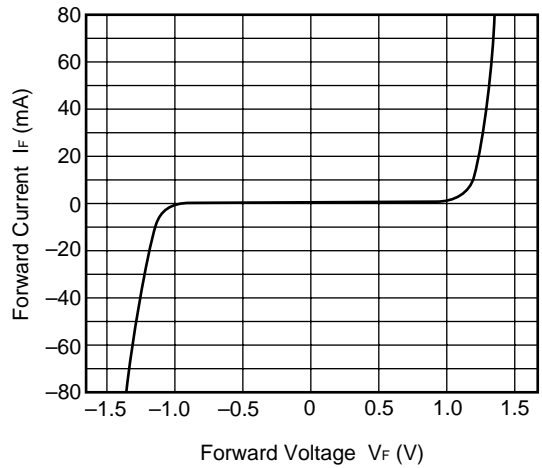

COLLECTOR TO EMITTER DARK CURRENT vs. AMBIENT TEMPERATURE

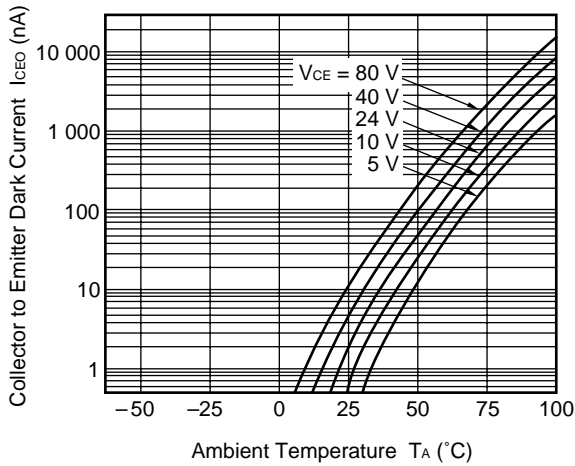

COLLECTOR CURRENT vs. COLLECTOR SATURATION VOLTAGE

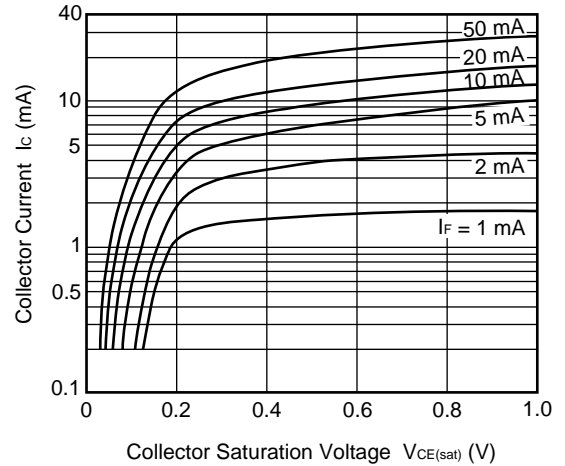

COLLECTOR CURRENT vs. COLLECTOR TO EMITTER VOLTAGE

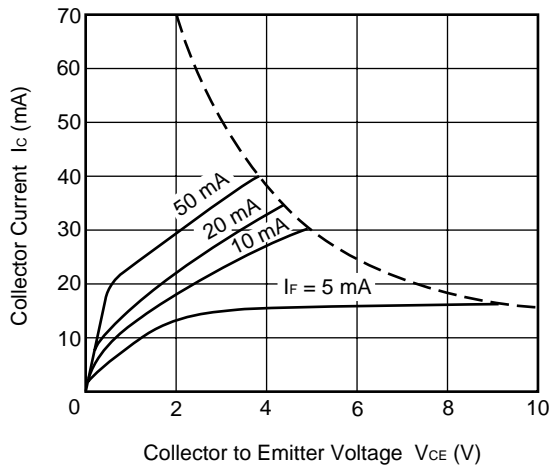

NORMALIZED CURRENT TRANSFER RATIO vs. AMBIENT TEMPERATURE

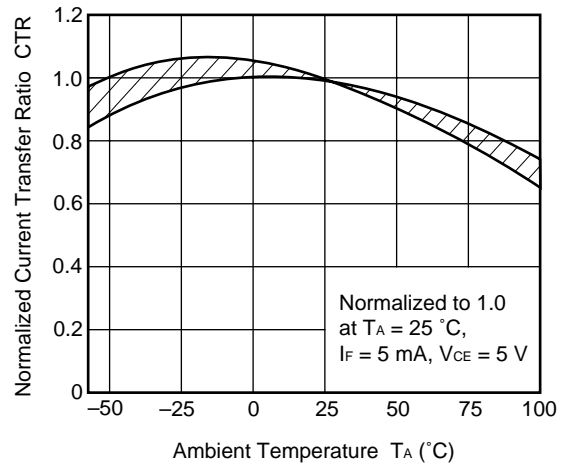

CURRENT TRANSFER RATIO vs. FORWARD CURRENT

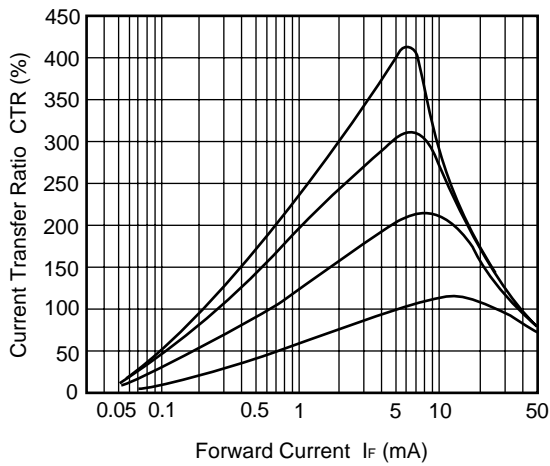

SWITCHING TIME vs. LOAD RESISTANCE

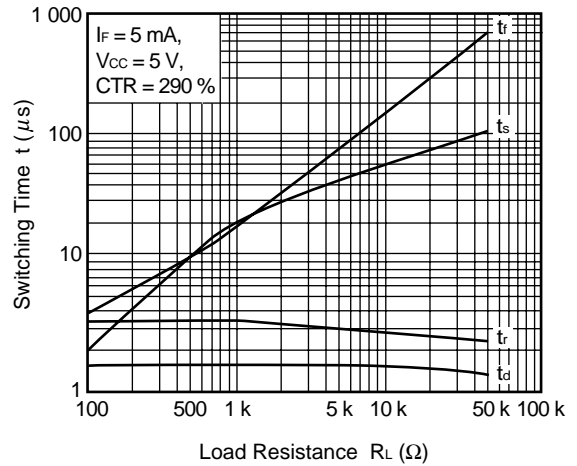

SWITCHING TIME vs. LOAD RESISTANCE

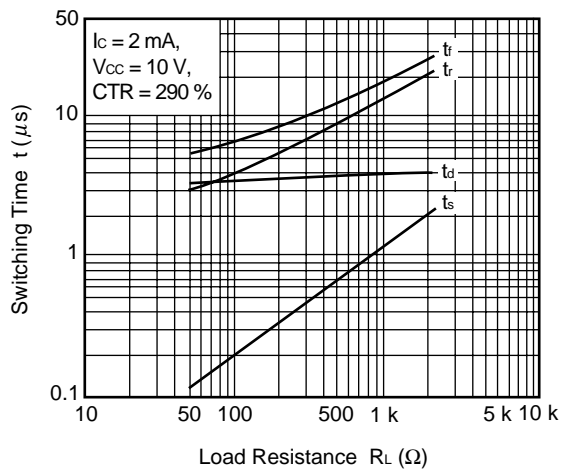

FREQUENCY RESPONSE

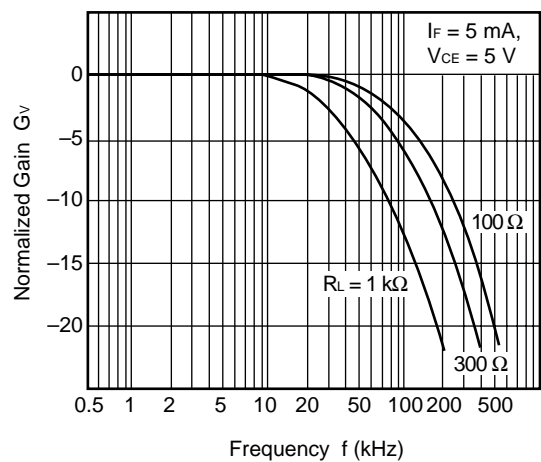

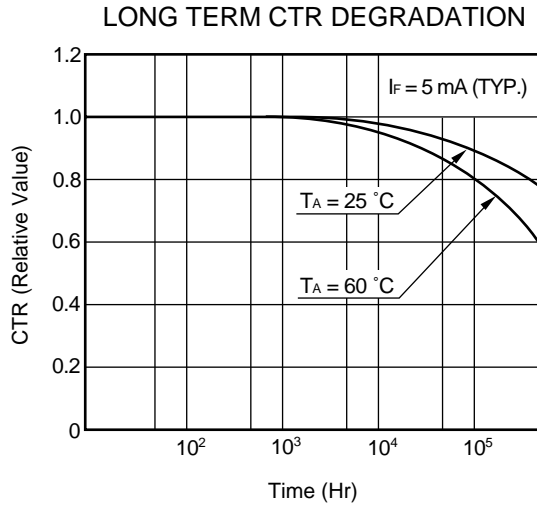

Remark The graphs indicate nominal characteristics.

TAPING SPECIFICATIONS (in millimeters)

Outline and Dimensions (Tape)

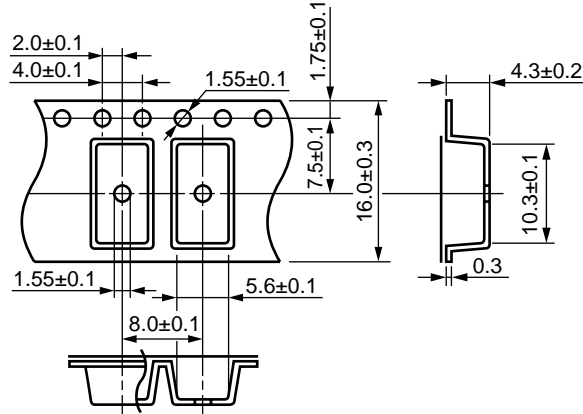

Tape Direction

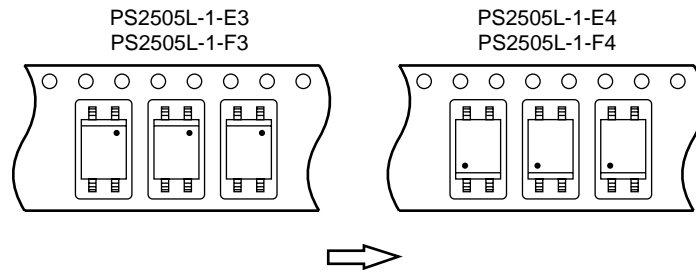

Outline and Dimensions (Reel)

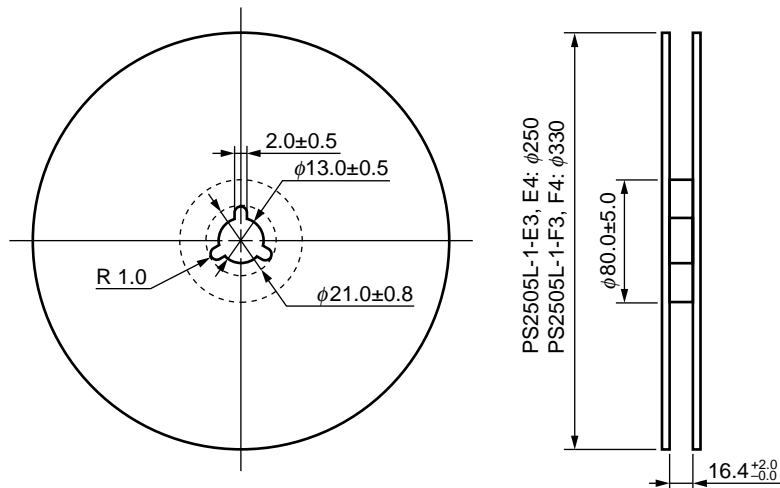

Packing: PS2505L-1-E3, E4 1 000 pcs/reel
 PS2505L-1-F3, F4 2 000 pcs/reel

RECOMMENDED SOLDERING CONDITIONS

(1) Infrared reflow soldering

- Peak reflow temperature 235 °C (package surface temperature)
- Time of temperature higher than 210 °C 30 seconds or less
- Number of reflows Three
- Flux Rosin flux containing small amount of chlorine (The flux with a maximum chlorine content of 0.2 Wt % is recommended.)

Recommended Temperature Profile of Infrared Reflow

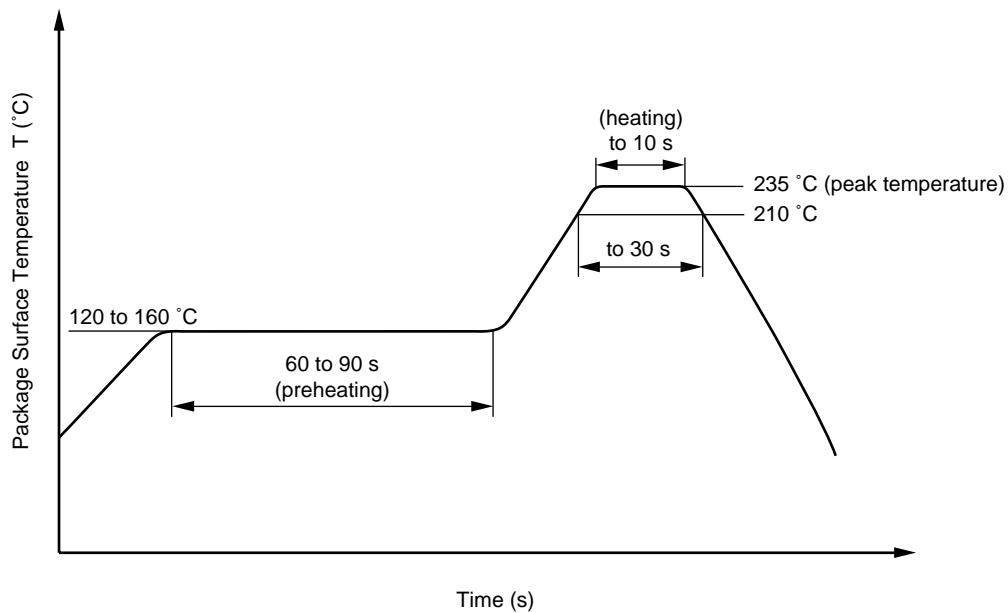

Caution Avoid removing the residual flux with chlorine-based cleaning solvent after a reflow process.

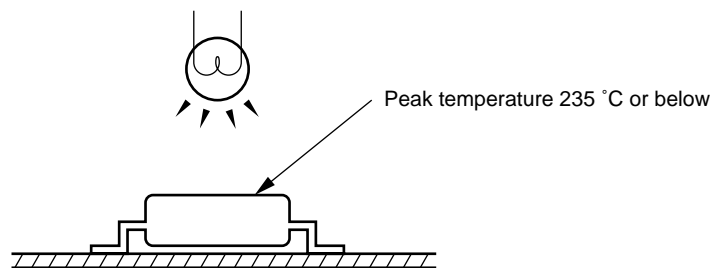

(2) Dip soldering

- Temperature 260 °C or below (molten solder temperature)
- Time 10 seconds or less
- Number of times One
- Flux Rosin flux containing small amount of chlorine (The flux with a maximum chlorine content of 0.2 Wt % is recommended.)

[MEMO]

CAUTION

Within this device there exists GaAs (Gallium Arsenide) material which is a harmful substance if ingested. Please do not under any circumstances break the hermetic seal.

NEPOC is a trademark of NEC Corporation.

No part of this document may be copied or reproduced in any form or by any means without the prior written consent of NEC Corporation. NEC Corporation assumes no responsibility for any errors which may appear in this document.

NEC Corporation does not assume any liability for infringement of patents, copyrights or other intellectual property rights of third parties by or arising from use of a device described herein or any other liability arising from use of such device. No license, either express, implied or otherwise, is granted under any patents, copyrights or other intellectual property rights of NEC Corporation or others.

While NEC Corporation has been making continuous effort to enhance the reliability of its semiconductor devices, the possibility of defects cannot be eliminated entirely. To minimize risks of damage or injury to persons or property arising from a defect in an NEC semiconductor device, customers must incorporate sufficient safety measures in its design, such as redundancy, fire-containment, and anti-failure features.

NEC devices are classified into the following three quality grades:

"Standard", "Special", and "Specific". The Specific quality grade applies only to devices developed based on a customer designated "quality assurance program" for a specific application. The recommended applications of a device depend on its quality grade, as indicated below. Customers must check the quality grade of each device before using it in a particular application.

Standard: Computers, office equipment, communications equipment, test and measurement equipment, audio and visual equipment, home electronic appliances, machine tools, personal electronic equipment and industrial robots

Special: Transportation equipment (automobiles, trains, ships, etc.), traffic control systems, anti-disaster systems, anti-crime systems, safety equipment and medical equipment (not specifically designed for life support)

Specific: Aircrafts, aerospace equipment, submersible repeaters, nuclear reactor control systems, life support systems or medical equipment for life support, etc.

The quality grade of NEC devices is "Standard" unless otherwise specified in NEC's Data Sheets or Data Books. If customers intend to use NEC devices for applications other than those specified for Standard quality grade, they should contact an NEC sales representative in advance.

Anti-radioactive design is not implemented in this product.