



## CARDBUS POWER-INTERFACE SWITCHES FOR SERIAL PCMCIA CONTROLLERS

### FEATURES

- **Single-Slot Switch: TPS2220A**  
**Dual-Slot Switches: TPS2223A, TPS2224A, TPS2226A**
- **Fast Current Limit Response Time**
- **Fully Integrated VCC and VPP Switching for 3.3 V, 5 V, and 12 V (no 12 V on TPS2223A)**
- **Meets Current PC Card™ Standards**
- **V<sub>pp</sub> Output Selection Independent of V<sub>CC</sub>**
- **12-V and 5-V Supplies Can Be Disabled**
- **TTL-Logic Compatible Inputs**
- **Short-Circuit and Thermal Protection**
- **24-Pin HTSSOP, 24- or 30-Pin SSOP**
- **140-μA (Typical) Quiescent Current from 3.3-V Input**
- **Break-Before-Make Switching**
- **Power-On Reset**
- **40°C to 85°C Operating Ambient Temperature Range**

### APPLICATIONS

- **Notebook and Desktop Computers**
- **Bar Code Scanners**
- **Digital Cameras**
- **Set-Top Boxes**
- **PDA's**

**TPS2223A, TPS2224A  
DB OR PWP PACKAGE  
(TOP VIEW)**

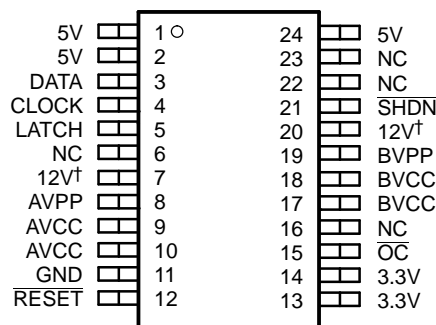

NC – No internal connection  
† Pin 7 and 20 are NC for TPS2223A.

### DESCRIPTION

The TPS2223A, TPS2224A, and TPS2226A CardBus™ power-interface switches provide an integrated power-management solution for two PC Card sockets. The TPS2220A is a single-slot option for this family of devices. These devices allow the controlled distribution of 3.3 V, 5 V, and 12 V to each card slot. The current-limiting and thermal-protection features eliminate the need for fuses. Current-limit reporting helps the user isolate a system fault. The switch  $r_{DS(on)}$  and current-limit values have been set for the peak and average current requirements stated in the PC Card specification, and optimized for cost. A faster maximum current limit response time is the only difference between the TPS2223A, TPS2224A, and TPS2226A and the TPS2223, TPS2224, and TPS2226.

Like the TPS2214 and TPS2214A and the TPS2216 and TPS2216A, this family of devices supports independent VPP/VCC switching; however, the standby and interface-mode pins are not supported. Shutdown mode is now supported independently on  $\overline{SHDN}$  as well as in the serial interface. Optimized for lower power implementation, the TPS2223A does not support 12-V switching to VPP. See the available options table for pin-compatible device information.



Please be aware that an important notice concerning availability, standard warranty, and use in critical applications of Texas Instruments semiconductor products and disclaimers thereto appears at the end of this data sheet.

PC Card, CardBus are trademarks of PCMCIA (Personal Computer Memory Card International Association).  
PowerPAD is a trademark of Texas Instruments.



These devices have limited built-in ESD protection. The leads should be shorted together or the device placed in conductive foam during storage or handling to prevent electrostatic damage to the MOS gates.

### AVAILABLE OPTIONS

T <sub>A</sub>	PACKAGED DEVICES							
	PLASTIC SMALL OUTLINE					PowerPAD™ PLASTIC SMALL OUTLINE (PWP-24) <sup>(1)</sup>		
	DB-24		DB-30					
-40°C to 85°C	TPS2223ADB, TPS2224ADB		TPS2220ADB	TPS2226ADB			TPS2223APWP, TPS2224APWP	TPS2220APWP
	Pin compatibles	TPS2214, TPS2214A		Pin compatibles	TPS2216, TPS2216A, TPS2206			

(1) The DB and PWP packages are also available taped and reeled. Add R suffix to device type (e.g., TPS2223APWPR) for taped and reeled.

### LEAD (PB-FREE) ORDERING INFORMATION

T <sub>A</sub>	SSOP(DB)	STATUS <sup>(1)</sup>	HTSSOP(PWP)	STATUS <sup>(1)</sup>	ECO-STATUS <sup>(2)</sup>
-40°C to 85°C	TPS2220ADBG4	Active	TPS2220APWPRG4	Active	Green
	TPS2223ADBG4	Active	TPS2223APWPRG4	Preview	
	TPS2224ADBG4	Active	TPS2224APWPRG4	Preview	
	TPS2226ADBG4	Active	TPS2226APWPRG4	Preview	

(1) The marketing status values are defined as follows:

- **ACTIVE:** This device recommended for new designs.
- **LIFEBUY:** TI has announced that the device will be discontinued, and a lifetime-buy period is in effect.
- **NRND:** Not recommended for new designs. Device is in production to support existing customers, but TI does not recommend using this part in a new design.
- **PREVIEW:** Device has been announced but is not in production. Samples may or may not be available.
- **OBSOLETE:** TI has discontinued production of the device.

(2) **Eco-Status Information** – Additional details including specific material content can be accessed at [www.ti.com/leadfree](http://www.ti.com/leadfree)

- **N/A:** Not yet available Lead (Pb)-free, for estimated conversion dates go to [www.ti.com/leadfree](http://www.ti.com/leadfree).
- **Pb-Free:** TI defines "Lead (Pb)-Free" or "Pb-Free" to mean RoHS compatible, including a lead concentration that does not exceed 0.1% of total product weight, and, if designed to be soldered, suitable for use in specified lead-free soldering processes.
- **Green:** TI devices "Green" to mean Lead (Pb)-Free and in addition, uses package materials that do not contain halogens, including bromine (Br), or antimony (Sb) above 0.1% of total product weight.

## ABSOLUTE MAXIMUM RATINGS

over operating free-air temperature range (unless otherwise noted)<sup>(1)</sup>

		TPA222xA	UNIT	
V <sub>I</sub>	Input voltage range for card power	V <sub>I(3.3V)</sub>	–0.3 to 5.5	V
		V <sub>I(5V)</sub>	–0.3 to 5.5	V
		V <sub>I(12V)</sub> <sup>(2)</sup>	–0.3 to 14	V
Logic input/output voltage		–0.3 to 6	V	
V <sub>O</sub>	Output voltage	V <sub>O(xVCC)</sub>	–0.3 to 6	V
		V <sub>O(xVPP)</sub>	–0.3 to 14	V
Continuous total power dissipation		See Dissipation Rating Table		
I <sub>O</sub>	Output current	I <sub>O(xVCC)</sub>	Internally Limited	
		I <sub>O(xVPP)</sub>	Internally Limited	
T <sub>J</sub>	Operating virtual junction temperature range	–40 to 100	°C	
T <sub>stg</sub>	Storage temperature range	–55 to 150	°C	
Lead temperature 1,6 mm (1/16 inch) from case for 10 seconds)		260	°C	
$\overline{OC}$ sink current		10	mA	

- (1) Stresses beyond those listed under "absolute maximum ratings" may cause permanent damage to the device. These are stress ratings only, and functional operation of the device at these or any other conditions beyond those indicated under "recommended operating conditions" is not implied. Exposure to absolute-maximum-rated conditions for extended periods may affect device reliability.
- (2) Not applicable for TPS2223A

## DISSIPATION RATING TABLE

PACKAGE <sup>(1)</sup>		T <sub>A</sub> ≤ 25°C POWER RATING	DERATING FACTOR ABOVE T <sub>A</sub> = 25°C	T <sub>A</sub> = 70°C POWER RATING	T <sub>A</sub> = 85°C POWER RATING
DB	24	890 mW	8.9 mW/°C	489 mW	356 mW
	30	1095 mW	10.95 mW/°C	602 mW	438 mW
PWP	24	3322 mW	33.22 mW/°C	1827 mW	1329 mW

- (1) These devices are mounted on an JEDEC low-k board (2-oz. traces on surface).

## RECOMMENDED OPERATING CONDITIONS

		MIN	MAX	UNIT	
Input voltage, V <sub>I(3.3V)</sub> is required for all circuit operations. 5V and 12V are only required for their respective functions.	V <sub>I(3.3V)</sub> <sup>(1)</sup>	3	3.6	V	
	V <sub>I(5V)</sub>	3	5.5		
	V <sub>I(12V)</sub> <sup>(2)</sup>	7	13.5		
I <sub>O</sub>	Output current	I <sub>O(xVCC)</sub> at T <sub>J</sub> = 100°C		1	A
		I <sub>O(xVPP)</sub> at T <sub>J</sub> = 100°C		100	mA
f <sub>(clock)</sub>	Clock frequency			2.5	MHz
t <sub>w</sub>	Pulse duration	Data	200		ns
		Latch	250		
		Clock	100		
		Reset	100		
t <sub>h</sub>	Data-to-clock hold time (see Figure 2)	100		ns	
t <sub>su</sub>	Data-to-clock setup time (see Figure 2)	100		ns	
t <sub>d(latch)</sub>	Latch delay time (see Figure 2)	100		ns	
t <sub>d(clock)</sub>	Clock delay time (see Figure 2)	250		ns	
T <sub>J</sub>	Operating virtual junction temperature (maximum to be calculated at worst case P <sub>D</sub> at 85°C ambient)	–40	100	°C	

- (1) It is understood that for V<sub>I(3.3V)</sub> < 3 V, voltages within the absolute maximum ratings applied to pin 5V or pin 12V do not damage the IC.
- (2) Not applicable for TPS2223A

## ELECTRICAL CHARACTERISTICS

$T_J = 25^\circ\text{C}$ ,  $V_{I(5V)} = 5\text{ V}$ ,  $V_{I(3.3V)} = 3.3\text{ V}$ ,  $V_{I(12V)} = 12\text{ V}$  (not applicable for TPS2223A), all outputs unloaded (unless otherwise noted)

PARAMETER		TEST CONDITIONS <sup>(1)</sup>		MIN	TYP	MAX	UNIT		
<b>POWER SWITCH</b>									
$r_{DS(on)}$	Static drain-source on-state resistance	3.3V to xVCC <sup>(2)</sup>	$I_O = 750\text{ mA}$ each		85	110	m $\Omega$		
			$I_O = 750\text{ mA}$ each, $T_J = 100^\circ\text{C}$		110	140			
	5V to xVCC <sup>(2)</sup>	$I_O = 500\text{ mA}$ each		95	130	$\Omega$			
		$I_O = 500\text{ mA}$ each, $T_J = 100^\circ\text{C}$		120	160				
	3.3V or 5V to xVPP <sup>(2)</sup>	$I_O = 50\text{ mA}$ each		0.8	1				
		$I_O = 50\text{ mA}$ each, $T_J = 100^\circ\text{C}$		1	1.3				
12V to xVPP <sup>(2)</sup>	$I_O = 50\text{ mA}$ each		2	2.5					
	$I_O = 50\text{ mA}$ each, $T_J = 100^\circ\text{C}$		2.5	3.4					
Output discharge resistance	Discharge at xVCC	$I_{O(disco)} = 1\text{ mA}$		0.5	0.7	1	k $\Omega$		
	Discharge at xVPP	$I_{O(disco)} = 1\text{ mA}$		0.2	0.4	0.5			
$I_{OS}$	Short-circuit output current	Limit (steady-state value), output powered into a short circuit	$I_{OS(xVCC)}$		1	1.4	2	A	
			$I_{OS(xVPP)}$		120	200	300	mA	
		Limit (steady-state value), output powered into a short circuit, $T_J = 100^\circ\text{C}$	$I_{OS(xVCC)}$		1	1.4	2	A	
			$I_{OS(xVPP)}$		120	200	300	mA	
$T_J$	Thermal shutdown temperature <sup>(2)</sup>	Thermal trip point	Rising temperature		135		$^\circ\text{C}$		
		Hysteresis			10				
Current-limit response time <sup>(3)(4)</sup>		5V to xVCC = 5 V, with 100-m $\Omega$ short to GND			10		$\mu\text{s}$		
		5V to xVPP = 5 V, with 100-m $\Omega$ short to GND			3				
$I_I$	Normal operation	$I_{I(3.3V)}$	$V_O(xVCC) = V_O(xVPP) = 3.3\text{ V}$ and also for RESET = 0 V		140	200	$\mu\text{A}$		
				$I_{I(5V)}$		8		12	
				$I_{I(12V)}$		100		180	
	Shutdown mode	$I_{I(3.3V)}$		$V_O(xVCC) = V_O(xVPP) = \text{Hi-z}$		0.3		2	
					$I_{I(5V)}$			0.1	2
					$I_{I(12V)}$			0.3	2
$I_{lkg}$	Leakage current, output off state	Shutdown mode	$V_O(xVCC) = 5\text{ V}$ , $V_{I(5V)} = V_{I(12V)} = 0\text{ V}$			10		$\mu\text{A}$	
					$T_J = 100^\circ\text{C}$		50		
			$V_O(xVPP) = 12\text{ V}$ , $V_{I(5V)} = V_{I(12V)} = 0\text{ V}$			10			
				$T_J = 100^\circ\text{C}$		50			

- (1) Pulse-testing techniques maintain junction temperature close to ambient temperature; thermal effects must be taken into account separately.
- (2) TPS2223A, TPS2224A, TPS2226A: two switches on. TPS2220A: one switch on.
- (3) Specified by design; not tested in production.
- (4) From application of short to 110% of final current limit.

PARAMETER		TEST CONDITIONS <sup>(1)</sup>	MIN	TYP	MAX	UNIT	
<b>LOGIC SECTION (CLOCK, DATA, LATCH, RESET, SHDN, OC)</b>							
$I_i$	Input current, logic	$I_{i(\text{RESET})}$ <sup>(5)</sup>	RESET = 5.5 V		-1	1	$\mu\text{A}$
			RESET = 0 V		-30	-20	
	$I_{i(\text{SHDN})}$ <sup>(5)</sup>	SHDN = 5.5 V		-1	1		
		SHDN = 0 V		-50	-3		
	$I_{i(\text{LATCH})}$ <sup>(5)</sup>	LATCH = 5.5 V					
LATCH = 0 V		-1	1				
$I_{i(\text{CLOCK, DATA})}$	0 V to 5.5 V		-1	1			
$V_{IH}$	High-level input voltage, logic		2			V	
$V_{IL}$	Low-level input voltage, logic				0.8	V	
$V_{O(\text{sat})}$	Output saturation voltage at $\overline{\text{OC}}$	$I_o = 2 \text{ mA}$		0.14	0.4	V	
$I_{ikg}$	Leakage current at $\overline{\text{OC}}$	$V_{O(\text{OC})} = 5.5 \text{ V}$		0	1	$\mu\text{A}$	
<b>UVLO AND POR (POWER-ON RESET)</b>							
$V_{I(3.3V)}$	Input voltage at 3.3V pin, UVLO	3.3-V level below which all switches are Hi-Z	2.4	2.7	2.9	V	
$V_{hys(3.3V)}$	UVLO hysteresis voltage at VA <sup>(6)</sup>			100		mV	
$V_{I(5V)}$	Input voltage at 5V pin, UVLO	5-V level below which only 5V switches are Hi-Z	2.3	2.5		V	
$V_{hys(5V)}$	UVLO hysteresis voltage at 5V <sup>(6)</sup>	Delay from voltage hit (step from 3 V to 2.3 V) to Hi-Z control (90% $V_G$ to GND)		100		mV	
$t_{df}$	Delay time for falling response, UVLO <sup>(6)</sup>			4		$\mu\text{s}$	
$V_{I(\text{POR})}$	Input voltage, power-on reset <sup>(6)</sup>	3.3-V voltage below which POR is asserted causing a RESET internally with all line switches open and all discharge switches closed.			1.7	V	

(5) LATCH has low-current pulldown. RESET and SHDN have low-current pullup.

(6) Specified by design; not tested in production.

## SWITCHING CHARACTERISTICS

$V_{CC} = 5\text{ V}$ ,  $T_A = 25^\circ\text{C}$ ,  $V_{I(3.3V)} = 3.3\text{ V}$ ,  $V_{I(5V)} = 5\text{ V}$ ,  $V_{I(12V)} = 12\text{ V}$  (not applicable for TPS2223A) all outputs unloaded (unless otherwise noted)

PARAMETER <sup>(1)</sup>	LOAD CONDITION	TEST CONDITIONS <sup>(2)</sup>	MIN	TYP	MAX	UNIT
$t_r$ Output rise times <sup>(3)</sup>	$C_{L(xVCC)} = 0.1\ \mu\text{F}$ , $C_{L(xVPP)} = 0.1\ \mu\text{F}$ , $I_{O(xVCC)} = 0\ \text{A}$ , $I_{O(xVPP)} = 0\ \text{A}$	$V_{O(xVCC)} = 5\ \text{V}$		0.9		ms
		$V_{O(xVPP)} = 12\ \text{V}$		0.26		
	$C_{L(xVCC)} = 150\ \mu\text{F}$ , $C_{L(xVPP)} = 10\ \mu\text{F}$ , $I_{O(xVCC)} = 0.75\ \text{A}$ , $I_{O(xVPP)} = 50\ \text{mA}$	$V_{O(xVCC)} = 5\ \text{V}$		1.1		
		$V_{O(xVPP)} = 12\ \text{V}$		0.6		
$t_f$ Output fall times <sup>(3)</sup>	$C_{L(xVCC)} = 0.1\ \mu\text{F}$ , $C_{L(xVPP)} = 0.1\ \mu\text{F}$ , $I_{O(xVCC)} = 0\ \text{A}$ , $I_{O(xVPP)} = 0\ \text{A}$	$V_{O(xVCC)} = 5\ \text{V}$ , Discharge switches ON		0.5		ms
		$V_{O(xVPP)} = 12\ \text{V}$ , Discharge switches ON		0.2		
	$C_{L(xVCC)} = 150\ \mu\text{F}$ , $C_{L(xVPP)} = 10\ \mu\text{F}$ , $I_{O(xVCC)} = 0.75\ \text{A}$ , $I_{O(xVPP)} = 50\ \text{mA}$	$V_{O(xVCC)} = 5\ \text{V}$		2.35		
		$V_{O(xVPP)} = 12\ \text{V}$		3.9		
$t_{pd}$ Propagation delay times <sup>(3)</sup>	$C_{L(xVCC)} = 0.1\ \mu\text{F}$ , $C_{L(xVPP)} = 0.1\ \mu\text{F}$ , $I_{O(xVCC)} = 0\ \text{A}$ , $I_{O(xVPP)} = 0\ \text{A}$	Latch $\uparrow$ to xVPP (12V) <sup>(4)</sup>	$t_{pdon}$		2	ms
			$t_{pdoff}$		0.62	
		Latch $\uparrow$ to xVPP (5V)	$t_{pdon}$		0.77	
			$t_{pdoff}$		0.51	
		Latch $\uparrow$ to xVPP (3.3V)	$t_{pdon}$		0.75	
			$t_{pdoff}$		0.52	
		Latch $\uparrow$ to xVCC (5V)	$t_{pdon}$		0.3	
			$t_{pdoff}$		2.5	
		Latch $\uparrow$ to xVCC (3.3V)	$t_{pdon}$		0.3	
			$t_{pdoff}$		2.8	
	$C_{L(xVCC)} = 150\ \mu\text{F}$ , $C_{L(xVPP)} = 10\ \mu\text{F}$ , $I_{O(xVCC)} = 0.75\ \text{A}$ , $I_{O(xVPP)} = 50\ \text{mA}$	Latch $\uparrow$ to xVPP (12V) <sup>(4)</sup>	$t_{pdon}$		2.2	ms
			$t_{pdoff}$		0.8	
		Latch $\uparrow$ to xVPP (5V)	$t_{pdon}$		0.8	
			$t_{pdoff}$		0.6	
Latch $\uparrow$ to xVPP (3.3V)		$t_{pdon}$		0.8		
		$t_{pdoff}$		0.6		
Latch $\uparrow$ to xVCC (5V)	$t_{pdon}$		0.6			
	$t_{pdoff}$		2.5			
Latch $\uparrow$ to xVCC (3.3V)	$t_{pdon}$		0.5			
	$t_{pdoff}$		2.6			

- (1) Refer to Parameter Measurement Information in Figure 1.
- (2) No card inserted, assumes a 0.1- $\mu\text{F}$  output capacitor (see Figure 1).
- (3) Specified by design; not tested in production.
- (4) Not applicable for TPS2223A

**FUNCTIONAL BLOCK DIAGRAM OF TPS2223A, TPS2224A and TPS2226A (see Note A)**

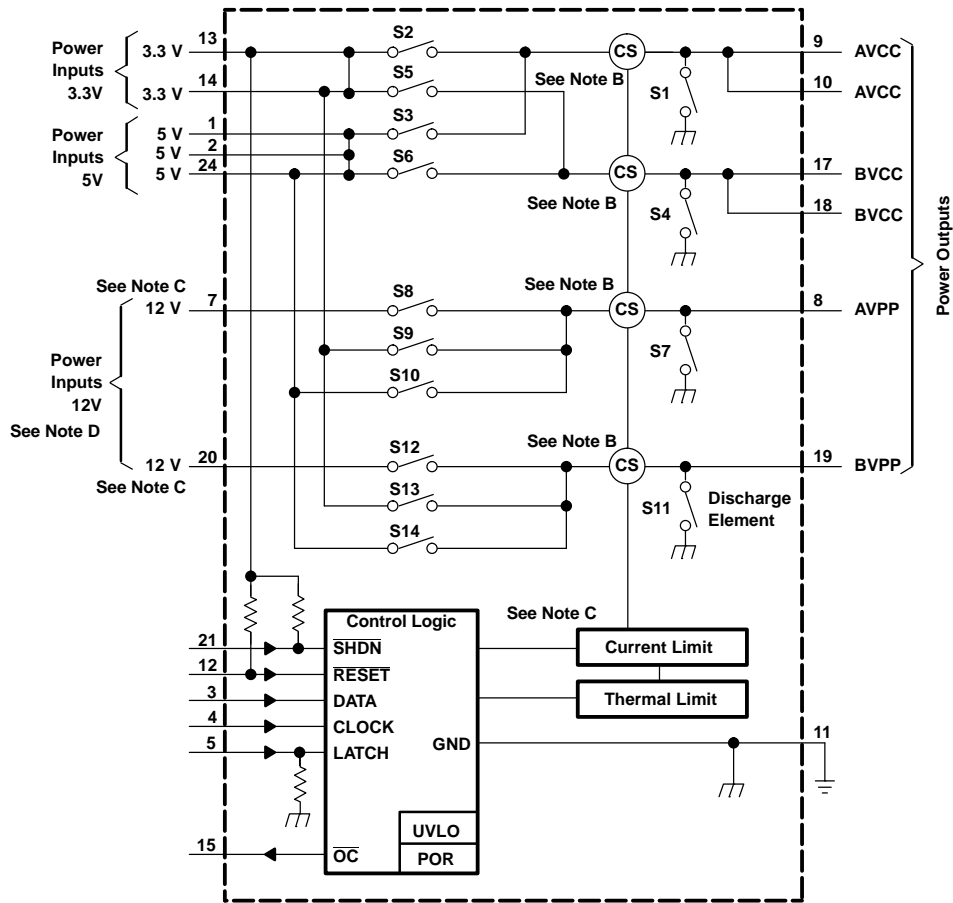

- NOTES: A. Diagram shown for 24-pin DB package.  
 B. Current sense  
 C. The two 12-V pins must be externally connected.  
 D. No connections for TPS2223A.

FUNCTIONAL BLOCK DIAGRAM OF TPS2220A

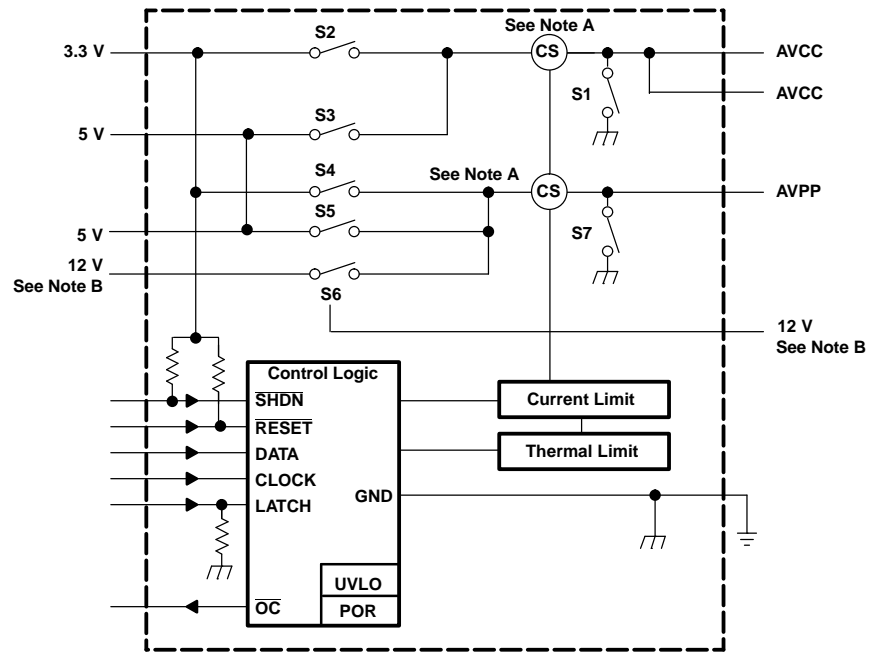

NOTES: A. Current sense  
 B. The two 12-V pins must be externally connected.

PIN ASSIGNMENTS

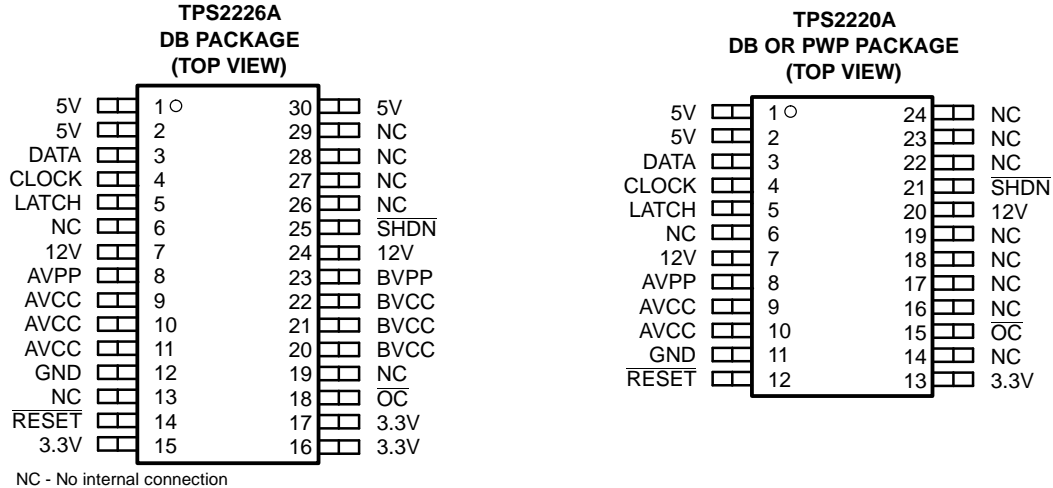



**Terminal Functions**

NAME	TERMINAL NO.				I/O	DESCRIPTION
	TPS2220A	TPS2223A	TPS2224A	TPS2226A		
3.3V	13	13, 14	13, 14	15, 16, 17	I	3.3-V input for card power and chip power
5V	1, 2	1, 2, 24	1, 2, 24	1, 2, 30	I	5-V input for card power
12V	7, 20	NA	7, 20	7, 24	I	12-V input for card power (xVPP). The two 12-V pins must be externally connected.
AVCC	9, 10	9, 10	9, 10	9, 10, 11	O	Switched output that delivers 3.3 V, 5 V, ground or high impedance to card
AVPP	8	8	8	8	O	Switched output that delivers 3.3 V, 5 V, 12 V, ground or high impedance to card (12 V not applicable to TPS2223A)
BVCC	--	17, 18	17, 18	20, 21, 22	O	Switched output that delivers 3.3 V, 5 V, ground or high impedance to card
BVPP	--	19	19	23	O	Switched output that delivers 3.3 V, 5 V, 12 V, ground or high impedance to card (12 V not applicable for TPS2223A)
GND	11	11	11	12		Ground
$\overline{OC}$	15	15	15	18	O	Open-drain overcurrent reporting output that goes low when an overcurrent condition exists. An external pullup is required.
$\overline{SHDN}$	21	21	21	25	I	Hi-Z (open) all switches. Identical function to serial D8. Asynchronous active-low command, internal pullup
$\overline{RESET}$	12	12	12	14	I	Logic-level RESET input active low. Asynchronous active-low command, internal pullup
CLOCK	4	4	4	4	I	Logic-level clock for serial data word
DATA	3	3	3	3	I	Logic-level serial data word
LATCH	5	5	5	5	I	Logic-level latch for serial data word, internal pulldown
NC	6, 14, 16, 17, 18, 19, 22, 23, 24	6, 7, 16, 20, 22, 23	6, 16, 22, 23	6, 13, 19, 26, 27, 28, 29		No internal connection

PARAMETER MEASUREMENT INFORMATION

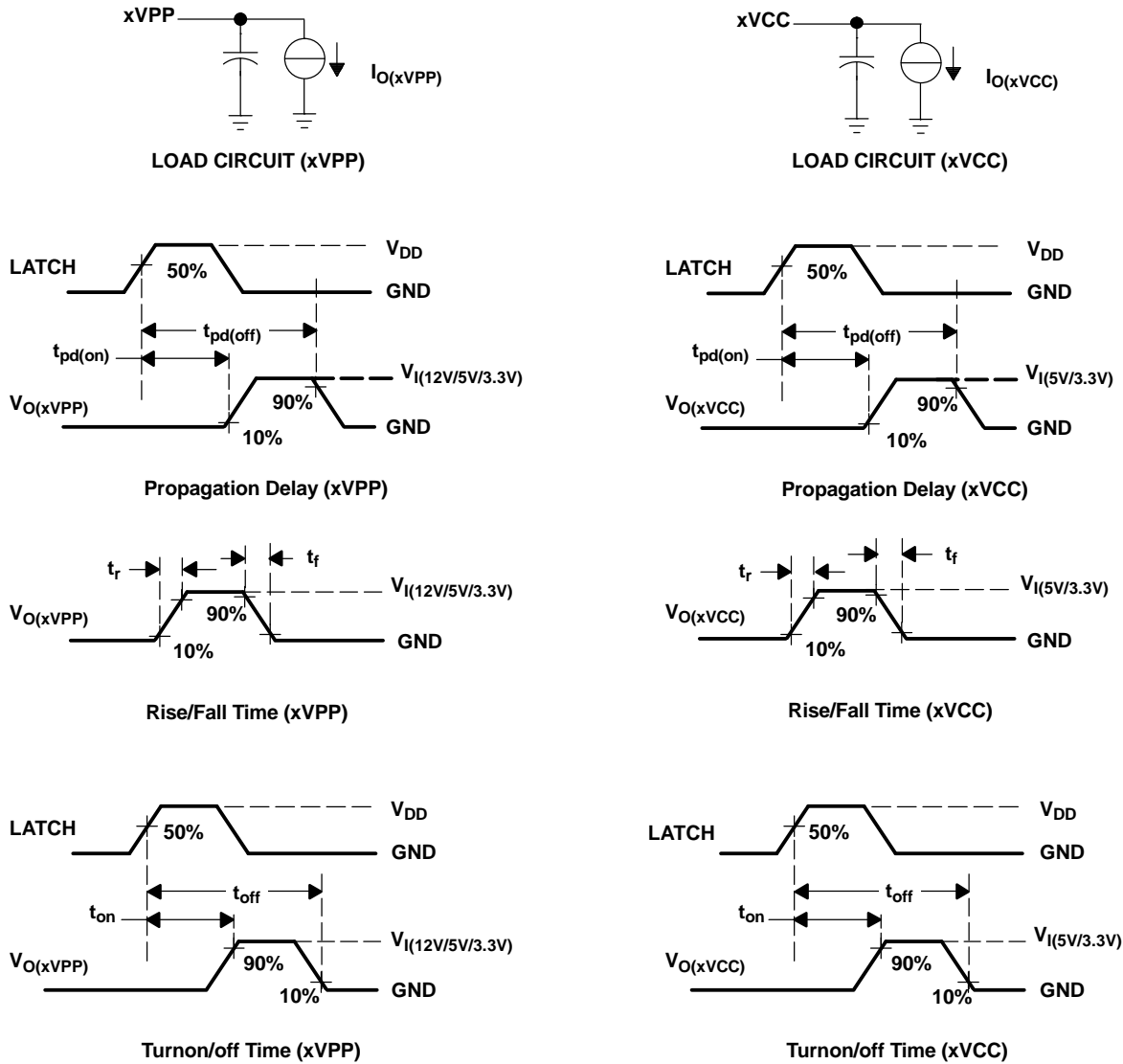

VOLTAGE WAVEFORMS

Figure 1. Test Circuits and Voltage Waveforms

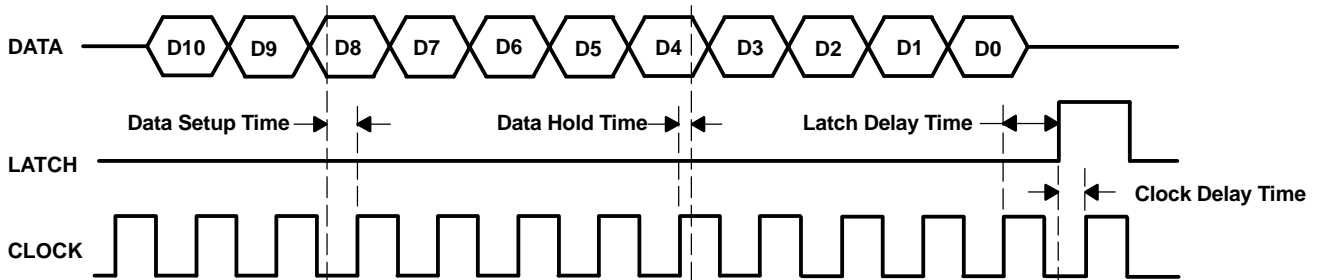

NOTE: Data is clocked in on the positive edge of the clock. The positive edge of the latch signal should occur before the next positive edge of the clock. For definition of D0 to D10, see the control logic table.

Figure 2. Serial-Interface Timing for TPS2226A

## PARAMETER MEASUREMENT INFORMATION (continued)

### Table of Graphs

		FIGURE
Short-circuit response, short applied to powered-on 5-V xVCC-switch output	vs Time	3
Short-circuit response, short applied to powered-on 12-V xVPP-switch output	vs Time	4
$\overline{OC}$ response with ramped overcurrent-limit load on 5-V xVCC-switch output	vs Time	5
$\overline{OC}$ response with ramped overcurrent-limit load on 12-V xVPP-switch output	vs Time	6
xVCC Turnon propagation delay time ( $C_L = 150 \mu\text{F}$ )	vs Junction temperature	7
xVCC Turnoff propagation delay time ( $C_L = 150 \mu\text{F}$ )	vs Junction temperature	8
xVPP Turnon propagation delay time ( $C_L = 10 \mu\text{F}$ )	vs Junction temperature	9
xVPP Turnoff propagation delay time ( $C_L = 10 \mu\text{F}$ )	vs Junction temperature	10
xVCC Turnon propagation delay time ( $T_J = 25^\circ\text{C}$ )	vs Load capacitance	11
xVCC Turnoff propagation delay time ( $T_J = 25^\circ\text{C}$ )	vs Load capacitance	12
xVPP Turnon propagation delay time ( $T_J = 25^\circ\text{C}$ )	vs Load capacitance	13
xVPP Turnoff propagation delay time ( $T_J = 25^\circ\text{C}$ )	vs Load capacitance	14
xVCC Rise time ( $C_L = 150 \mu\text{F}$ )	vs Junction temperature	15
xVCC Fall time ( $C_L = 150 \mu\text{F}$ )	vs Junction temperature	16
xVPP Rise time ( $C_L = 10 \mu\text{F}$ )	vs Junction temperature	17
xVPP Fall time ( $C_L = 10 \mu\text{F}$ )	vs Junction temperature	18
xVCC Rise time ( $T_J = 25^\circ\text{C}$ )	vs Load capacitance	19
xVCC Fall time ( $T_J = 25^\circ\text{C}$ )	vs Load capacitance	20
xVPP Rise time ( $T_J = 25^\circ\text{C}$ )	vs Load capacitance	21
xVPP Fall time ( $T_J = 25^\circ\text{C}$ )	vs Load capacitance	22

SHORT-CIRCUIT RESPONSE,  
 SHORT APPLIED TO POWERED-ON 5-V  
 xVCC-SWITCH OUTPUT

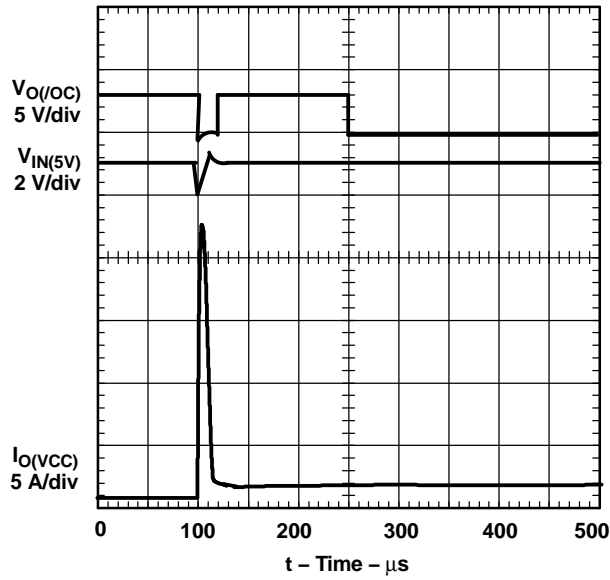

Figure 3.

SHORT-CIRCUIT RESPONSE,  
 SHORT APPLIED TO POWERED-ON 12-V  
 xVPP-SWITCH OUTPUT

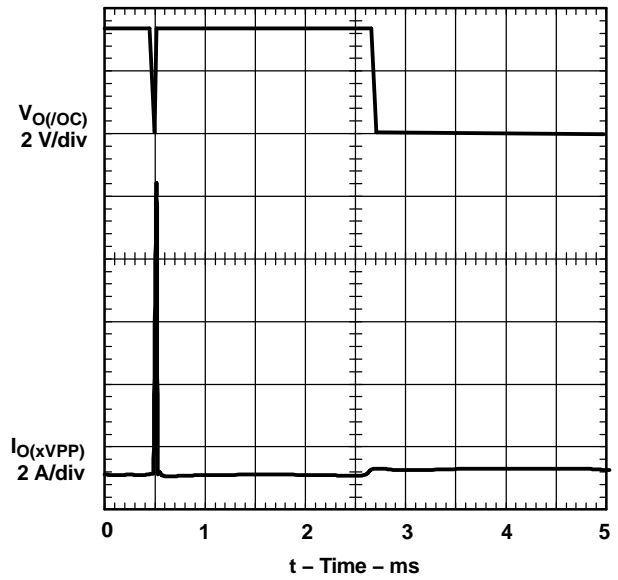

Figure 4.

OC RESPONSE WITH RAMPED  
 OVERCURRENT-LIMIT LOAD ON 5-V  
 xVCC-SWITCH OUTPUT

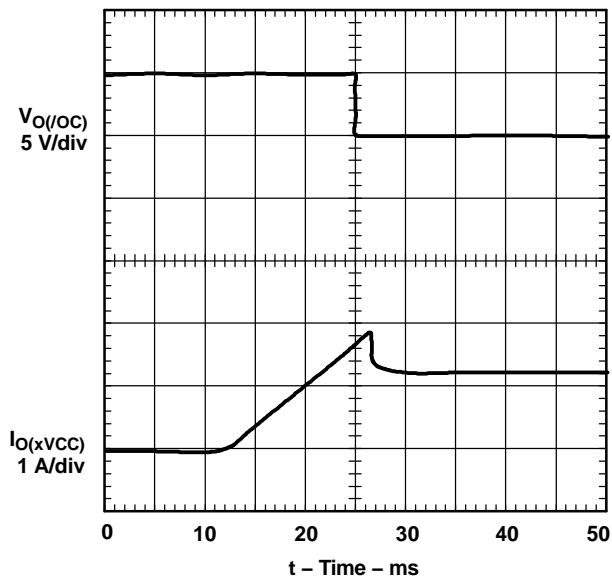

Figure 5.

OC RESPONSE WITH RAMPED  
 OVERCURRENT-LIMIT LOAD ON 12-V  
 xVPP-SWITCH OUTPUT

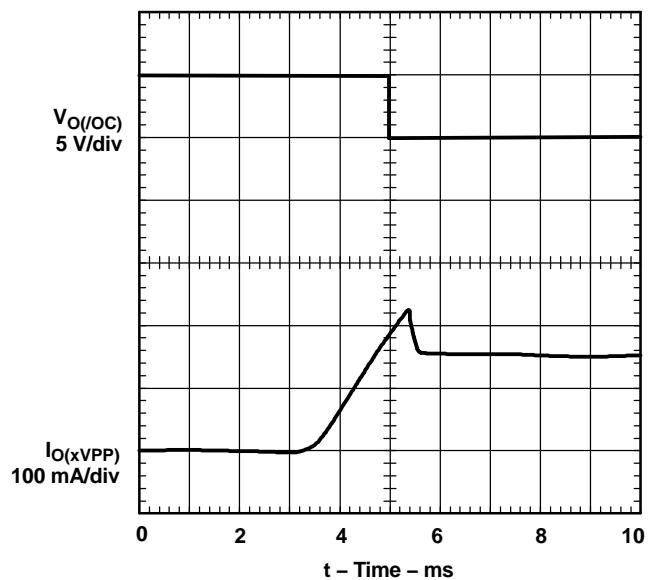

Figure 6.

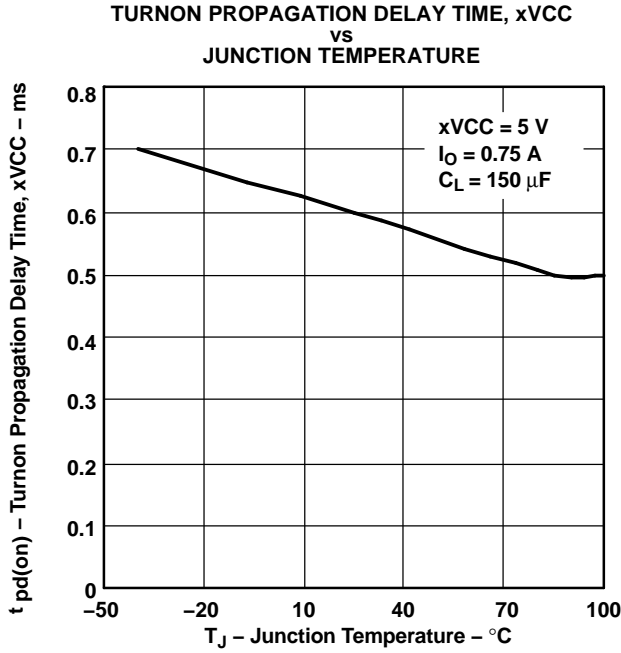

Figure 7.

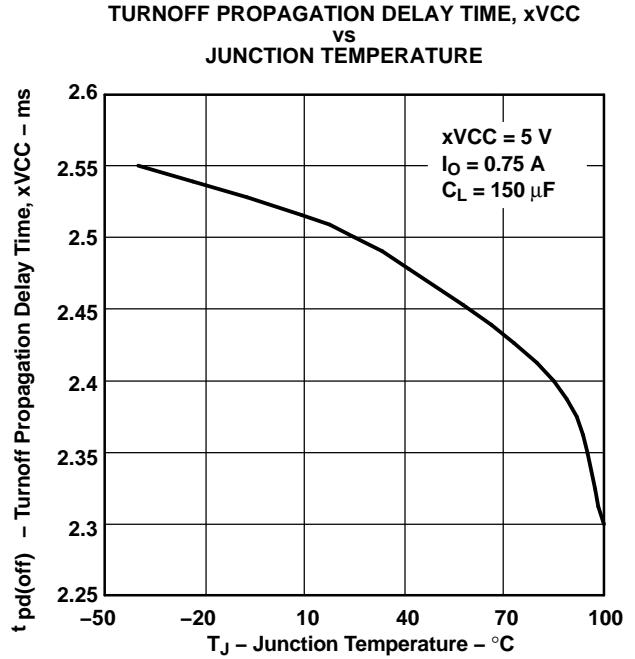

Figure 8.

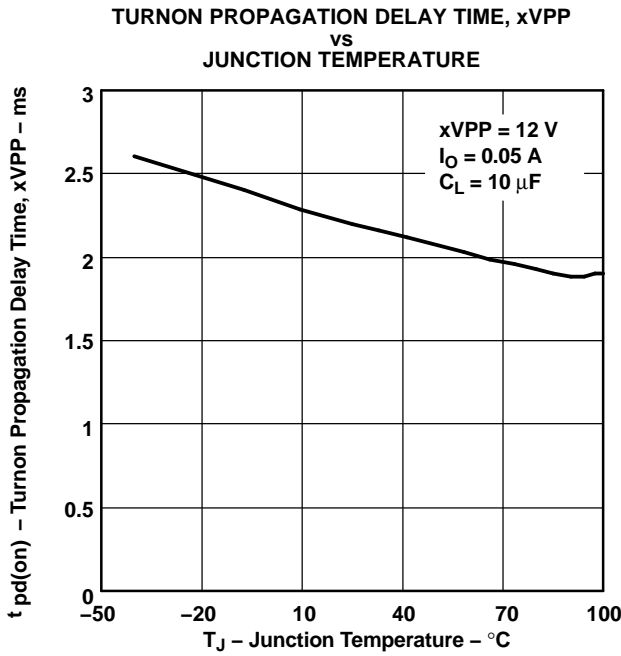

Figure 9.

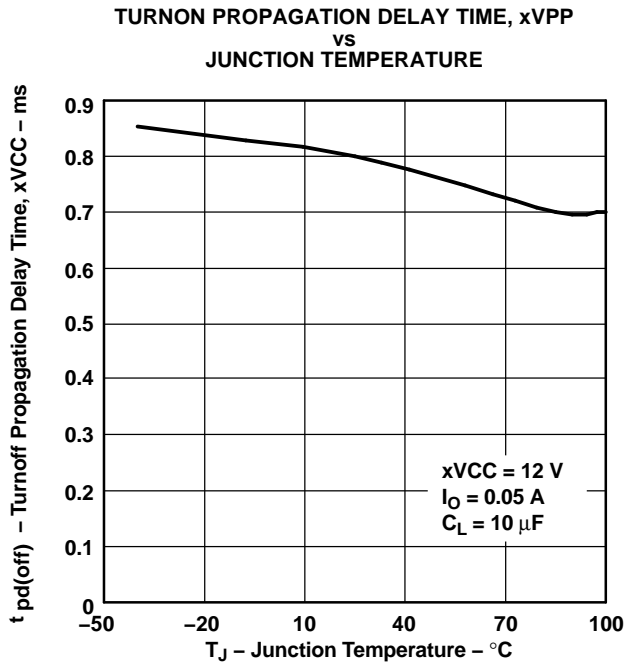

Figure 10.

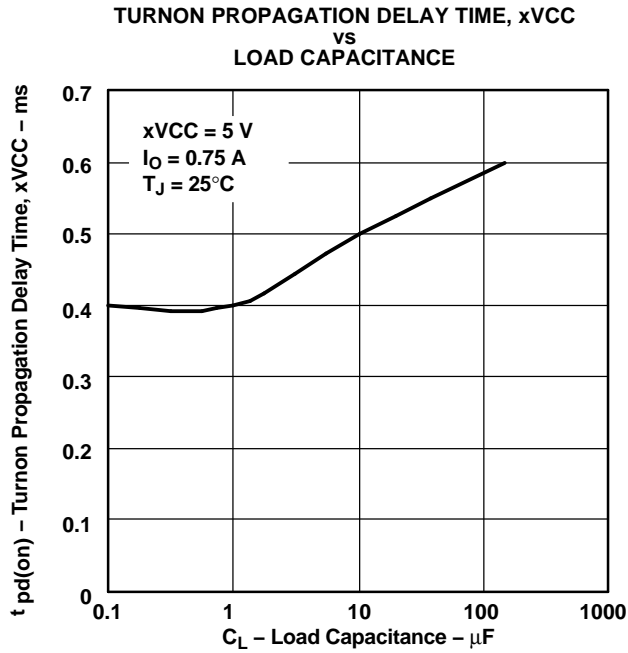

Figure 11.

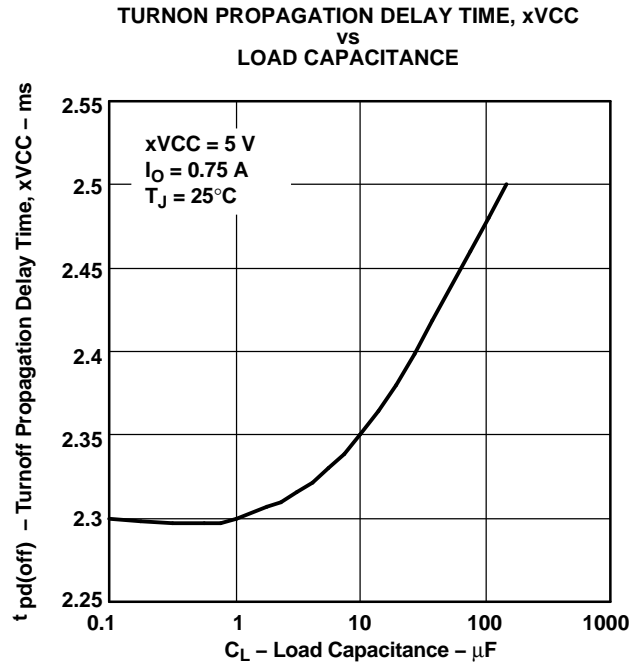

Figure 12.

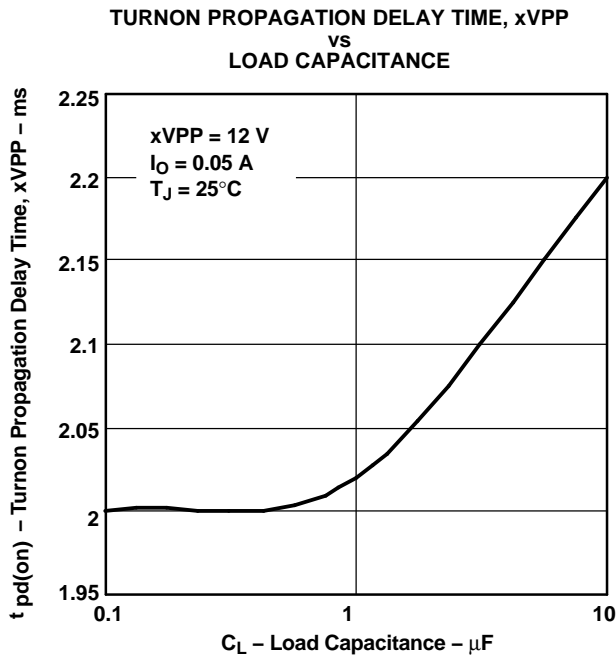

Figure 13.

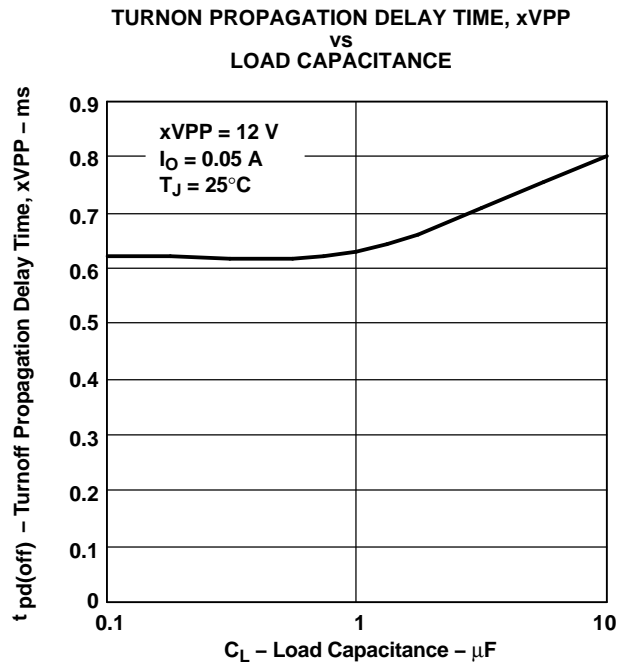

Figure 14.

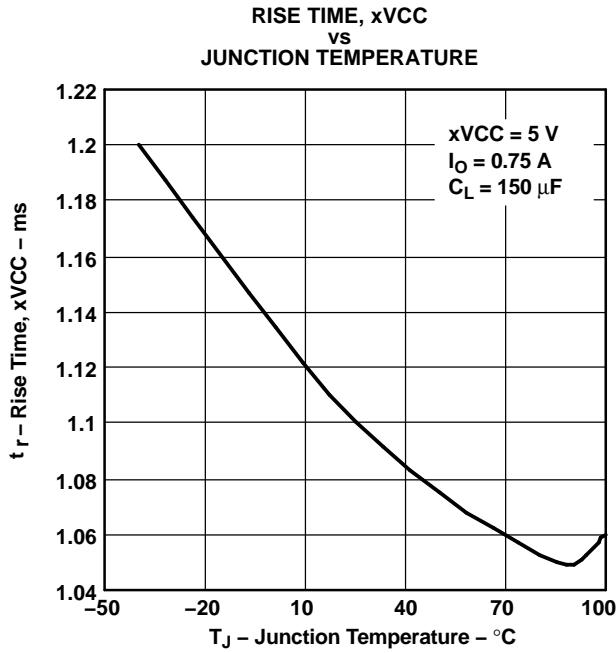

Figure 15.

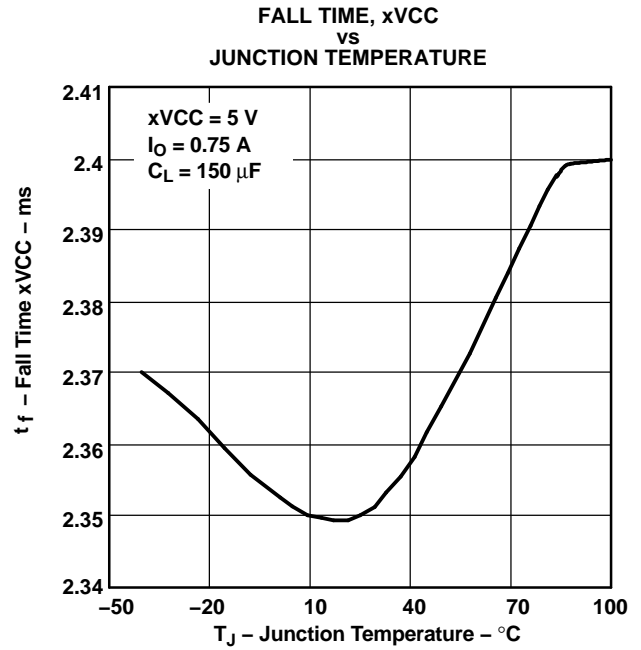

Figure 16.

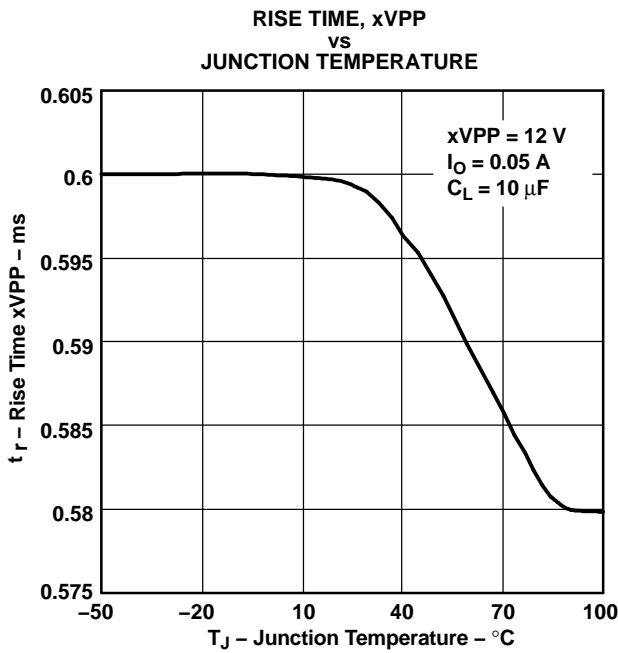

Figure 17.

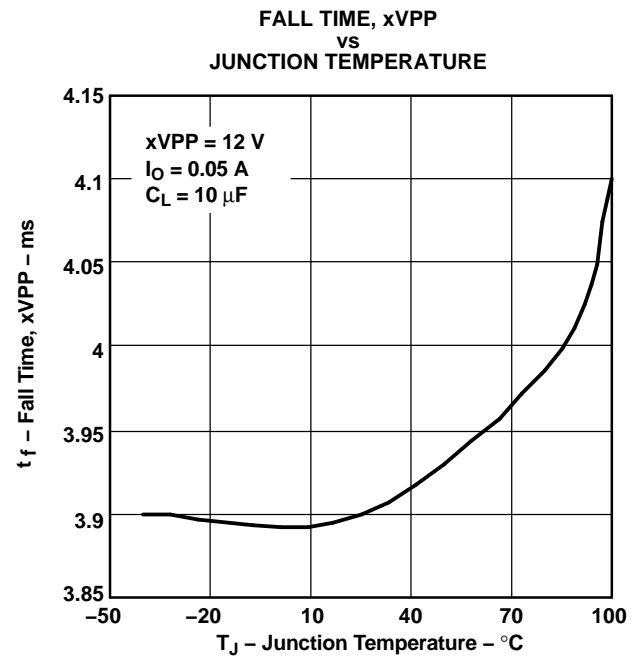

Figure 18.

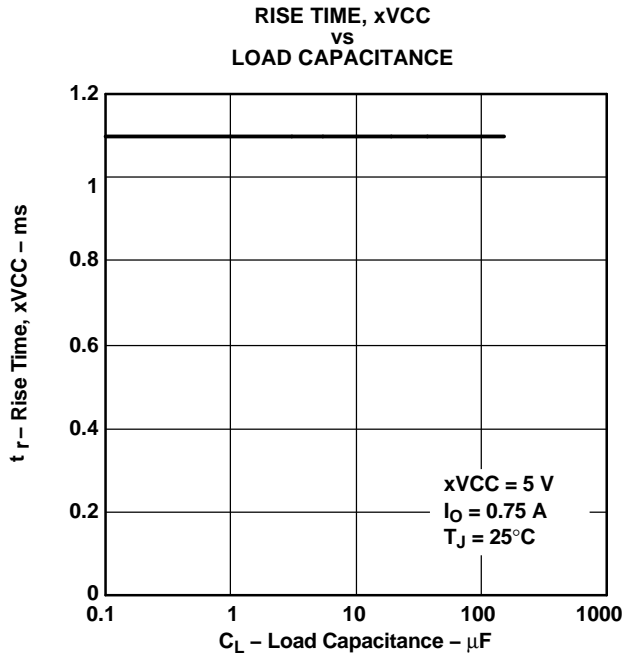

Figure 19.

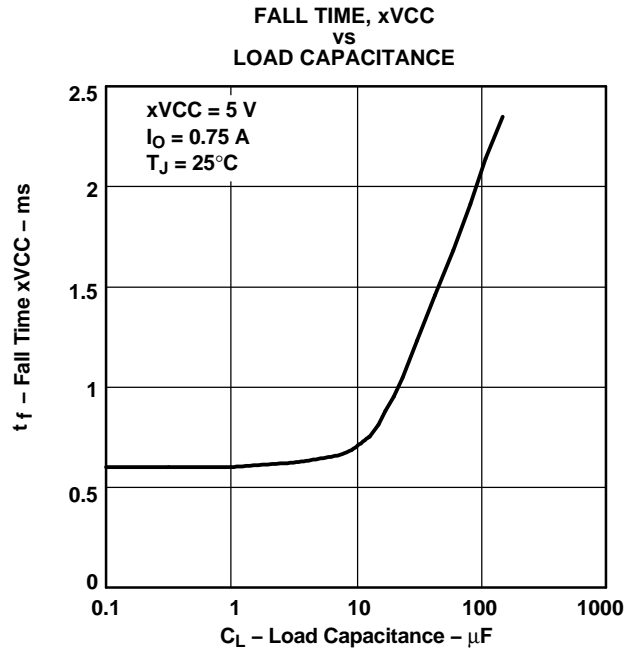

Figure 20.

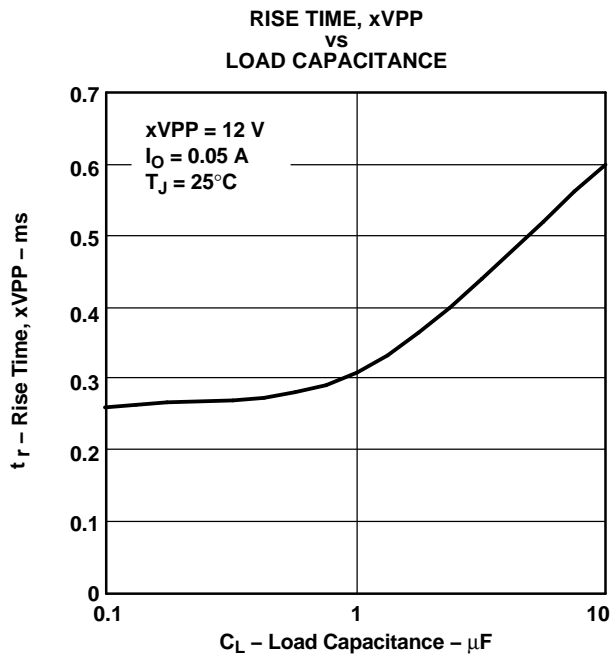

Figure 21.

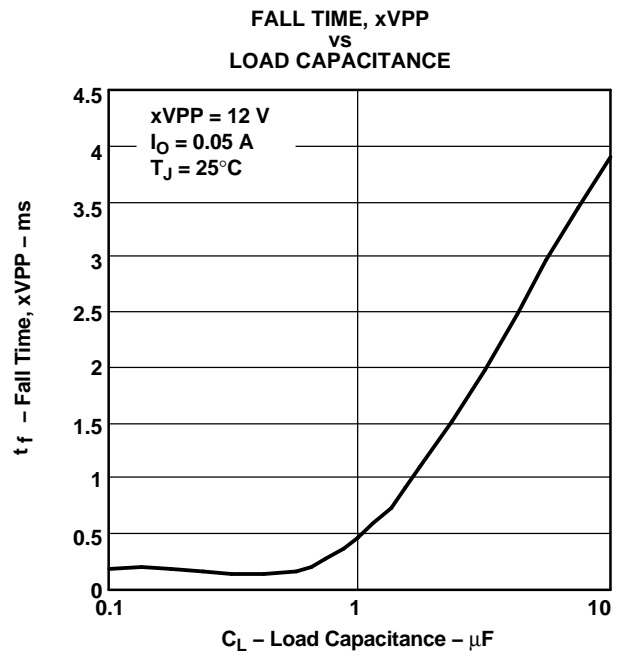

Figure 22.



## TYPICAL CHARACTERISTICS

### Table of Graphs

			FIGURE
$I_i$	Input current, $xVCC = 3.3\text{ V}$	vs Junction temperature	23
	Input current, $xVCC = 5\text{ V}$		24
	Input current, $xVPP = 12\text{ V}$		25
$r_{DS(on)}$	Static drain-source on-state resistance, 3.3 V to $xVCC$ switch	vs Junction temperature	26
	Static drain-source on-state resistance, 5 V to $xVCC$ switch		27
	Static drain-source on-state resistance, 12 V to $xVPP$ switch		28
$V_O$	$xVCC$ switch voltage drop, 3.3-V input	vs Load current	29
	$xVCC$ switch voltage drop, 5-V input		30
	$xVPP$ switch voltage drop, 12-V input		31
$I_{OS}$	Short-circuit current limit, 3.3 V to $xVCC$	vs Junction temperature	32
	Short-circuit current limit, 5 V to $xVCC$		33
	Short-circuit current limit, 12 V to $xVPP$		34

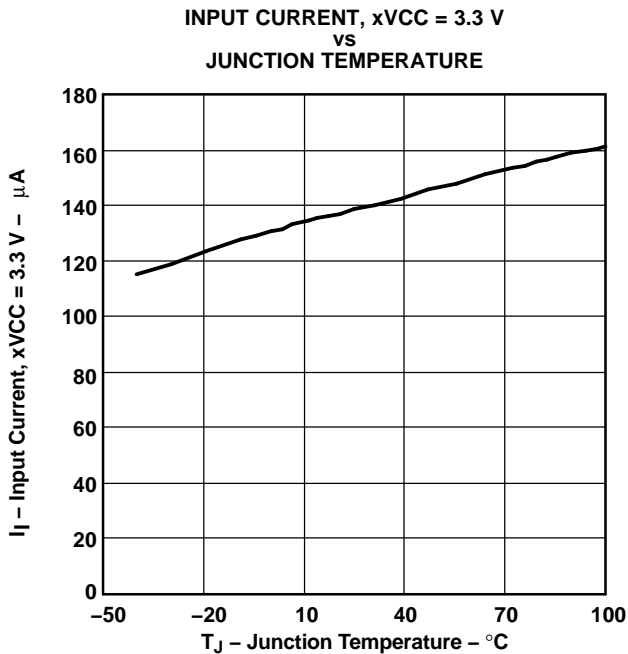

Figure 23.

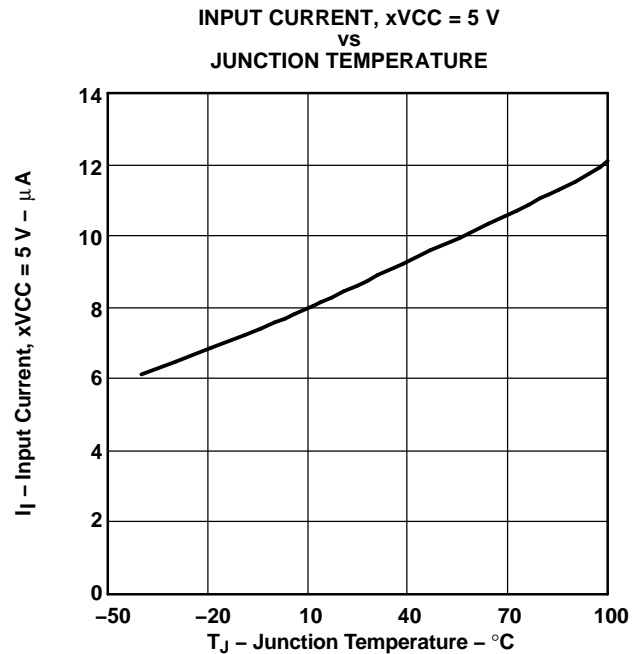

Figure 24.

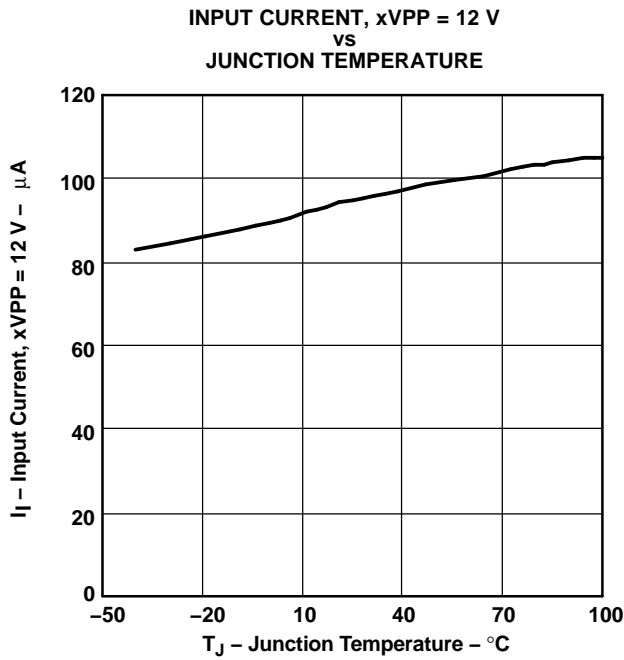

Figure 25.

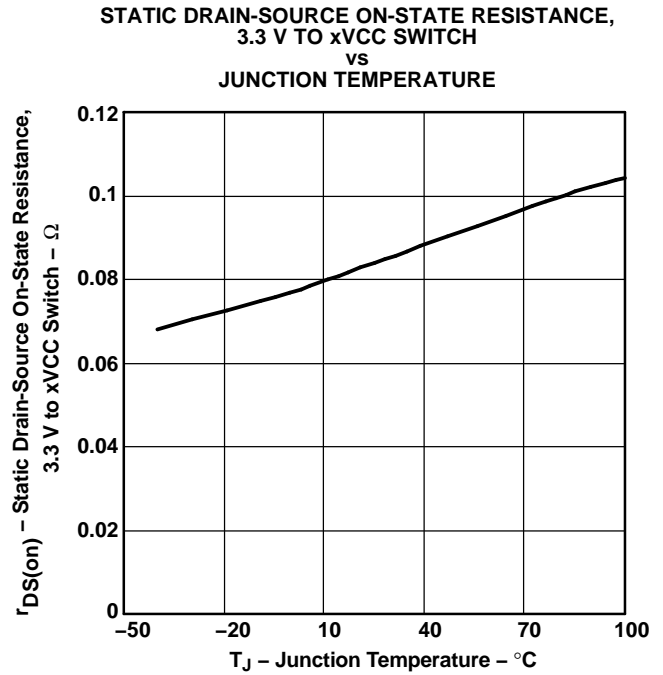

Figure 26.

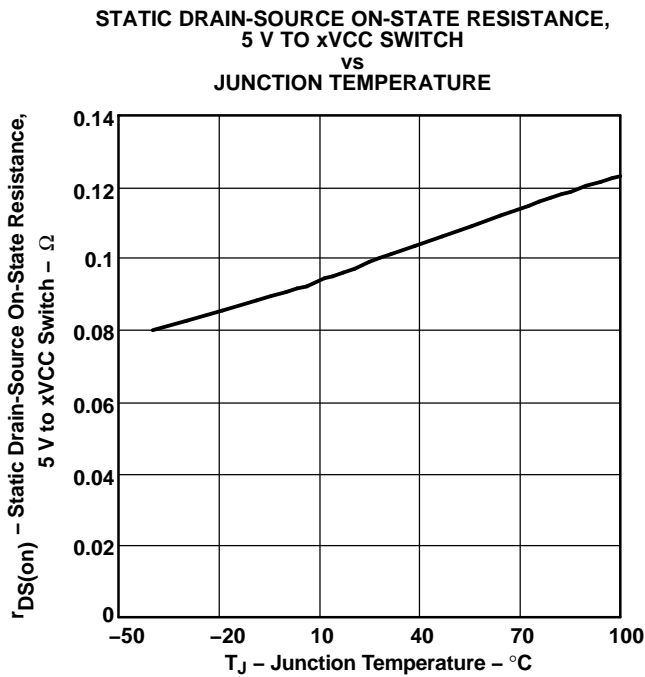

Figure 27.

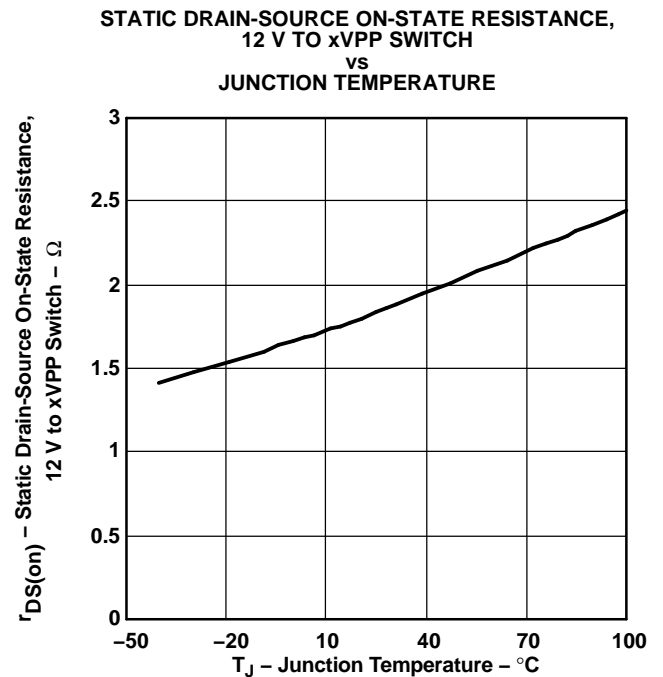

Figure 28.

xVCC SWITCH VOLTAGE DROP, 3.3-V INPUT  
VS  
LOAD CURRENT

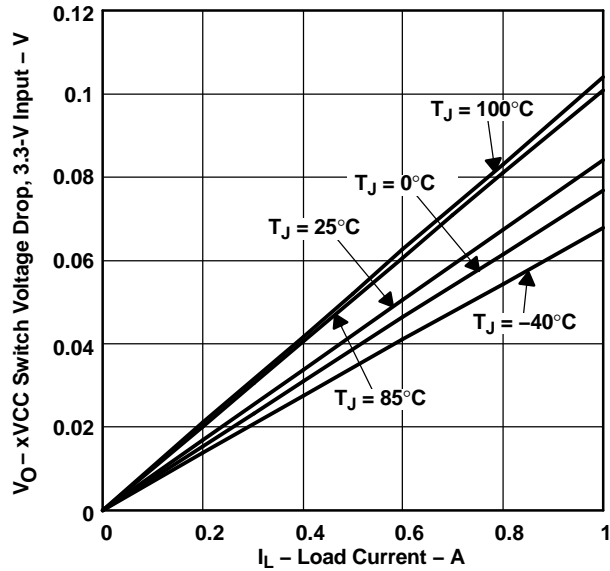

Figure 29.

xVCC SWITCH VOLTAGE DROP, 5-V INPUT  
VS  
LOAD CURRENT

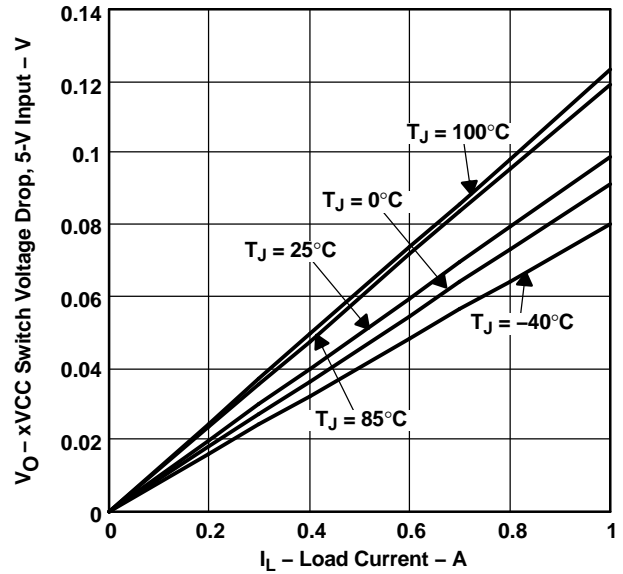

Figure 30.

xVPP SWITCH VOLTAGE DROP, 12-V INPUT  
VS  
LOAD CURRENT

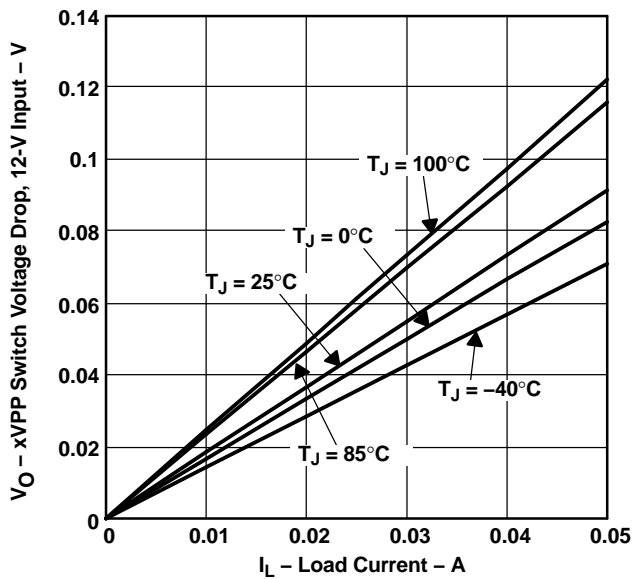

Figure 31.

SHORT-CIRCUIT CURRENT LIMIT, 3.3 V TO xVCC  
VS  
JUNCTION TEMPERATURE

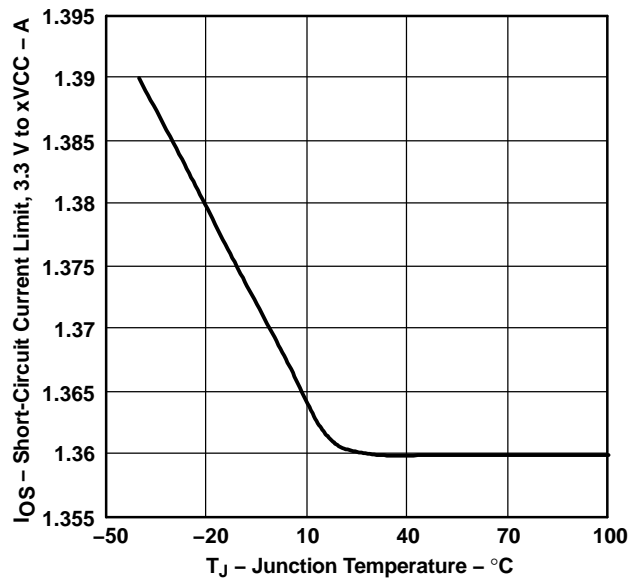

Figure 32.

SHORT-CIRCUIT CURRENT LIMIT, 5 V TO xVCC  
 VS  
 JUNCTION TEMPERATURE

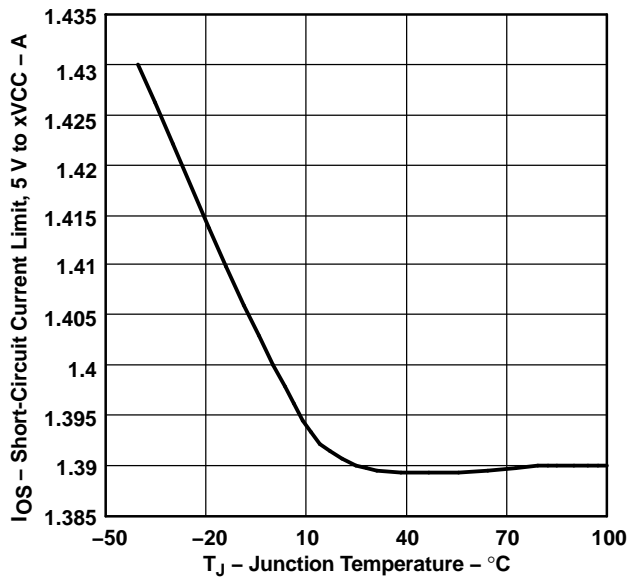

Figure 33.

SHORT-CIRCUIT CURRENT LIMIT, 12 V TO xVPP  
 VS  
 JUNCTION TEMPERATURE

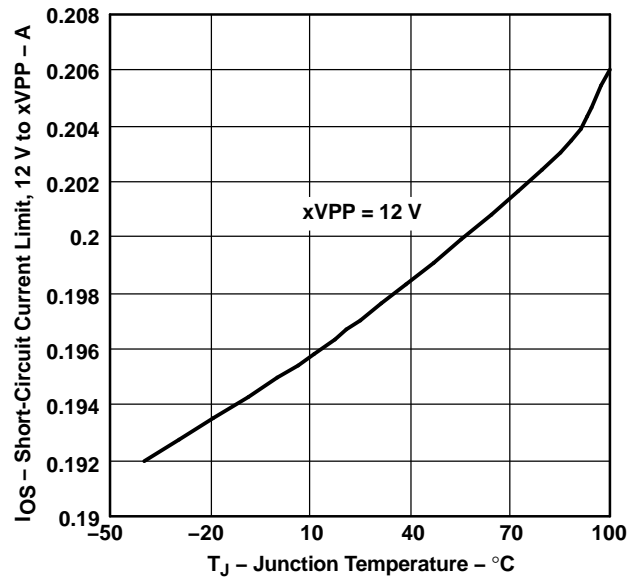

Figure 34.

## APPLICATION INFORMATION

### OVERVIEW

PC Cards were initially introduced as a means to add flash memory to portable computers. The idea of add-in cards quickly took hold, and modems, wireless LANs, global positioning satellite system (GPS), multimedia, and hard-disk versions were soon available. As the number of PC Card applications grew, the engineering community quickly recognized the need for a standard to ensure compatibility across platforms. Therefore, the PCMCIA (Personal Computer Memory Card International Association) was established, comprising members from leading computer, software, PC Card, and semiconductor manufacturers. One key goal was to realize the *plug-and-play* concept, so that cards and hosts from different vendors would be transparently compatible.

### PC CARD POWER SPECIFICATION

System compatibility also means power compatibility. The most current set of specifications (PC Card Standard) set forth by the PCMCIA committee states that power is to be transferred between the host and the card through eight of the 68 terminals of the PC Card connector. This power interface consists of two  $V_{CC}$ , two  $V_{pp}$ , and four ground terminals. Multiple  $V_{CC}$  and ground terminals minimize connector-terminal and line resistance. The two  $V_{pp}$  terminals were originally specified as separate signals, but are normally tied together in the host to form a single node to minimize voltage losses. Card primary power is supplied through the  $V_{CC}$  terminals; flash-memory programming and erase voltage is supplied through the  $V_{pp}$  terminals. Cardbus cards of today typically do not use 12 V, which is now more of an optional requirement in the host.

### DESIGNING FOR VOLTAGE REGULATION

The current PCMCIA specification for output voltage regulation,  $V_{O(\text{reg})}$ , of the 5-V output is 5% (250 mV). In a typical PC power-system design, the power supply has an output-voltage regulation,  $V_{PS(\text{reg})}$ , of 2% (100 mV). Also, a voltage drop from the power supply to the PC Card results from resistive losses,  $V_{PCB}$ , in the PCB traces and the PCMCIA connector. A typical design would limit the total of these resistive losses to less than 1% (50 mV) of the output voltage. Therefore, the allowable voltage drop,  $V_{DS}$ , for the TPS2220A, TPS2223A, TPS2224A, and TPS2226A would be the PCMCIA voltage regulation less the power supply regulation and less the PCB and connector resistive drops:

$$V_{DS} = V_{O(\text{reg})} - V_{PS(\text{reg})} - V_{PCB}$$

Typically, this would leave 100 mV for the allowable voltage drop across the 5-V switch. The specification for output voltage regulation of the 3.3-V output is 300 mV; therefore, using the same equation by deducting the voltage drop percentages (2%) for power-supply regulation and PCB resistive loss (1%), the allowable voltage drop for the 3.3-V switch is 200 mV. The voltage drop is the output current multiplied by the switch resistance of the device. Therefore, the maximum output current,  $I_{O \text{ max}}$ , that can be delivered to the PC Card in regulation is the allowable voltage drop across the IC, divided by the output-switch resistance.

$$I_{O \text{ max}} = \frac{V_{DS}}{r_{DS(\text{on})}}$$

The xVCC outputs have been designed to deliver the peak and average currents defined by the PC Card specification within regulation over the operating temperature range. The xVPP outputs of the device have been designed to deliver 100 mA continuously.

### OVERCURRENT AND OVERTEMPERATURE PROTECTION

PC Cards are inherently subject to damage that can result from mishandling. Host systems require protection against short-circuited cards that can lead to power-supply or PCB trace damage. Even extremely robust systems can undergo rapid battery discharge into a damaged PC Card, resulting in the sudden and unacceptable loss of system power. In comparison, the reliability of fused systems is poor because blown fuses require troubleshooting and repair, usually by the manufacturer.

The TPS2220A, TPS2223A, TPS2224A, and TPS2226A take a two-pronged approach to overcurrent protection, which is designed to activate if an output is shorted or when an overcurrent condition is present when switches are powered up. First, instead of fuses, sense FETs monitor each of the xVCC and xVPP power outputs. Unlike

## APPLICATION INFORMATION (continued)

sense resistors or polyfuses, these FETs do not add to the series resistance of the switch; therefore, voltage and power losses are reduced. Overcurrent sensing is applied to each output separately. Excessive current generates an error signal that limits the output current of only the affected output, preventing damage to the host. Each xVCC output overcurrent limits from 1 A to 2.2 A, typically around 1.6 A; the xVPP outputs limit from 100 mA to 250 mA, typically around 200 mA.

Second, when an overcurrent condition is detected, the TPS2220A, TPS2223A, TPS2224A, and TPS2226A assert an active low  $\overline{OC}$  signal that can be monitored by the microprocessor or controller to initiate diagnostics and/or send the user a warning message. If an overcurrent condition persists, causing the IC to exceed its maximum junction temperature, thermal-protection circuitry activates, shutting down all power outputs until the device cools to within a safe operating region, which is ensured by a thermal shutdown hysteresis. Thermal limiting prevents destruction of the IC from overheating beyond the package power-dissipation ratings.

During power up, the devices control the rise times of the xVCC and xVPP outputs and limit the inrush current into a large load capacitance, faulty card, or connector.

## 12-V SUPPLY NOT REQUIRED

Some PC Card switches use the externally supplied 12 V to power gate drive and other chip functions, which requires that power be present at all times. The TPS2220A, TPS2224A and TPS2226A offer considerable power savings by using an internal charge pump to generate the required higher gate drive voltages from the 3.3-V input. Therefore, the external 12-V supply can be disabled except when needed by the PC Card in the slot, thereby extending battery lifetime. A special feature in the 12-V circuitry actually helps to reduce the supply current demanded from the 3.3-V input. When 12 V is supplied and requested at the VPP output, a voltage selection circuit draws the charge-pump drive current for the 12-V FETs from the 12-V input. This selection is automatic and effectively reduces demand fluctuations on the normal 3.3-V VCC rail. For proper operation of this feature, a minimum 3.3-V input capacitance of 4.7  $\mu\text{F}$  is recommended, and a minimum 12-V input ramp-up rate of 12 V/50 ms (240 V/s) is required. Additional power savings are realized during a software shutdown in which quiescent current drops to a maximum of 1  $\mu\text{A}$ .

## VOLTAGE-TRANSITIONING REQUIREMENT

PC Cards, like portables, are migrating from 5 V to 3.3 V to minimize power consumption, optimize board space, and increase logic speeds. The TPS2220A, TPS2223A, TPS2224A, and TPS2226A meet all combinations of power delivery as currently defined in the PCMCIA standard. The latest protocol accommodates mixed 3.3-V/5-V systems by first powering the card with 5 V, then polling it to determine its 3.3-V compatibility. The PCMCIA specification requires that the capacitors on 3.3-V-compatible cards be discharged to below 0.8 V before applying 3.3-V power. This action ensures that sensitive 3.3-V circuitry is not subjected to any residual 5-V charge and functions as a power reset. PC Card specification requires that  $V_{CC}$  be discharged within 100 ms. PC Card resistance cannot be relied on to provide a discharge path for voltages stored on PC Card capacitance because of possible high-impedance isolation by power-management schemes. The devices include discharge transistors on all xVCC and xVPP outputs to meet the specification requirement.

## SHUTDOWN MODE

In the shutdown mode, which can be controlled by  $\overline{\text{SHDN}}$  or bit D8 of the input serial DATA word, each of the xVCC and xVPP outputs is forced to a high-impedance state. In this mode, the chip quiescent current is reduced to 1  $\mu\text{A}$  or less to conserve battery power.

## POWER-SUPPLY CONSIDERATIONS

These switches have multiple pins for each 3.3-V (except for TPS2220A) and 5-V power input and for the switched xVCC outputs. Any individual pin can conduct the rated input or output current. Unless all pins are connected in parallel, the series resistance is higher than that specified, resulting in increased voltage drops and power loss. It is recommended that all input and output power pins be paralleled for optimum operation.

To increase the noise immunity of the TPS2220A, TPS2223A, TPS2224A, and TPS2226A, the power-supply inputs should be bypassed with at least a 4.7- $\mu\text{F}$  electrolytic or tantalum capacitor paralleled by a 0.047- $\mu\text{F}$  to

## APPLICATION INFORMATION (continued)

0.1- $\mu$ F ceramic capacitor. It is strongly recommended that the switched outputs be bypassed with a 0.1- $\mu$ F (or larger) ceramic capacitor; doing so improves the immunity of the IC to electrostatic discharge (ESD). Care should be taken to minimize the inductance of PCB traces between the devices and the load. High switching currents can produce large negative voltage transients, which forward biases substrate diodes, resulting in unpredictable performance. Similarly, no pin should be taken below -0.3 V.

## RESET INPUT

To ensure that cards are in a known state after power brownouts or system initialization, the PC Cards should be reset at the same time as the host by applying low-impedance paths from xVCC and xVPP terminals to ground. A low-impedance output state allows discharging of residual voltage remaining on PC Card filter capacitance, permitting the system (host and PC Cards) to be powered up concurrently. The active low  $\overline{\text{RESET}}$  input closes internal ground switches S1, S4, S7, and S11 with all other switches left open. The TPS2220A, TPS2223A, TPS2224A, and TPS2226A remain in the low-impedance output state until the signal is deasserted and further data is clocked in and latched. The input serial data cannot be latched during reset mode.  $\overline{\text{RESET}}$  is provided for direct compatibility with systems that use an active-low reset voltage supervisor. The  $\overline{\text{RESET}}$  pin has an internal 150-k $\Omega$  pullup resistor.

## CALCULATING JUNCTION TEMPERATURE

The switch resistance,  $r_{\text{DS(on)}}$ , is dependent on the junction temperature,  $T_J$ , of the die. The junction temperature is dependent on both  $r_{\text{DS(on)}}$  and the current through the switch. To calculate  $T_J$ , first find  $r_{\text{DS(on)}}$  from Figure 26 through Figure 28, using an initial temperature estimate about 30°C above ambient. Then, calculate the power dissipation for each switch, using the formula:

$$P_D = r_{\text{DS(on)}} \times I^2$$

Next, sum the power dissipation of all switches and calculate the junction temperature:

$$T_J = \left( \sum P_D \times R_{\theta\text{JA}} \right) + T_A$$

where:

$R_{\theta\text{JA}}$  is the inverse of the derating factor given in the dissipation rating table.

Compare the calculated junction temperature with the initial temperature estimate. If the temperatures are not within a few degrees of each other, recalculate using the calculated temperature as the initial estimate.

## LOGIC INPUTS AND OUTPUTS

The serial interface consists of the DATA, CLOCK, and LATCH leads. The data is clocked in on the positive edge of the clock (see Figure 2). The 11-bit (D0-D10) serial data word is loaded during the positive edge of the latch signal. The positive edge of the latch signal should occur before the next positive edge of the clock occurs.

The serial interface of the device is compatible with serial-interface PCMCIA controllers.

An overcurrent output ( $\overline{\text{OC}}$ ) is provided to indicate an overcurrent or overtemperature condition in any of the xVCC and xVPP outputs as previously discussed.

**TPS2220A, TPS2223A, TPS2224A, and TPS2226A CONTROL LOGIC**

<i>xVPP</i>									
AVPP CONTROL SIGNALS				OUTPUT V_AVPP	BVPP CONTROL SIGNALS				OUTPUT V_BVPP
D8 ( $\overline{\text{SHDN}}$ )	D0	D1	D9		D8 ( $\overline{\text{SHDN}}$ )	D4	D5	D10	
1	0	0	X	0 V	1	0	0	X	0 V
1	0	1	0	3.3 V	1	0	1	0	3.3 V
1	0	1	1	5 V	1	0	1	1	5 V
1	1	0	X	12 V <sup>(1)</sup>	1	1	0	X	12 V <sup>(1)</sup>
1	1	1	X	Hi-Z	1	1	1	X	Hi-Z
0	X	X	X	Hi-Z	0	X	X	X	Hi-Z

(1) The output V\_xVPP is Hi-Z for TPS2223A.

<i>xVCC</i>							
AVCC CONTROL SIGNALS			OUTPUT V_AVCC	BVCC CONTROL SIGNALS			OUTPUT V_BVCC
D8 ( $\overline{\text{SHDN}}$ )	D3	D2		D8 ( $\overline{\text{SHDN}}$ )	D6	D7	
1	0	0	0 V	1	0	0	0 V
1	0	1	3.3 V	1	0	1	3.3 V
1	1	0	5 V	1	1	0	5 V
1	1	1	0 V	1	1	1	0 V
0	X	X	Hi-Z	0	X	X	Hi-Z



### ESD PROTECTIONS (see Figure 35)

All inputs and outputs of these devices incorporate ESD-protection circuitry designed to withstand a 2-kV human-body-model discharge as defined in MIL-STD-883C, Method 3015. The xVCC and xVPP outputs can be exposed to potentially higher discharges from the external environment through the PC Card connector. Bypassing the outputs with 0.1- $\mu$ F capacitors protects the devices from discharges up to 10 kV.

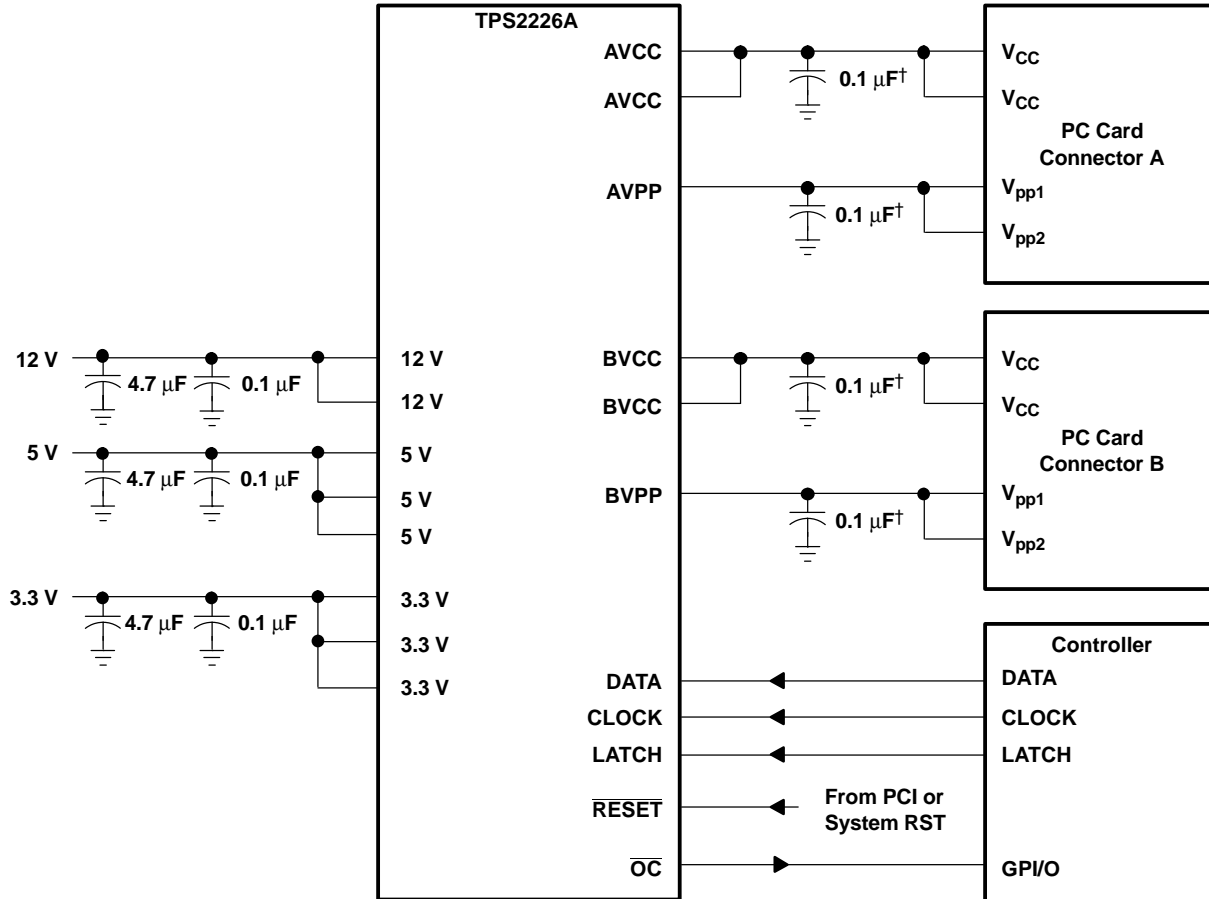

† Maximum recommended output capacitance for xVCC is 220  $\mu$ F including card capacitance, and for xVPP is 10  $\mu$ F, without  $\overline{OC}$  glitch when switches are powered on.

**Figure 35. Detailed Interconnections and Capacitor Recommendations**

## 12-V FLASH MEMORY SUPPLY

The TPS6734 is a fixed 12-V output boost converter capable of delivering 120 mA from inputs as low as 2.7 V. The device is pin-for-pin compatible with the MAX734 regulator and offers the following advantages: lower supply current, wider operating input-voltage range, and higher output currents. As shown in Figure 36, the only external components required are: an inductor, a Schottky rectifier, an output filter capacitor, an input filter capacitor, and a small capacitor for loop compensation. The entire converter occupies less than 0.7 in<sup>2</sup> of PCB space when implemented with surface-mount components. An enable input is provided to shut the converter down and reduce the supply current to 3  $\mu$ A when 12 V is not needed.

The TPS6734 is a 170-kHz current-mode PWM (pulse-width modulation) controller with an n-channel MOSFET power switch. Gate drive for the switch is derived from the 12-V output after start-up to minimize the die area needed to realize the 0.7- $\Omega$  MOSFET and improve efficiency at input voltages below 5 V. Soft start is accomplished with the addition of one small capacitor. A 1.22-V reference, pin 2 of TPS6734, is brought out for external use. For additional information, see the TPS6734 data sheet (SLVS127).

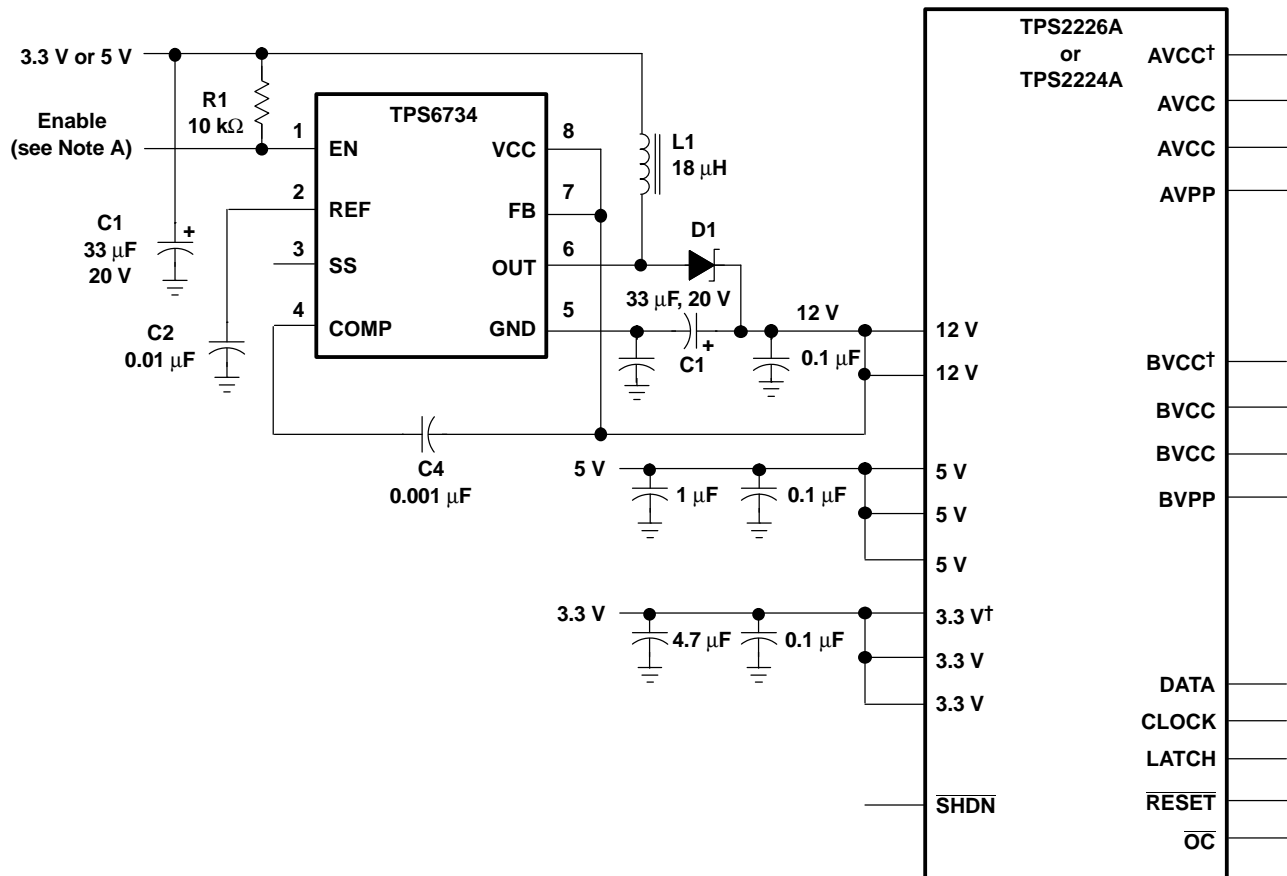

† Not on TPS2224A

NOTE A: The enable terminal can be tied to a general-purpose I/O terminal on the PCMCIA controller or tied high.

Figure 36. TPS2224A and TPS2226A with TPS6734 12-V, 120-mA Supply

PWP (R-PDSO-G\*\*) 20 PIN SHOWN

PowerPAD™ PLASTIC SMALL-OUTLINE PACKAGE

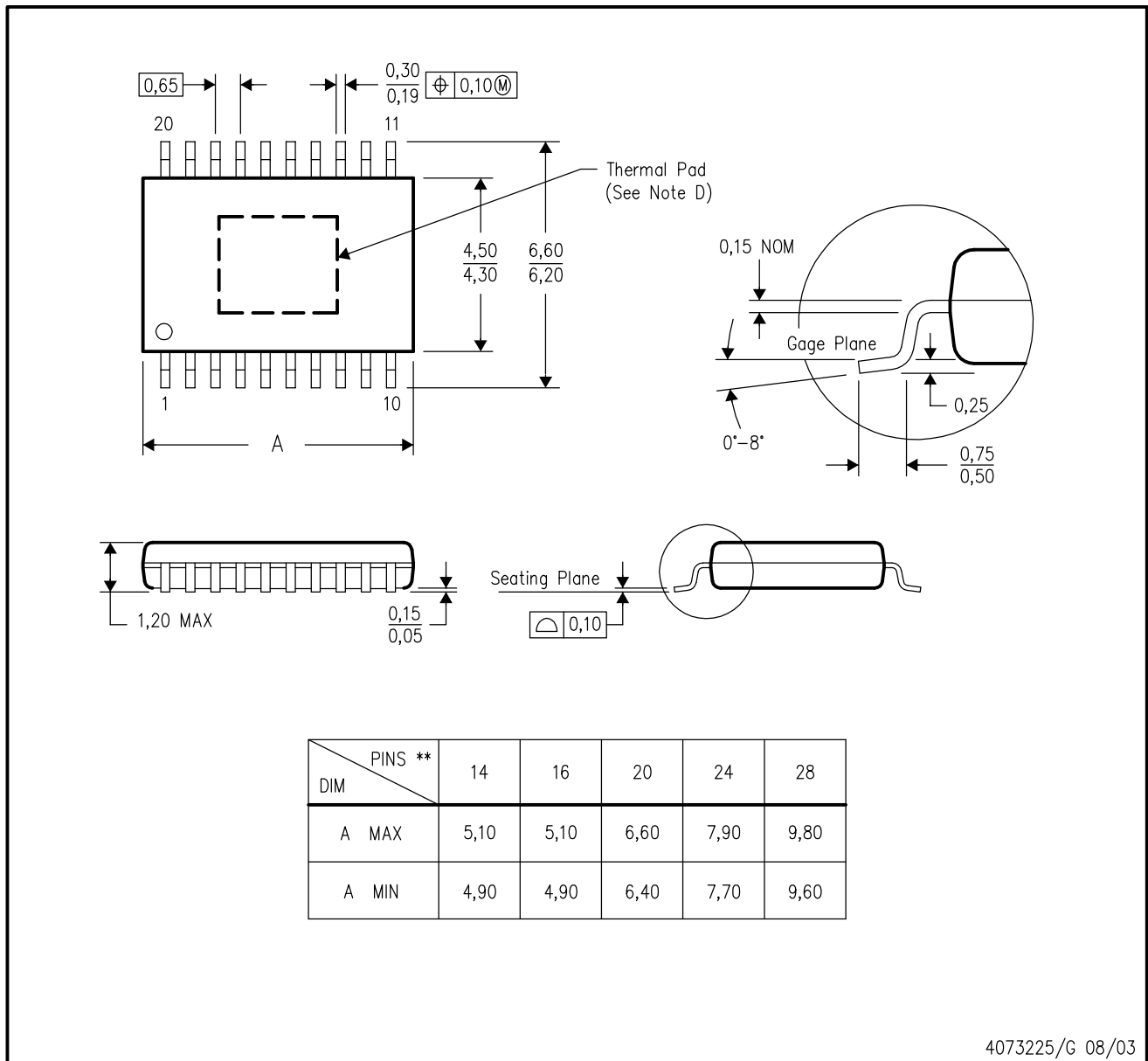

4073225/G 08/03

- NOTES:
- A. All linear dimensions are in millimeters.
  - B. This drawing is subject to change without notice.
  - C. Body dimensions do not include mold flash or protrusions.
  - D. This package is designed to be soldered to a thermal pad on the board. Refer to Technical Brief, PowerPad Thermally Enhanced Package, Texas Instruments Literature No. SLMA002 for information regarding recommended board layout. This document is available at [www.ti.com](http://www.ti.com) <<http://www.ti.com>>.
  - E. Falls within JEDEC MO-153

PowerPAD is a trademark of Texas Instruments.

DB (R-PDSO-G\*\*)

PLASTIC SMALL-OUTLINE

28 PINS SHOWN



- NOTES: A. All linear dimensions are in millimeters.  
 B. This drawing is subject to change without notice.  
 C. Body dimensions do not include mold flash or protrusion not to exceed 0,15.  
 D. Falls within JEDEC MO-150

4040065 /E 12/01

## IMPORTANT NOTICE

Texas Instruments Incorporated and its subsidiaries (TI) reserve the right to make corrections, modifications, enhancements, improvements, and other changes to its products and services at any time and to discontinue any product or service without notice. Customers should obtain the latest relevant information before placing orders and should verify that such information is current and complete. All products are sold subject to TI's terms and conditions of sale supplied at the time of order acknowledgment.

TI warrants performance of its hardware products to the specifications applicable at the time of sale in accordance with TI's standard warranty. Testing and other quality control techniques are used to the extent TI deems necessary to support this warranty. Except where mandated by government requirements, testing of all parameters of each product is not necessarily performed.

TI assumes no liability for applications assistance or customer product design. Customers are responsible for their products and applications using TI components. To minimize the risks associated with customer products and applications, customers should provide adequate design and operating safeguards.

TI does not warrant or represent that any license, either express or implied, is granted under any TI patent right, copyright, mask work right, or other TI intellectual property right relating to any combination, machine, or process in which TI products or services are used. Information published by TI regarding third-party products or services does not constitute a license from TI to use such products or services or a warranty or endorsement thereof. Use of such information may require a license from a third party under the patents or other intellectual property of the third party, or a license from TI under the patents or other intellectual property of TI.

Reproduction of information in TI data books or data sheets is permissible only if reproduction is without alteration and is accompanied by all associated warranties, conditions, limitations, and notices. Reproduction of this information with alteration is an unfair and deceptive business practice. TI is not responsible or liable for such altered documentation.

Resale of TI products or services with statements different from or beyond the parameters stated by TI for that product or service voids all express and any implied warranties for the associated TI product or service and is an unfair and deceptive business practice. TI is not responsible or liable for any such statements.

Following are URLs where you can obtain information on other Texas Instruments products and application solutions:

<b>Products</b>		<b>Applications</b>	
Amplifiers	<a href="http://amplifier.ti.com">amplifier.ti.com</a>	Audio	<a href="http://www.ti.com/audio">www.ti.com/audio</a>
Data Converters	<a href="http://dataconverter.ti.com">dataconverter.ti.com</a>	Automotive	<a href="http://www.ti.com/automotive">www.ti.com/automotive</a>
DSP	<a href="http://dsp.ti.com">dsp.ti.com</a>	Broadband	<a href="http://www.ti.com/broadband">www.ti.com/broadband</a>
Interface	<a href="http://interface.ti.com">interface.ti.com</a>	Digital Control	<a href="http://www.ti.com/digitalcontrol">www.ti.com/digitalcontrol</a>
Logic	<a href="http://logic.ti.com">logic.ti.com</a>	Military	<a href="http://www.ti.com/military">www.ti.com/military</a>
Power Mgmt	<a href="http://power.ti.com">power.ti.com</a>	Optical Networking	<a href="http://www.ti.com/opticalnetwork">www.ti.com/opticalnetwork</a>
Microcontrollers	<a href="http://microcontroller.ti.com">microcontroller.ti.com</a>	Security	<a href="http://www.ti.com/security">www.ti.com/security</a>
		Telephony	<a href="http://www.ti.com/telephony">www.ti.com/telephony</a>
		Video & Imaging	<a href="http://www.ti.com/video">www.ti.com/video</a>
		Wireless	<a href="http://www.ti.com/wireless">www.ti.com/wireless</a>

Mailing Address: Texas Instruments  
Post Office Box 655303 Dallas, Texas 75265