

Lithium Manganese Dioxide Battery **CR2430**

■ Dimensions (mm)

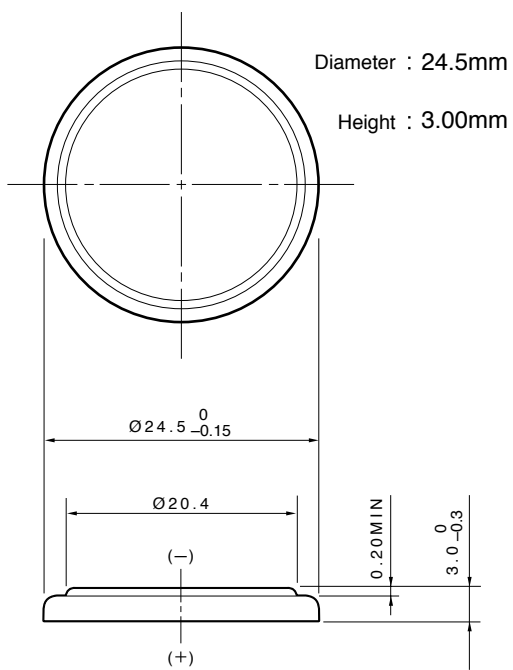

■ Specifications

Nominal Voltage	3V
Nominal Capacity (2.5V cutoff)	280mAh
Recommended Continuous Drain	0.4mA
Recommended Pulse Drain	21mA
Weight	4.6g

Applications

- Memory Back-up Power Source for SRAM or Real Time Clock (RTC)

■ Discharge Characteristics

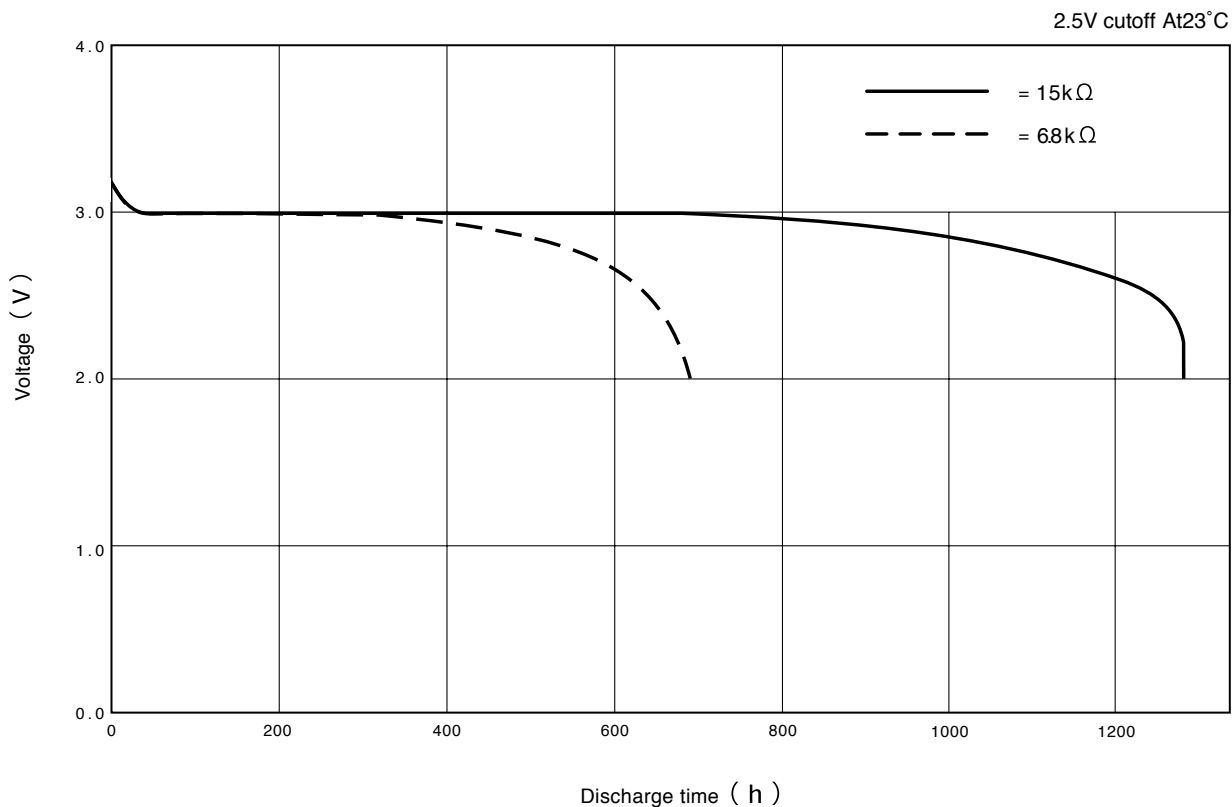

Discharge Characteristics on Load

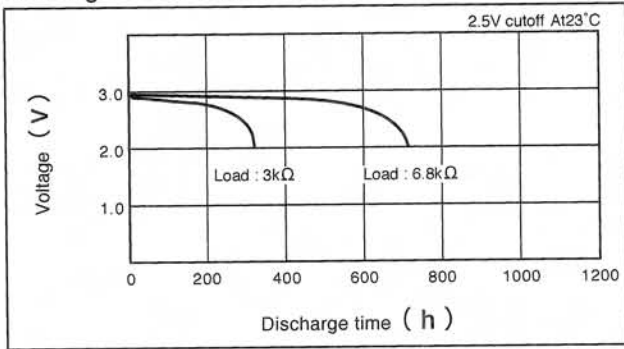

Discharge Characteristics on Temperature

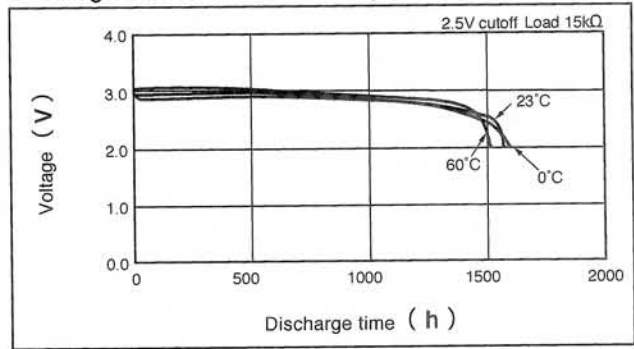

Discharge Load vs. Operation Voltage (Discharge depth 40%)

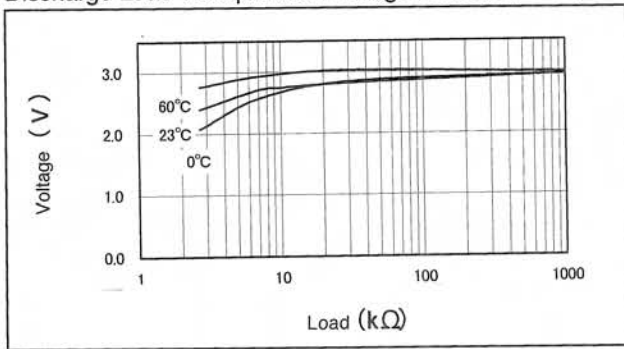

Discharge Load vs. Discharge Capacity

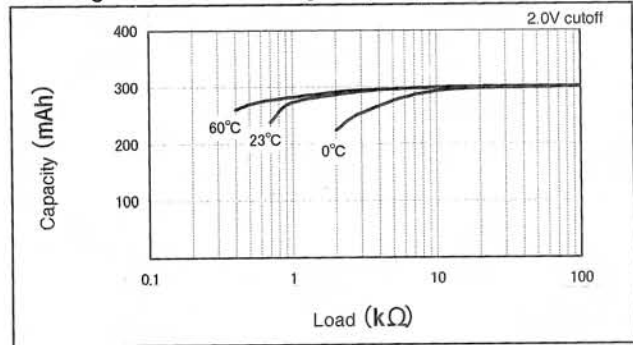

Discharge Characteristics on Pulse Load (Discharge depth 40%)

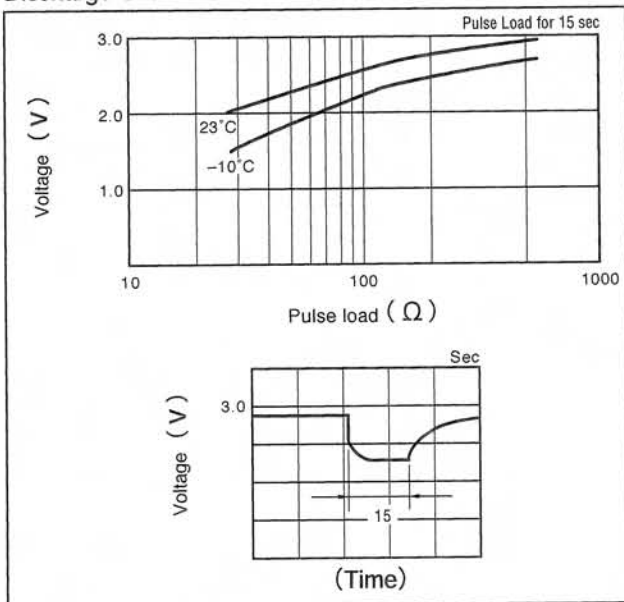

Storage Characteristics

