

NDC7001C Dual N & P-Channel Enhancement Mode Field Effect Transistor

General Description

These dual N and P-channel enhancement mode power field effect transistors are produced using Fairchild's proprietary, high cell density, DMOS technology. This very high density process has been designed to minimize on-state resistance, provide rugged and reliable performance and fast switching. These devices is particularly suited for low voltage, low current, switching, and power supply applications.

Features

- N-Channel 0.51A, 50V, $R_{DS(ON)} = 2\Omega @ V_{GS}=10V$
- P-Channel -0.34A, -50V. $R_{DS(ON)} = 5\Omega @ V_{GS}=-10V$.
- High density cell design for low $R_{DS(ON)}$.
- Proprietary SuperSOT™-6 package design using copper lead frame for superior thermal and electrical capabilities.
- High saturation current.

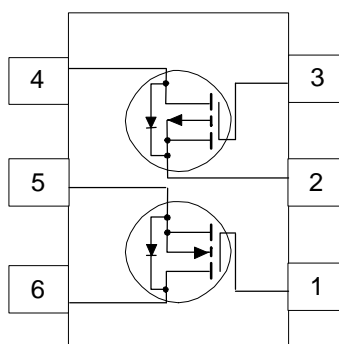
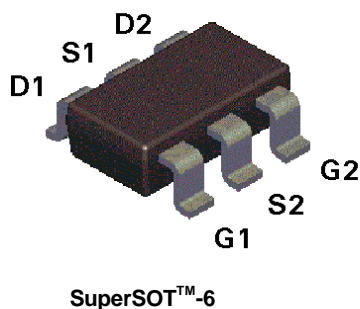

Absolute Maximum Ratings $T_A = 25^\circ\text{C}$ unless otherwise noted

Symbol	Parameter	N-Channel	P-Channel	Units
V_{DSS}	Drain-Source Voltage	50	-50	V
V_{GSS}	Gate-Source Voltage - Continuous	20	-20	V
I_D	Drain Current - Continuous (Note 1a)	0.51	-0.34	A
	- Pulsed	1.5	-1	
P_D	Maximum Power Dissipation (Note 1a) (Note 1b) (Note 1c)	0.96		W
		0.9		
		0.7		
T_J, T_{STG}	Operating and Storage Temperature Range	-55 to 150		$^\circ\text{C}$

THERMAL CHARACTERISTICS

$R_{\theta JA}$	Thermal Resistance, Junction-to-Ambient (Note 1a)	130	$^\circ\text{C}/\text{W}$
$R_{\theta JC}$	Thermal Resistance, Junction-to-Case (Note 1)	60	$^\circ\text{C}/\text{W}$

ELECTRICAL CHARACTERISTICS ($T_A = 25^\circ\text{C}$ unless otherwise noted)

Symbol	Parameter	Conditions	Type	Min	Typ	Max	Units
OFF CHARACTERISTICS							
BV_{DSS}	Drain-Source Breakdown Voltage	$V_{GS} = 0\text{ V}, I_D = 250\ \mu\text{A}$	N-Ch	50			V
		$V_{GS} = 0\text{ V}, I_D = -250\ \mu\text{A}$	P-Ch	-50			
I_{DSS}	Zero Gate Voltage Drain Current	$V_{DS} = 40\text{ V}, V_{GS} = 0\text{ V}$	N-Ch			1	μA
				$T_J = 125^\circ\text{C}$			
		$V_{DS} = -40\text{ V}, V_{GS} = 0\text{ V}$	P-Ch			-1	
				$T_J = 125^\circ\text{C}$			
I_{GSSF}	Gate - Body Leakage, Forward	$V_{GS} = 20\text{ V}, V_{DS} = 0\text{ V}$	All			100	nA
I_{GSSR}	Gate - Body Leakage, Reverse	$V_{GS} = -20\text{ V}, V_{DS} = 0\text{ V}$	All			-100	nA
ON CHARACTERISTICS (Note 2)							
$V_{GS(th)}$	Gate Threshold Voltage	$V_{DS} = V_{GS}, I_D = 250\ \mu\text{A}$	N-Ch	1	1.9	2.5	V
				$T_J = 125^\circ\text{C}$	0.8	1.5	
		$V_{DS} = V_{GS}, I_D = -250\ \mu\text{A}$	P-Ch	-1	-2.5	-3.5	
				$T_J = 125^\circ\text{C}$	-0.8	-2.2	
$R_{DS(on)}$	Static Drain-Source On-Resistance	$V_{GS} = 10\text{ V}, I_D = 0.51\text{ A}$	N-Ch		1	2	Ω
				$T_J = 125^\circ\text{C}$		1.7	
		$V_{GS} = 4.5\text{ V}, I_D = 0.35\text{ A}$	N-Ch		1.6	4	
				$T_J = 125^\circ\text{C}$		1.6	
		$V_{GS} = -10\text{ V}, I_D = -0.34\text{ A}$	P-Ch		2.5	5	
				$T_J = 125^\circ\text{C}$		4	
$V_{GS} = -4.5\text{ V}, I_D = -0.25\text{ A}$	P-Ch		5.3	7.5			
$I_{D(on)}$	On-State Drain Current	$V_{GS} = 10\text{ V}, V_{DS} = 10\text{ V}$	N-Ch	1.5			A
		$V_{GS} = -10\text{ V}, V_{DS} = -10\text{ V}$	P-Ch	-1			
g_{FS}	Forward Transconductance	$V_{DS} = 10\text{ V}, I_D = 0.51\text{ A}$	N-Ch		400		mS
		$V_{DS} = -10\text{ V}, I_D = -0.34\text{ A}$	P-Ch		250		
DYNAMIC CHARACTERISTICS							
C_{iss}	Input Capacitance	N-Channel $V_{DS} = 25\text{ V}, V_{GS} = 0\text{ V},$ $f = 1.0\text{ MHz}$	N-Ch		20		pF
			P-Ch		40		
C_{oss}	Output Capacitance	P-Channel $V_{DS} = -25\text{ V}, V_{GS} = 0\text{ V},$ $f = 1.0\text{ MHz}$	N-Ch		13		pF
			P-Ch		13		
C_{rss}	Reverse Transfer Capacitance		N-Ch		5		pF
			P-Ch		4		

Electrical Characteristics ($T_A = 25^\circ\text{C}$ unless otherwise noted)

Symbol	Parameters	Conditions	Type	Min	Typ	Max	Units
SWITCHING CHARACTERISTICS (Note 2)							
$t_{D(on)}$	Turn - On Delay Time	N-Channel $V_{DD} = 25\text{ V}$, $I_D = 0.25\text{ A}$, $V_{GS} = 10\text{ V}$, $R_{GEN} = 25\ \Omega$	N-Ch		6	20	nS
			P-Ch		14	20	
t_r	Turn - On Rise Time		N-Ch		6	20	
			P-Ch		6	20	
$t_{D(off)}$	Turn - Off Delay Time	P-Channel $V_{DD} = -25\text{ V}$, $I_D = -0.25\text{ A}$, $V_{GS} = -10\text{ V}$, $R_{GEN} = 25\ \Omega$	N-Ch		11	20	
			P-Ch		13	20	
t_f	Turn - Off Fall Time		N-Ch		5	20	
			P-Ch		6	20	
Q_g	Total Gate Charge	N-Channel $V_{DS} = 25\text{ V}$, $I_D = 0.51\text{ A}$, $V_{GS} = 10\text{ V}$	N-Ch		1		nC
			P-Ch		1.3		
Q_{gs}	Gate-Source Charge		N-Ch		0.19		nC
		P-Channel $V_{DS} = -25\text{ V}$, $I_D = -0.34\text{ A}$, $V_{GS} = -10\text{ V}$	P-Ch		0.23		
Q_{gd}	Gate-Drain Charge		N-Ch		0.33		nC
			P-Ch		0.38		

DRAIN-SOURCE DIODE CHARACTERISTICS

I_S	Maximum Continuous Source Current		N-Ch			0.51	A
			P-Ch			-0.34	
I_{SM}	Maximum Pulse Source Current (Note 2)		N-Ch			1.5	A
			P-Ch			-1	
V_{SD}	Drain-Source Diode Forward Voltage	$V_{GS} = 0\text{ V}$, $I_S = 0.51\text{ A}$ (Note 2)	N-Ch		0.8	1.2	V
		$V_{GS} = 0\text{ V}$, $I_S = -0.34\text{ A}$ (Note 2)	P-Ch		-0.8	-1.2	

Notes:

- $R_{\theta JA}$ is the sum of the junction-to-case and case-to-ambient thermal resistance where the case thermal reference is defined as the solder mounting surface of the drain pins. $R_{\theta JC}$ is guaranteed by design while $R_{\theta CA}$ is determined by the user's board design.

$$P_D(t) = \frac{T_J - T_A}{R_{\theta JA}(t)} = \frac{T_J - T_A}{R_{\theta JC} + R_{\theta CA}(t)} = I_D^2(t) \times R_{DS(on)} \theta_{TJ}$$

Typical $R_{\theta JA}$ for single device operation using the board layouts shown below on 4.5"x5" FR-4 PCB in a still air environment:

- 130°C/W when mounted on a 0.125 in² pad of 2oz copper.
- 140°C/W when mounted on a 0.005 in² pad of 2oz copper.
- 180°C/W when mounted on a 0.0015 in² pad of 2oz copper.

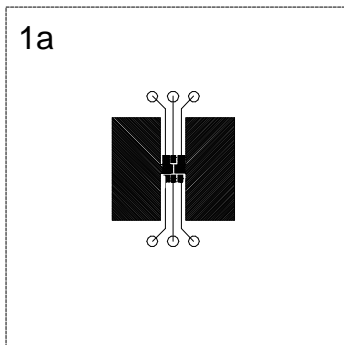

Scale 1 : 1 on letter size paper

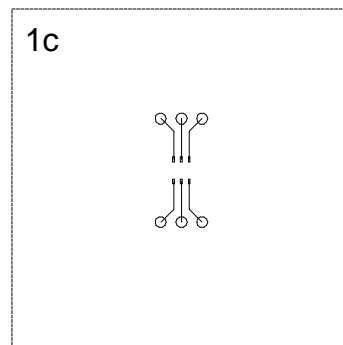
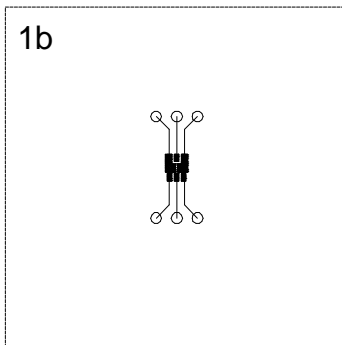

- Pulse Test: Pulse Width $\leq 300\mu\text{s}$, Duty Cycle $\leq 2.0\%$.

Typical Electrical Characteristics: N-Channel

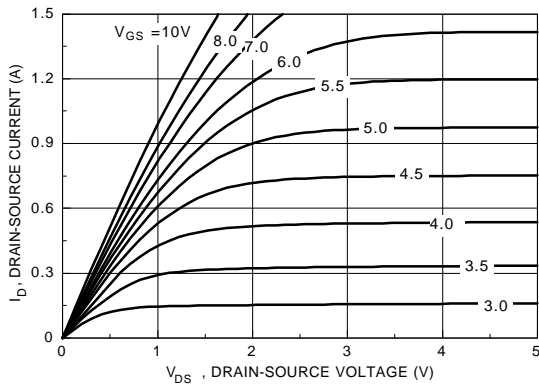

Figure 1. N-Channel On-Region Characteristics.

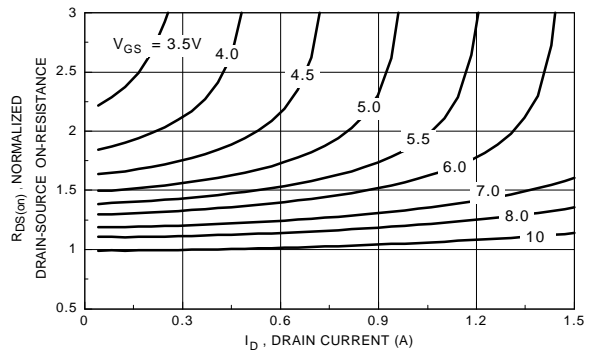

Figure 2. N-Channel On-Resistance Variation with Gate Voltage and Drain Current.

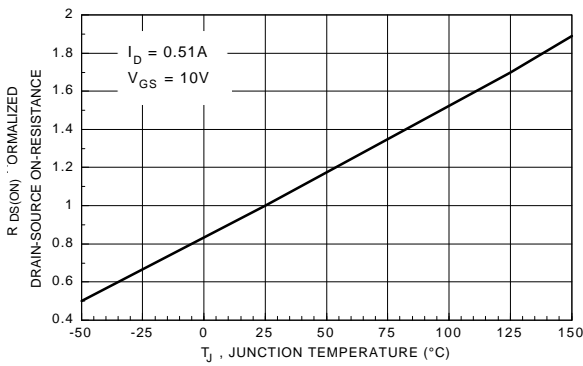

Figure 3. N-Channel On-Resistance Variation with Temperature.

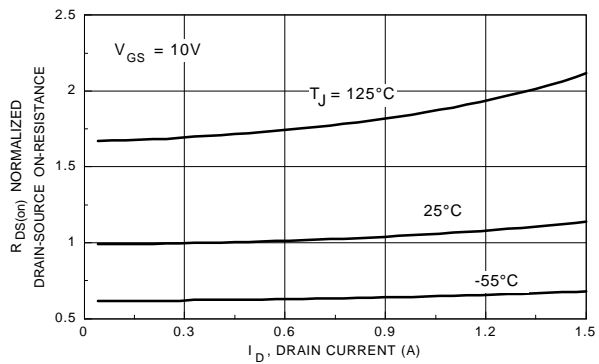

Figure 4. N-Channel On-Resistance Variation with Drain Current and Temperature.

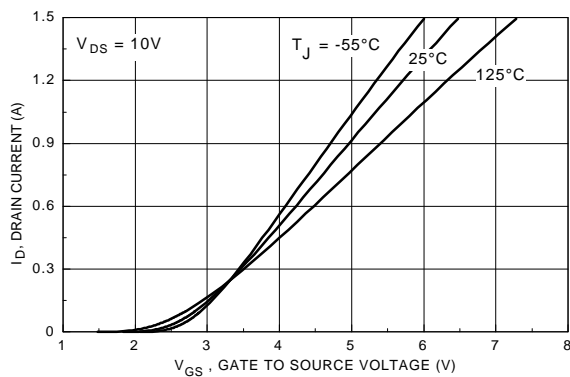

Figure 5. N-Channel Transfer Characteristics.

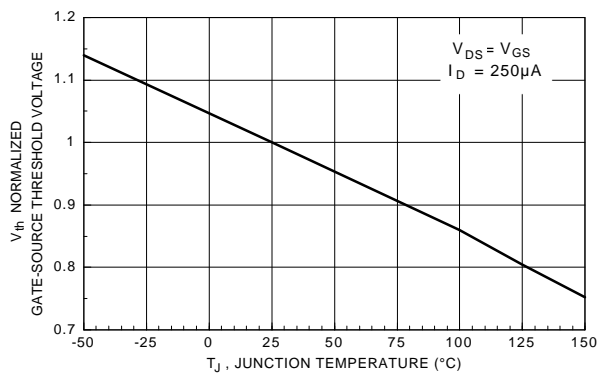

Figure 6. N-Channel Gate Threshold Variation with Temperature.

Typical Electrical Characteristics: N-Channel (continued)

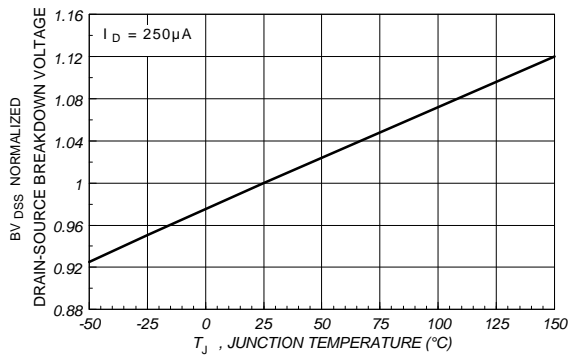

Figure 7. N-Channel Breakdown Voltage Variation with Temperature.

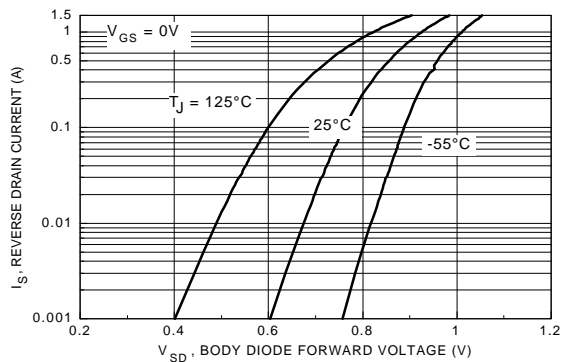

Figure 8. N-Channel Body Diode Forward Voltage Variation with Current and Temperature.

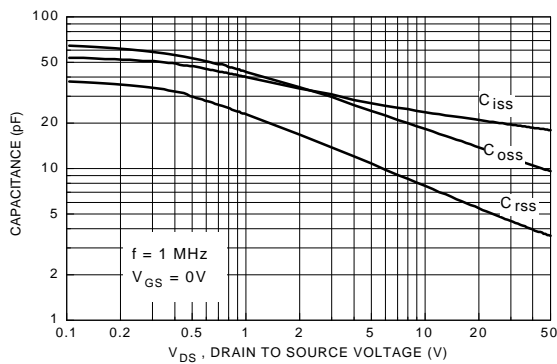

Figure 9. N-Channel Capacitance Characteristics.

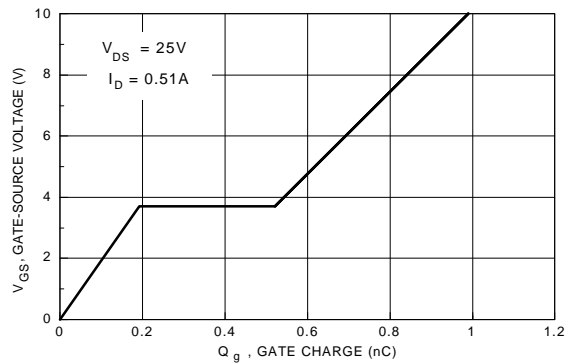

Figure 10. N-Channel Gate Charge Characteristics.

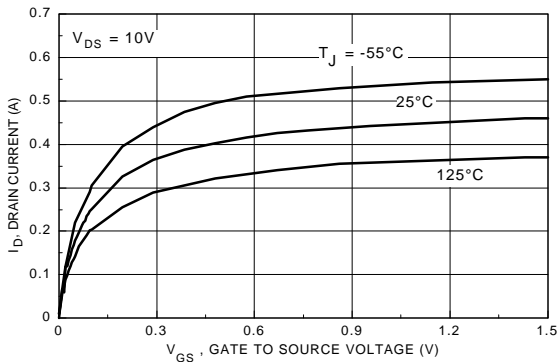

Figure 11. N-Channel Transconductance Variation with Drain Current and Temperature.

Typical Electrical Characteristics: P-Channel (continued)

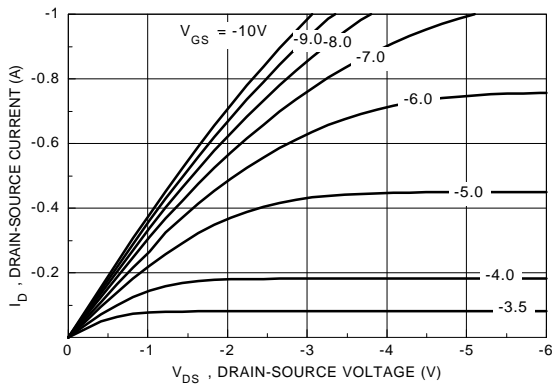

Figure 12. P-Channel On-Region Characteristics.

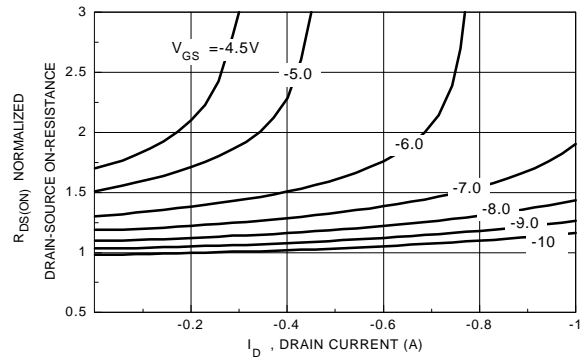

Figure 13. P-Channel On-Resistance Variation with Gate Voltage and Drain Current.

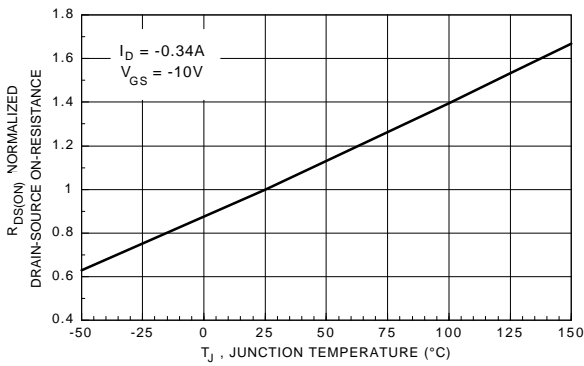

Figure 14. P-Channel On-Resistance Variation with Temperature.

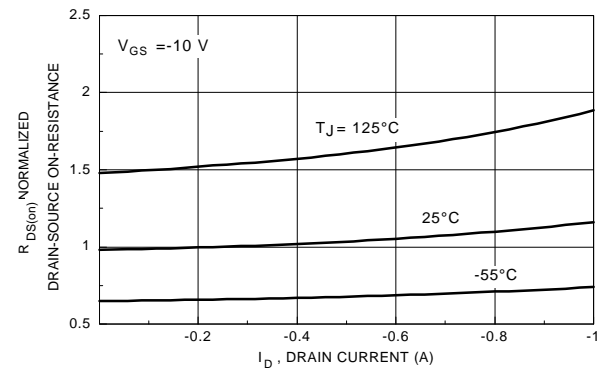

Figure 15. P-Channel On-Resistance Variation with Drain Current and Temperature.

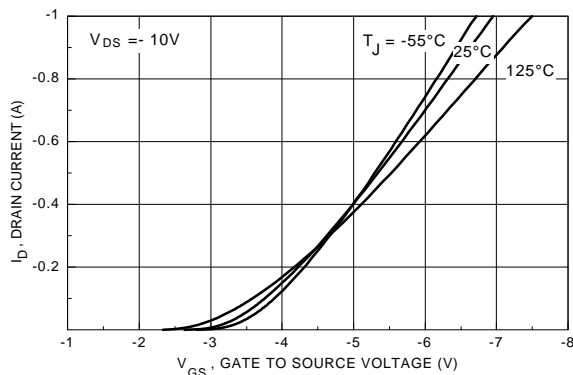

Figure 16. P-Channel Transfer Characteristics.

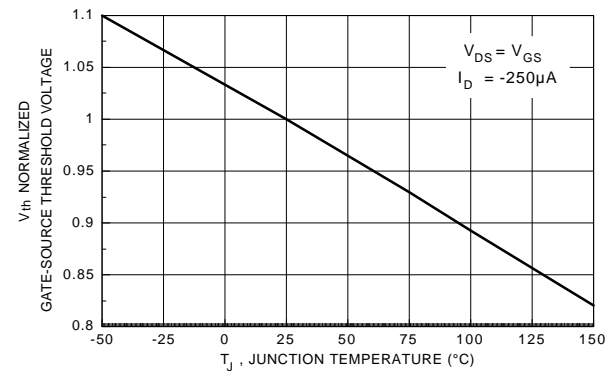

Figure 17. P-Channel Gate Threshold Variation with Temperature.

Typical Electrical Characteristics: P-Channel (continued)

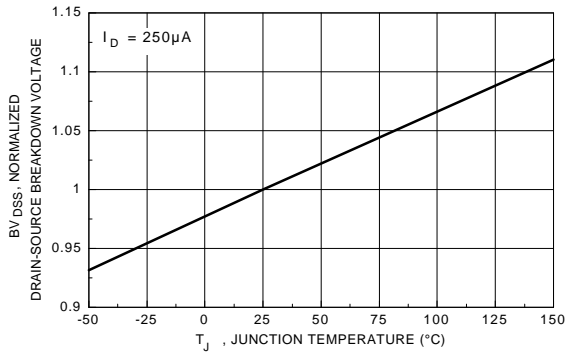

Figure 18. P-Channel Breakdown Voltage Variation with Temperature.

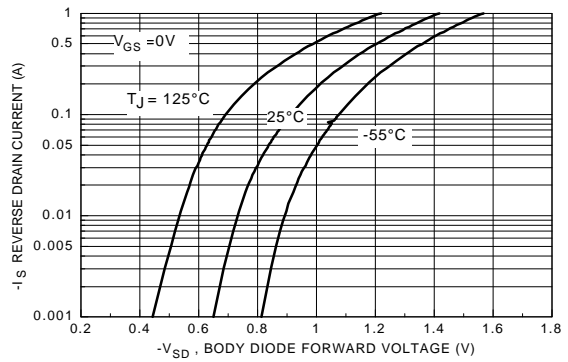

Figure 19. P-Channel Body Diode Forward Voltage Variation with Current and Temperature.

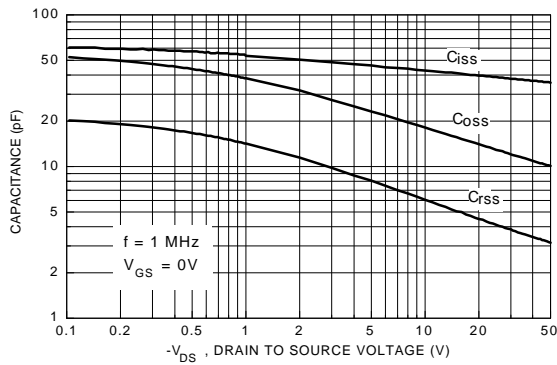

Figure 20. P-Channel Capacitance Characteristics.

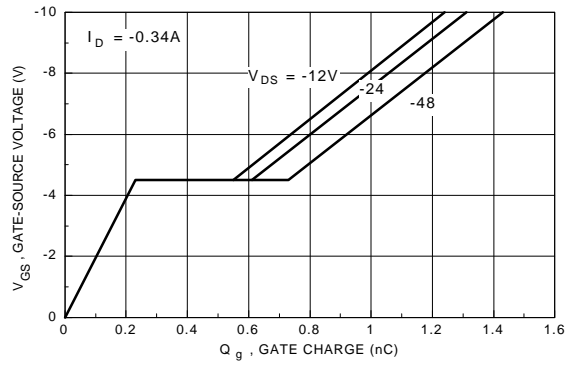

Figure 21. P-Channel Gate Charge Characteristics.

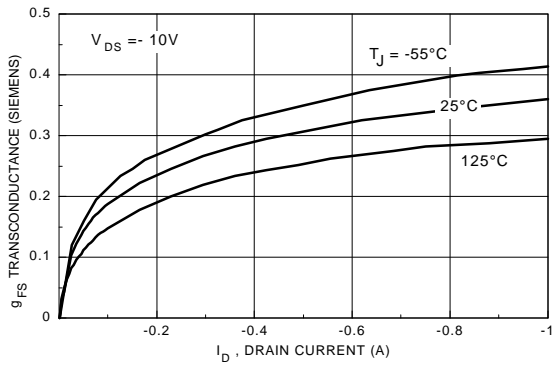

Figure 22. P-Channel Transconductance Variation with Drain Current and Temperature.

Typical Thermal Characteristics: N & P-Channel

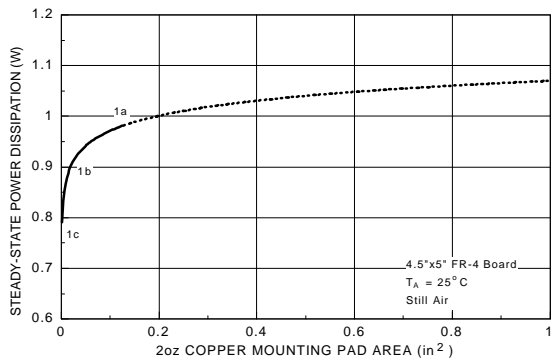

Figure 23. SOT-6 Dual Package Maximum Steady-State Power Dissipation versus Copper Mounting Pad Area.

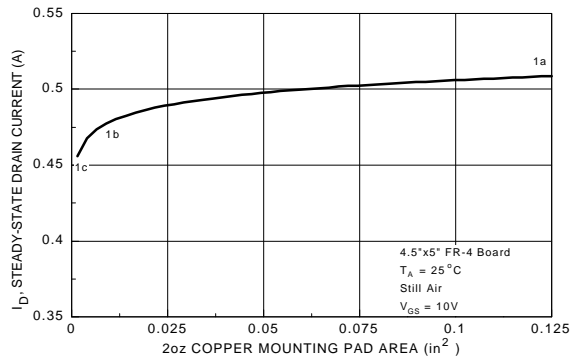

Figure 24. N-Ch Maximum Steady-State Drain Current versus Copper Mounting Pad Area.

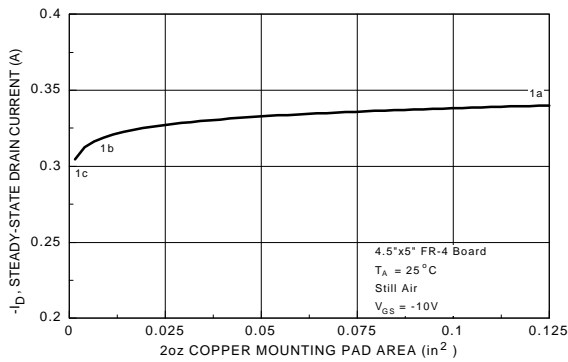

Figure 25. P-Ch Maximum Steady-State Drain Current versus Copper Mounting Pad Area.

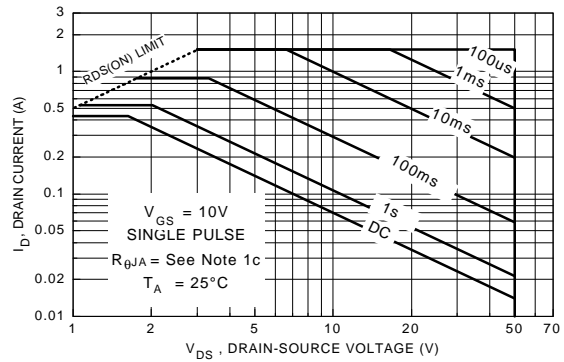

Figure 26. N-Channel Maximum Safe Operating Area.

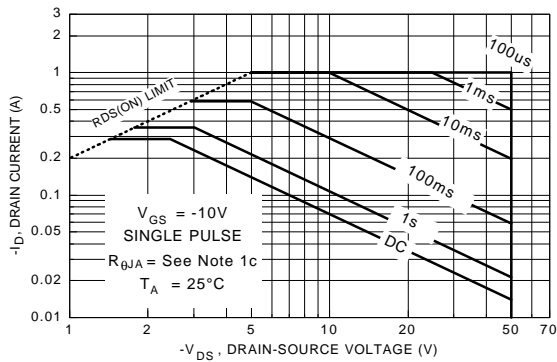

Figure 27. P-Channel Maximum Safe Operating Area.

Typical Thermal Characteristics: N & P-Channel

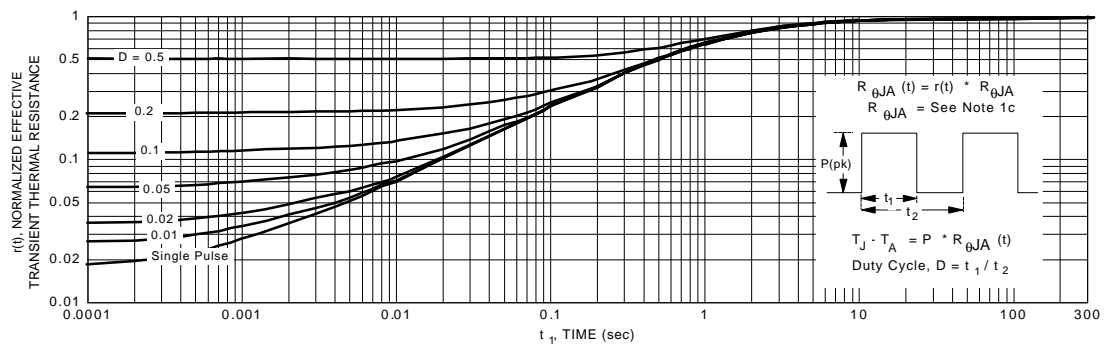

Figure 28. Transient Thermal Response Curve.

Note: Thermal characterization performed using the conditions described in note 1c. Transient thermal response will change depending on the circuit board design.

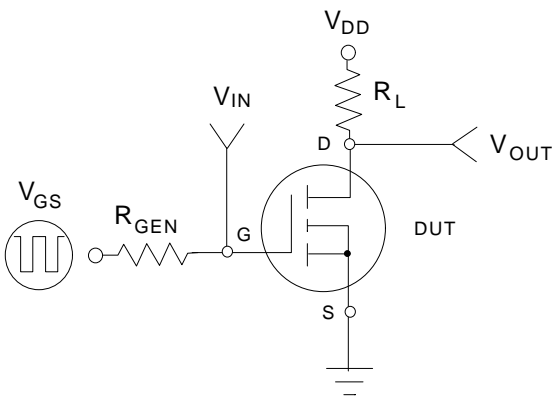

Figure 29. N or P-Channel Switching Test Circuit.

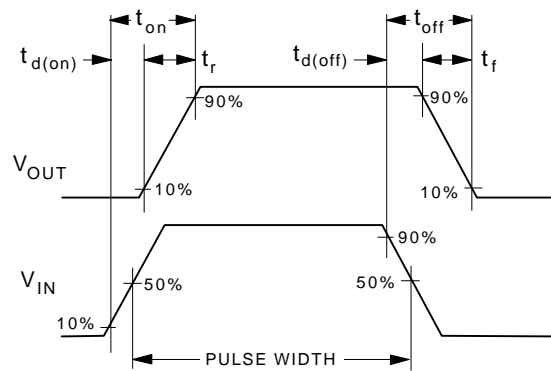
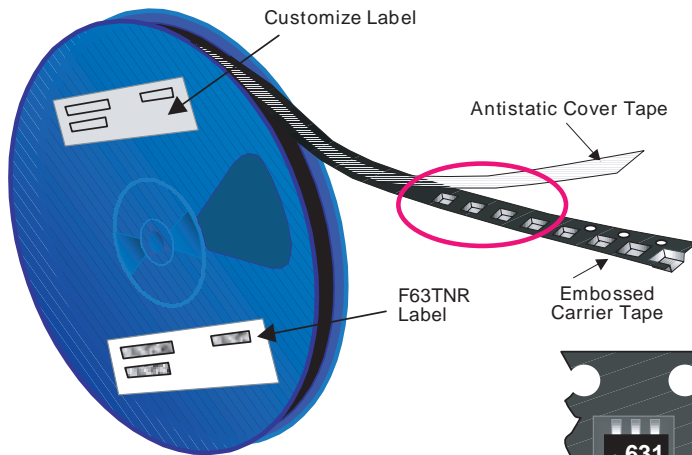

Figure 30. N or P-Channel Switching Waveforms.

SuperSOT™-6 Tape and Reel Data and Package Dimensions



SSOT-6 Packaging Configuration: Figure 1.0



Packaging Description:

SSOT-6 parts are shipped in tape. The carrier tape is made from a dissipative (carbon filled) polycarbonate resin. The cover tape is a multilayer film (Heat Activated Adhesive in nature) primarily composed of polyester film, adhesive layer, sealant, and anti-static sprayed agent. These reeled parts in standard option are shipped with 3,000 units per 7" or 177cm diameter reel. The reels are dark blue in color and is made of polystyrene plastic (anti-static coated). Other option comes in 10,000 units per 13" or 330cm diameter reel. This and some other options are described in the Packaging Information table.

These full reels are individually barcode labeled and placed inside a pizza box (illustrated in figure 1.0) made of recyclable corrugated brown paper with a Fairchild logo printing. One pizza box contains three reels maximum. And these pizza boxes are placed inside a barcode labeled shipping box which comes in different sizes depending on the number of parts shipped.

SSOT-6 Packaging Information		
Packaging Option	Standard (no flow code)	D87Z
Packaging type	TNR	TNR
Qty per Reel/Tube/Bag	3,000	10,000
Reel Size	7" Dia	13"
Box Dimension (mm)	184x187x47	343x343x64
Max qty per Box	9,000	30,000
Weight per unit (gm)	0.0158	0.0158
Weight per Reel (kg)	0.1440	0.4700
Note/Comments		

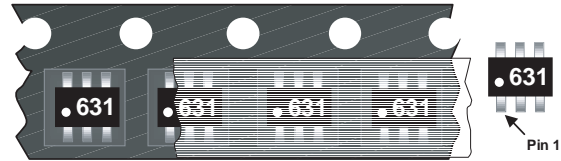

SSOT-6 Unit Orientation

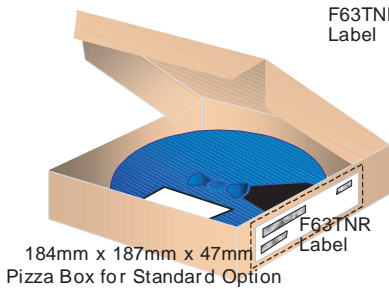
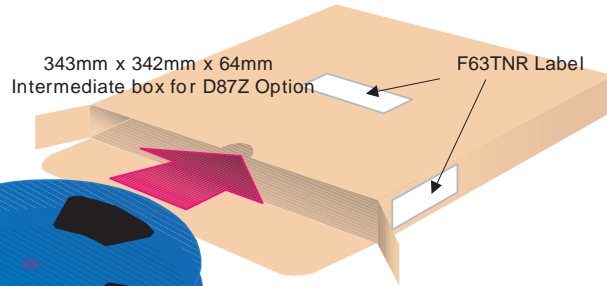

F63TNR Label sample



SSOT-6 Tape Leader and Trailer Configuration: Figure 2.0

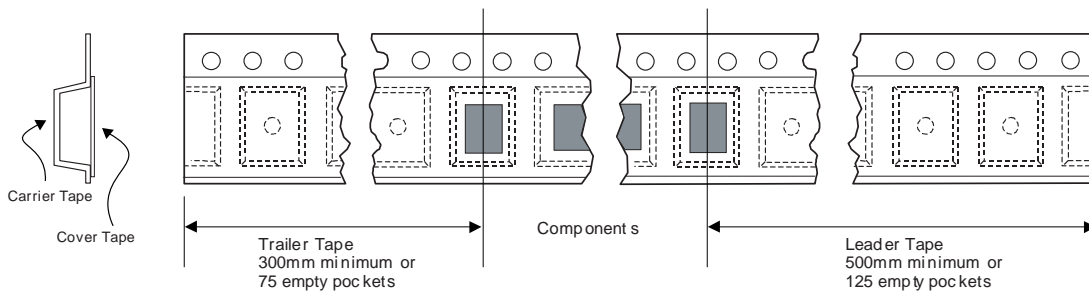

SuperSOT™-6 Tape and Reel Data and Package Dimensions, continued

SSOT-6 Embossed Carrier Tape Configuration: Figure 3.0

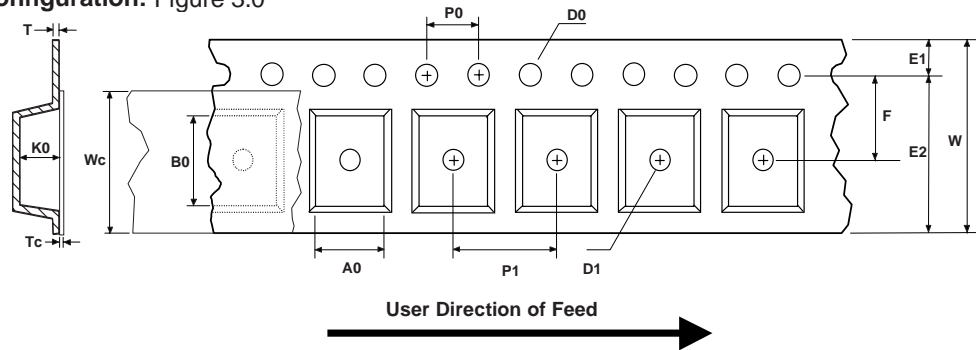

Dimensions are in millimeter

Pkg type	A0	B0	W	D0	D1	E1	E2	F	P1	P0	K0	T	Wc	Tc
SSOT-6 (8mm)	3.23 +/-0.10	3.18 +/-0.10	8.0 +/-0.3	1.55 +/-0.05	1.125 +/-0.125	1.75 +/-0.10	6.25 min	3.50 +/-0.05	4.0 +/-0.1	4.0 +/-0.1	1.37 +/-0.10	0.255 +/-0.150	5.2 +/-0.3	0.06 +/-0.02

Notes: A0, B0, and K0 dimensions are determined with respect to the EIA/Jedec RS-481 rotational and lateral movement requirements (see sketches A, B, and C).

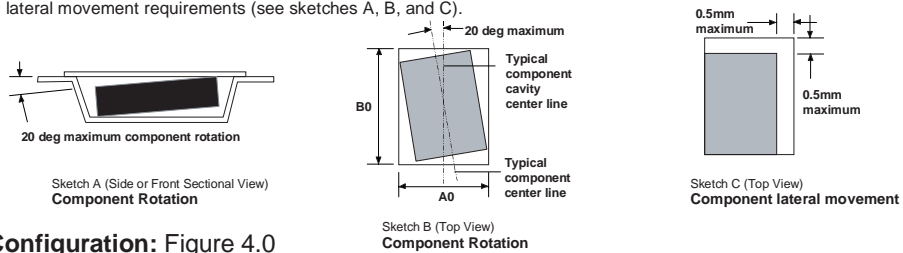

SSOT-6 Reel Configuration: Figure 4.0

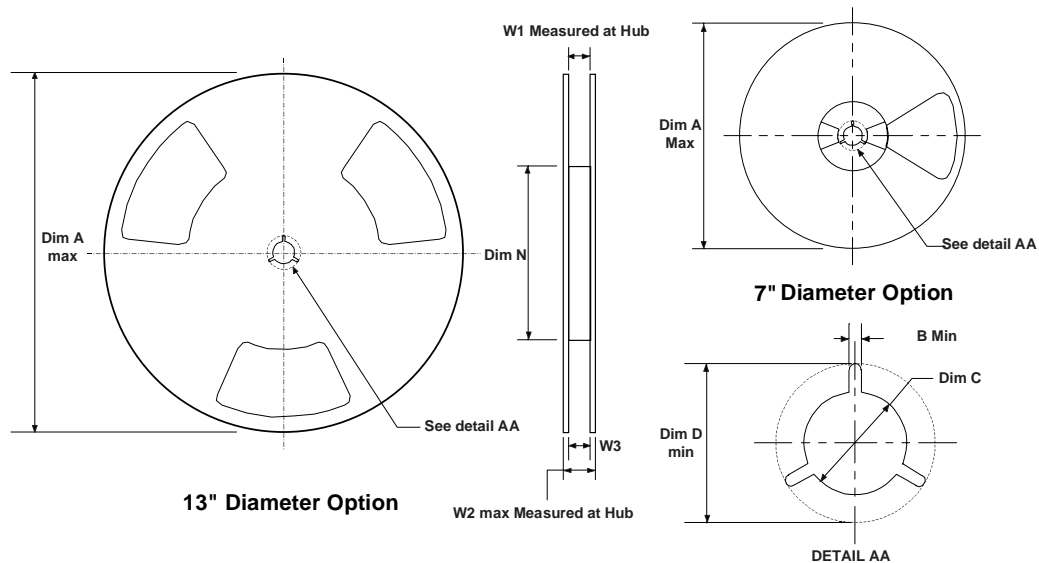

Dimensions are in inches and millimeters

Tape Size	Reel Option	Dim A	Dim B	Dim C	Dim D	Dim N	Dim W1	Dim W2	Dim W3 (LSL-USL)
8mm	7" Dia	7.00 177.8	0.059 1.5	512 +0.020/-0.008 13 +0.5/-0.2	0.795 20.2	2.165 55	0.331 +0.059/-0.000 8.4 +1.5/0	0.567 14.4	0.311 - 0.429 7.9 - 10.9
8mm	13" Dia	13.00 330	0.059 1.5	512 +0.020/-0.008 13 +0.5/-0.2	0.795 20.2	4.00 100	0.331 +0.059/-0.000 8.4 +1.5/0	0.567 14.4	0.311 - 0.429 7.9 - 10.9

SuperSOT™-6 Tape and Reel Data and Package Dimensions, continued

SuperSOT -6 (FS PKG Code 31, 33)

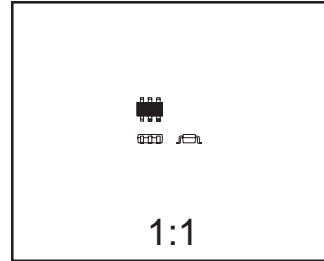
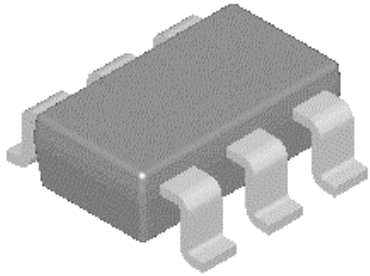

Scale 1:1 on letter size paper

Dimensions shown below are in:
inches [millimeters]

Part Weight per unit (gram): 0.0158

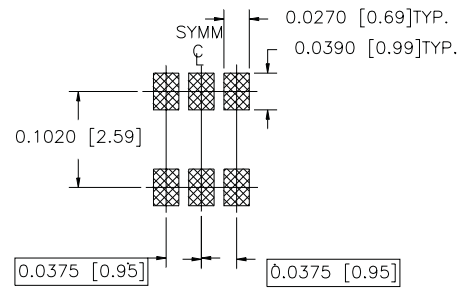
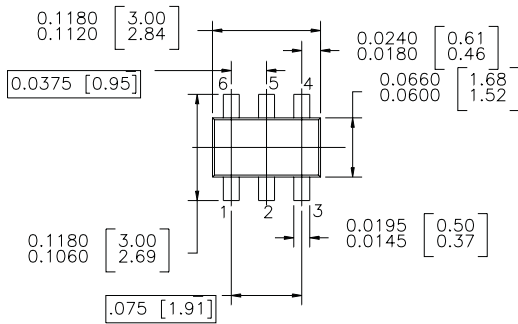

LAND PATTERN RECOMMENDATION

CONTROLLING DIMENSION IS INCH
VALUES IN [] ARE MILLIMETERS

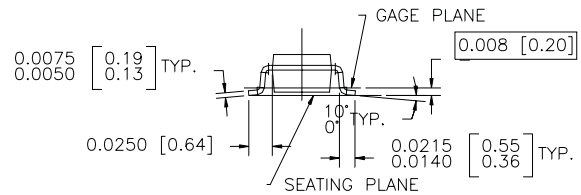
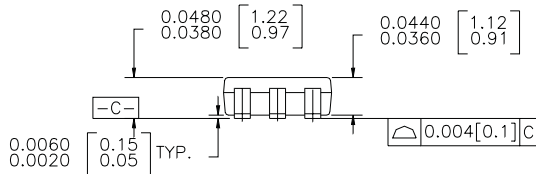

SUPER SOT 6 LEADS

NOTES : UNLESS OTHERWISE SPECIFIED

1.0 STANDARD LEAD FINISH : 150 MICRINCHES 93.81 MICROMETERS)
MINIMUM TIN / LEAD (SOLDER) ON COPPER.

2.0 NO JEDEC REGISTRATION AS OF JULY 1996

TRADEMARKS

The following are registered and unregistered trademarks Fairchild Semiconductor owns or is authorized to use and is not intended to be an exhaustive list of all such trademarks.

ACEx™	ISOPLANAR™	SyncFET™
CoolFET™	MICROWIRE™	TinyLogic™
CROSSVOLT™	POP™	UHC™
E ² CMOS™	PowerTrench®	VCX™
FACT™	QFET™	
FACT Quiet Series™	QS™	
FAST®	Quiet Series™	
FASTr™	SuperSOT™-3	
GTO™	SuperSOT™-6	
HiSeC™	SuperSOT™-8	

DISCLAIMER

FAIRCHILD SEMICONDUCTOR RESERVES THE RIGHT TO MAKE CHANGES WITHOUT FURTHER NOTICE TO ANY PRODUCTS HEREIN TO IMPROVE RELIABILITY, FUNCTION OR DESIGN. FAIRCHILD DOES NOT ASSUME ANY LIABILITY ARISING OUT OF THE APPLICATION OR USE OF ANY PRODUCT OR CIRCUIT DESCRIBED HEREIN; NEITHER DOES IT CONVEY ANY LICENSE UNDER ITS PATENT RIGHTS, NOR THE RIGHTS OF OTHERS.

LIFE SUPPORT POLICY

FAIRCHILD'S PRODUCTS ARE NOT AUTHORIZED FOR USE AS CRITICAL COMPONENTS IN LIFE SUPPORT DEVICES OR SYSTEMS WITHOUT THE EXPRESS WRITTEN APPROVAL OF FAIRCHILD SEMICONDUCTOR CORPORATION. As used herein:

1. Life support devices or systems are devices or systems which, (a) are intended for surgical implant into the body, or (b) support or sustain life, or (c) whose failure to perform when properly used in accordance with instructions for use provided in the labeling, can be reasonably expected to result in significant injury to the user.
2. A critical component is any component of a life support device or system whose failure to perform can be reasonably expected to cause the failure of the life support device or system, or to affect its safety or effectiveness.

PRODUCT STATUS DEFINITIONS

Definition of Terms

Datasheet Identification	Product Status	Definition
Advance Information	Formative or In Design	This datasheet contains the design specifications for product development. Specifications may change in any manner without notice.
Preliminary	First Production	This datasheet contains preliminary data, and supplementary data will be published at a later date. Fairchild Semiconductor reserves the right to make changes at any time without notice in order to improve design.
No Identification Needed	Full Production	This datasheet contains final specifications. Fairchild Semiconductor reserves the right to make changes at any time without notice in order to improve design.
Obsolete	Not In Production	This datasheet contains specifications on a product that has been discontinued by Fairchild semiconductor. The datasheet is printed for reference information only.